

SPRINTIS



Edition 5.1



Dear Customer,

What you hold in your hands today is the latest version of our catalog – edition 5.1. The modifications in the warehouse and shipping areas have had the desired effect, and we are able to optimize our product range, and with it our delivery performance, even more with you in mind. The result: numerous new products, which you will already see featured in this new edition. Our heavily trafficked online shop is also currently being overhauled to make your purchasing process clearer and simpler. You might even notice the first few changes when edition 5.1 is published.

In short, we are in motion here at SPRINTIS, as always. From new expansions in the area of personnel to plans for new buildings and storage capacity and beyond, including our expansion to the Benelux countries – standing still just isn't our thing. Instead, we are driven by the desire to successfully realize your wishes and meet growing demands.

Quality, advice, free delivery of samples, delivery performance, and – last but not least – good value for the price: We are always pleased to lead the pack, and we are delighted to be able to present a small sign of our efforts today, in edition 5.1! Our product specialists are happy to speak with you in person for any questions or suggestions you may have.



Christian Schenk
Geschäftsführer
CEO

PS: For complete up-to-date product pricing and online purchases, please see our online shop at www.sprintis.eu.

Liebe Kunden,

heute halten Sie die neueste Fassung unseres Katalogs in den Händen – die Edition 5.1. Die Umbauten im Bereich Lager und Versand zeigen die erhofften Auswirkungen und wir sind in der Lage unser Sortiment und somit die Lieferperformance noch weiter in Ihrem Sinne zu optimieren. Das Ergebnis: zahlreiche neue Produkte, die Sie hier in dieser neuen Edition bereits finden können. Auch unser stark frequentierter Onlineshop befindet sich derzeit auf einer Modernisierungskur, um Ihren Einkauf übersichtlicher und einfacher zu gestalten. Vielleicht sehen Sie zum Erscheinen der Edition 5.1. schon erste Änderungen.

Kurz gesagt, wie immer sind wir bei SPRINTIS in Bewegung. Ob erneute Erweiterungen im Bereich Personal, Pläne für neue Gebäude und Lagerkapazitäten oder die Expansion nach den BeNeLux-Staaten – Stillstand ist nicht unser Steckbrief. Vielmehr treibt uns der Wunsch an, Ihre Wünsche und wachsenden Ansprüche erfolgreich zu realisieren.

Qualität, Beratung, kostenloser Musterversand, Lieferperformance und nicht zuletzt preiswerte Konditionen, wir sind gerne immer ganz vorne dabei und wir freuen uns, Ihnen heute mit der Edition 5.1 einen kleinen Beweis unserer Bemühungen präsentieren zu dürfen! Unsere Produktspezialisten stehen Ihnen bei Fragen und Anregungen weiterhin gerne persönlich zur Verfügung.



Matthias Schenk
Geschäftsführer
CEO

PS: In unserem Onlineshop www.sprintis.de können Sie Preise aller Artikel abrufen und auf Wunsch direkt online bestellen.



Heftmechaniken & Zubehör

File prongs & accessories

1.

Heftmechaniken mit Abheftvorrichtung _____	1.1	Kunststoffdeckleisten _____	1.3
<i>File prongs with additional file systems</i> _____	1.1	<i>Plastic compressor bars</i> _____	1.3
Heftmechaniken ohne Abheftvorrichtung _____	1.1	Hakendeckleiste _____	1.4
<i>File prongs without file system</i> _____	1.1	<i>Hook compressor bars</i> _____	1.4
Abdeckschienen für Heftmechaniken _____	1.1	Abheftvorrichtungen mit 4 Ösen _____	1.4
<i>Cover strips for file prongs</i> _____	1.1	<i>Plastic fasteners with 4 eyelets</i> _____	1.4
Heftzungen _____	1.2	Rechtecktaschen für Abheftvorrichtungen _____	1.4
<i>File prongs</i> _____	1.2	<i>Pockets for plastic fasteners with 2 eyelets</i> _____	1.4
Heftzungen, selbstklebend _____	1.2	Heftverschlüsse mit Schieberdeckleiste _____	1.5
<i>File prongs, self-adhesive</i> _____	1.2	<i>Metal file fittings</i> _____	1.5
Doppelspiralfeder _____	1.2	Schlauchmechaniken _____	1.5
<i>Double spiral spring</i> _____	1.2	<i>Tube mechanics</i> _____	1.5
Abheftvorrichtungen mit 2 Ösen _____	1.3	Archivclips _____	1.5
<i>Plastic fasteners with 2 eyelets</i> _____	1.3	<i>Archive clips</i> _____	1.5

Selbstklebende Klarsichttaschen

Self-adhesive pockets

2.

Dreiecktaschen, ungleichschenkelig _____	2.1	Rechtecktaschen _____	2.3
<i>Corner pockets, unequal-sided</i> _____	2.1	<i>Rectangular pockets</i> _____	2.3
Dreiecktaschen, gleichschenkelig _____	2.1	Visitenkartentaschen _____	2.4
<i>Corner pockets, isosceles triangular</i> _____	2.1	<i>Business card pockets</i> _____	2.4
Dreiecktaschen aus Papier _____	2.2	Rückenschildtaschen _____	2.4
<i>Corner pockets, paper</i> _____	2.2	<i>Spine label pockets</i> _____	2.4
Dreiecktaschen mit aufgeschweißter Visitenkartentasche _____	2.2	Visitenkartentaschen / Rechtecktaschen nach Kundenwunsch _____	2.5
<i>Corner pockets with welded-on pocket for business cards</i> _____	2.2	<i>Business card and rectangular pockets - customised</i> _____	2.5
Dreiecktaschen nach Kundenwunsch _____	2.2		
<i>Corner pockets - customised</i> _____	2.2		

CD-Halter, CD-Taschen, Digitrays

CD / DVD storage and mounting

3.

CD-Halter aus Schaumstoff _____	3.1	CD-Taschen nach Kundenwunsch _____	3.2
<i>CD foam studs</i> _____	3.1	<i>CD pockets - customised</i> _____	3.2
CD-Clips _____	3.1	CD-Ablagehüllen _____	3.3
<i>CD holders</i> _____	3.1	<i>CD filing pockets</i> _____	3.3
CD-Taschen _____	3.2	CD-Trays _____	3.3
<i>CD pockets</i> _____	3.2	<i>Digitrays</i> _____	3.3

Kalenderzubehör

Calendar accessories

4.

Datumsweiser mit Knebelgummi _____	4.1	Plakatpieker nach Kundenwunsch _____	4.4
<i>Date indicators for three-month calendar with elastic cord</i> _____	4.1	<i>Poster pins - customised</i> _____	4.4
Datumsweiser für Tischkalender _____	4.2	Datums- oder Aktenklammern _____	4.5
<i>Date indicators for desk calendar</i> _____	4.2	<i>Date or file clips</i> _____	4.5
Ringmagnet als Datumsweiser, inkl. Metallronden _____	4.2	Pfeilclip _____	4.6
<i>Ring magnets used as date indicators, incl. metal discs</i> _____	4.2	<i>Arrow clips</i> _____	4.6
Statische Datumsweiser _____	4.2	Pfeilclips nach Kundenwunsch _____	4.6
<i>Static date indicators</i> _____	4.2	<i>Arrow clips - customised</i> _____	4.6
Kalenderboxen _____	4.3	Plakataufhänger _____	4.6
<i>Calendar boxes</i> _____	4.3	<i>Poster hangers</i> _____	4.6
Schutzkanten für Schreibtischblocks DIN A2 _____	4.3	Kalenderaufhänger _____	4.7
<i>Cover strips for A2 desk pads</i> _____	4.3	<i>Calendar hangers</i> _____	4.7
Schutzkanten für Schreibtischblocks nach Kundenwunsch _____	4.3	Schafte für Kalenderaufhänger _____	4.7
<i>Cover strips for desk pads - customised</i> _____	4.3	<i>Straight wire shafts for calendar hangers</i> _____	4.7
Plakatpieker _____	4.4		
<i>Poster pins</i> _____	4.4		



Klebeunkte & Klebeband

Adhesive discs & tapes

5.

Einseitige Klebeunkte, transparent _____	5.1	Elektronischer Klebebandspeicher A1200 _____	5.10
<i>Single-sided adhesive discs, transparent</i> _____	5.1	<i>Electronic dispenser for adhesive tapes A1200</i> _____	5.10
Einseitige Klebeunkte nach Kundenwunsch _____	5.2	Doppelseitiges Klebeband _____	5.10
<i>Adhesive discs - customised</i> _____	5.2	<i>Double-sided adhesive tape</i> _____	5.10
Spender für Klebeunkte _____	5.2	Doppelseitiges Klebeband, stark / schwach _____	5.10
<i>Dispenser for self-adhesive discs</i> _____	5.2	<i>Double-sided adhesive tape, permanent/removable</i> _____	5.10
Spenderbox für einseitige Klebeunkte _____	5.2	Doppelseitiges Klebeband High-Performance _____	5.11
<i>Dispenser box for adhesive discs</i> _____	5.2	<i>Double-sided adhesive tape high performance</i> _____	5.11
Handabroller System für einseitige Klebeunkte _____	5.3	Doppelseitiges Klebeband 3M 9086 _____	5.11
<i>Hand dispenser system for single-side adhesive discs</i> _____	5.3	<i>Double-sided adhesive tape 3M 9086</i> _____	5.11
Aktionsetiketten _____	5.3	Doppelseitiges Klebeband Fingerlift _____	5.12
<i>Sales labels</i> _____	5.3	<i>Double-sided adhesive tape with fingerlift</i> _____	5.12
Farbige Klebeunkte _____	5.4	Doppelseitiges Hochleistungs-Klebeband, PET Folienträger _____	5.12
<i>Coloured adhesive discs</i> _____	5.4	<i>Double-sided high performance adhesive tape, PET foil</i> _____	5.12
Doppelseitige Klebeunkte, transparent _____	5.5	Doppelseitiges Hochleistungs-Klebeband 3M 9088 _____	5.12
<i>Double-sided adhesive discs, transparent</i> _____	5.5	<i>Double-sided high performance adhesive tape 3M 9088</i> _____	5.12
Doppelseitige Klebeunkte aus Reinacrylat, hochtransparent _____	5.6	Doppelseitiges Hochleistungs-Klebeband, PVC Folienträger _____	5.13
<i>Double-sided adhesive discs acrylic foam, highly transparent</i> _____	5.6	<i>Double-sided high performance adhesive tape, PVC foil</i> _____	5.13
Doppelseitige Klebeunkte aus PE-Schaum, weiß _____	5.6	Doppelseitiges Hochleistungs-Klebeband 3M 9087 _____	5.13
<i>Double-sided adhesive discs PE foam, white</i> _____	5.6	<i>Double-sided high performance adhesive tape 3M 9087</i> _____	5.13
Doppelseitige Klebeunkte nach Kundenwunsch _____	5.7	Doppelseitiges Reinacrylat-Klebeband _____	5.13
<i>Double-sided adhesive discs - customised</i> _____	5.7	<i>Double-sided acrylic foam tape</i> _____	5.13
Gewebeklebeunkte _____	5.7	Doppelseitiges Klebeband PE-Schaum _____	5.14
<i>Fabric adhesive discs</i> _____	5.7	<i>Double-sided adhesive tape PE foam</i> _____	5.14
Silikonklebeunkte für Handabroller _____	5.7	Doppelseitiges Klebeband nach Kundenwunsch _____	5.14
<i>Glue dots for tape gun</i> _____	5.7	<i>Double-sided adhesive tape - customised</i> _____	5.14
Silikonklebeunkte _____	5.8	PP-Packband, fadenverstärkt _____	5.15
<i>Glue dots</i> _____	5.8	<i>Packaging tape, reinforced</i> _____	5.15
Klebespender / Einwegroller _____	5.8	PP-Packband _____	5.15
<i>Tape dispenser</i> _____	5.8	<i>Packaging tape</i> _____	5.15
Transferklebeband für ATG-System _____	5.9	Handabroller PREMIUM für Packbänder _____	5.15
<i>Transfer tapes for ATG adhesive system</i> _____	5.9	<i>Hand-held tape dispenser PREMIUM for packaging tapes</i> _____	5.15

Klettunkte & Klettband

Hook & loop fasteners

6.

Klettunkte _____	6.1	Klettbandabschnitte, selbstklebend _____	6.2
<i>Hook and loop fasteners - coins</i> _____	6.1	<i>Hook and loop fasteners, self-adhesive</i> _____	6.2
Klettunkte, extra-dünn _____	6.1	Klettband zum Vernähen _____	6.3
<i>Hook and loop fasteners - coins, extra thin</i> _____	6.1	<i>Hook and loop fasteners - tape for sewing</i> _____	6.3
Klett-Ellipsen _____	6.1	Klettband, back to back _____	6.3
<i>Hook and loop fasteners - ellipses</i> _____	6.1	<i>Hook and loop fasteners, back to back</i> _____	6.3
Klettband, selbstklebend _____	6.2	Klettbänder + Klettunkte nach Kundenwunsch _____	6.4
<i>Hook and loop fasteners - tape, self-adhesive</i> _____	6.2	<i>Hook and loop fasteners - tapes and coins - customised</i> _____	6.4

Magnete & Magnetband

Magnets & magnetic tape

7.

Scheibenmagnete aus Neodym _____	7.1	Metallronden _____	7.3
<i>Magnetic discs neodymium</i> _____	7.1	<i>Metal discs</i> _____	7.3
Selbstklebende Scheibenmagnete aus Neodym _____	7.2	Würfelmagnete aus Neodym _____	7.4
<i>Self-adhesive magnetic discs neodymium</i> _____	7.2	<i>Cube magnets neodymium</i> _____	7.4
Ufo-Scheibenmagnete aus Neodym _____	7.3	Magnete aus Neodym nach Kundenwunsch _____	7.4
<i>Magnetic discs "Ufo" neodymium</i> _____	7.3	<i>Magnetic discs neodymium - customised</i> _____	7.4
Ringmagnete aus Neodym _____	7.3	Magnetband, selbstklebend _____	7.4
<i>Ring magnets neodymium</i> _____	7.3	<i>Magnetic tape, self-adhesive</i> _____	7.4



Binderücken & Zubehör

Wire bindings & accessories

8.

Drahtbinderücken, für DIN A4, 3:1 Teilung	8.1	Drahtbinderücken nach Kundenwunsch	8.6
<i>Wire bindings, for A4, 3:1 pitch</i>	8.1	<i>Wire bindings - customised</i>	8.6
Drahtbinderücken, für DIN A5, 3:1 Teilung	8.2	Foliendeckblätter	8.7
<i>Wire bindings, for A5, 3:1 pitch</i>	8.2	<i>Binding covers</i>	8.7
Drahtbinderücken, für DIN A4, 2:1 Teilung	8.3	Foliendeckblätter / Zuschnitte nach Kundenwunsch	8.7
<i>Wire bindings, for A4, 2:1 pitch</i>	8.3	<i>Binding covers - customised</i>	8.7
Drahtbinderücken, für DIN A5, 2:1 Teilung	8.4	Rückwände	8.8
<i>Wire bindings, for A5, 2:1 pitch</i>	8.4	<i>Back covers</i>	8.8
Drahtbinderücken auf Spule, 3:1 Teilung	8.5	Abheftstreifen für Draht- und Plastikbinderücken	8.8
<i>Wire bindings on spool, 3:1 pitch</i>	8.5	<i>Filing strips for wire and plastic loops binding</i>	8.8
Drahtbinderücken auf Spule, 2:1 Teilung	8.6		
<i>Wire bindings on spool, 2:1 pitch</i>	8.6		

Buchschrauben & -ecken, Ringe, Ösen & Ketten

Binding screws, rings, eyelets & chains

9.

Buchschrauben, vernickelt	9.1	Heftringe	9.10
<i>Binding screws, nickel-plated</i>	9.1	<i>Binding rings</i>	9.10
Buchschrauben, vermessingt	9.2	Warenringe	9.11
<i>Binding screws, brass-plated</i>	9.2	<i>Merchandise rings</i>	9.11
Buchschrauben, verkupfert	9.3	Schlüsselringe	9.11
<i>Binding screws, copper-plated</i>	9.3	<i>Key rings</i>	9.11
Buchschrauben, schwarz verzinkt	9.3	Aufhängeösen	9.11
<i>Binding screws, black zinc-plated</i>	9.3	<i>Binding screw hangers</i>	9.11
Verlängerungen für Buchschrauben	9.3	Metallösen, vermessingt	9.12
<i>Extensions for binding-screws</i>	9.3	<i>Eyelets, brass-plated</i>	9.12
Buchschrauben, Kopf schwarz lackiert	9.4	Metallösen, vernickelt	9.12
<i>Binding screws, black painted head</i>	9.4	<i>Eyelets, nickel-plated</i>	9.12
Buchschrauben mit Rosettenscheibe	9.4	Spindelpresse N4	9.13
<i>Binding screws with rosette disc</i>	9.4	<i>Spindle press N4</i>	9.13
Unterlegscheiben	9.5	Ös-Werkzeug für Spindelpresse N4	9.13
<i>Washers</i>	9.5	<i>Eyelet setting tool for spindle press N4</i>	9.13
Abdeckkappen für Buchschrauben	9.5	Spindelpresse N4 Set	9.13
<i>Cover caps for binding screws</i>	9.5	<i>Spindle press N4 set</i>	9.13
Trageschlaufen	9.5	Ös-Maschine M165	9.14
<i>Swatch straps</i>	9.5	<i>Eyeletting machine M165</i>	9.14
Kunststoffbuchschrauben	9.6	Ös-Werkzeug für Maschine M165	9.14
<i>Plastic binding screws</i>	9.6	<i>Eyelet setting tool for eyeletting machine M165</i>	9.14
Druckösen	9.7	Ös-Maschine M80T	9.14
<i>Snap studs</i>	9.7	<i>Eyeletting machine M80T</i>	9.14
Spezialschrauben	9.7	Ös-Maschine M80PU	9.15
<i>Extension screw tops</i>	9.7	<i>Eyeletting machine M80PU</i>	9.15
Einpressköpfe für Buchschrauben	9.8	Kugellketten auf Rolle	9.15
<i>Hammer tops for binding screws</i>	9.8	<i>Ball chain reels</i>	9.15
Kunststoffbuchschrauben mit Loch	9.8	Kugellketten, abgelängt	9.16
<i>Plastic binding screws with hole</i>	9.8	<i>Ball chains, cut-to-length</i>	9.16
Buchecken	9.9	Einhängeösen für Kugellketten	9.17
<i>Corner protectors</i>	9.9	<i>Clasps for ball chain</i>	9.17
Bucheckenzange	9.9	Einpressverschlüsse für Kugellketten	9.17
<i>Corner puncher</i>	9.9	<i>Ball chain connectors</i>	9.17
Buchecken-Werkzeug Set	9.10	Drahtseilverbinder mit Drehverschluss	9.17
<i>Setting tool for book corners</i>	9.10	<i>Wire rope connector with screw</i>	9.17



Musterbuchproduktion

Samples folder production

10.

Flachkopfnägel mit Kappe	10.1	Druckknöpfe	10.4
Patternbook nails with cover	10.1	Press fasterness	10.4
Nägel für Musterbücher	10.1	Werkzeug-Set für Kappen & Federteile der Druckknöpfe	10.4
Patternbook nails	10.1	Tool-set for cap and socket of press fasteners	10.4
C-Tragegriffe aus Metall	10.2	Druckknopfstifte	10.5
C-handles made of metal	10.2	Pillar press fasteners	10.5
Tragegriffe aus Kunststoff	10.2	Werkzeug-Set für Kunststoffschäfte & Einspitzstifte der Druckknopfstifte	10.5
Handles made of plastic	10.2	Tool-set for pillar and stud of the pillar press fasteners	10.5
Trageschlaufen aus Kunststoff	10.2	Bindestifte mit Verschlusshülse	10.6
Strap handle made of plastic	10.2	Ratchet post fasteners with tube	10.6
Kunststoff-Kollektionshaken	10.3	Bindestifte mit Verschlusscheibe	10.6
Display hooks made of plastic	10.3	Ratchet post fasteners with washer	10.6
Metall- Kollektionshaken & -platten	10.3	Konfektionsklammern	10.6
Display hooks and plates made of metal	10.3	Garment clips	10.6
Steckverschlüsse	10.4		
Locks	10.4		

Display-Artikel

Display accessories

11.

Eurolochaufhänger	11.1	Aufhängehaken	11.7
Hanging tabs	11.1	Suspension hook	11.7
Eurolochaufhänger nach Kundenwunsch	11.1	Klebpunkte mit Öse	11.8
Hanging tabs - customised	11.1	Self-adhesive pads with eyelet	11.8
Regalwippen, wippend	11.2	Decken-Cliphaken mit Öse	11.8
Wobblers	11.2	Suspended ceiling clip with eyelet	11.8
Regalwippen, biegsam	11.2	Mobile-Verbinder	11.8
Wobblers, bendable	11.2	Mobile strings	11.8
Deko-Spring	11.3	Nylonfaden auf Rolle	11.9
Spring wobblers	11.3	Nylon cord reels	11.9
Abstandshalter	11.3	Deckenspinne, verzinkt	11.9
Spacers	11.3	Suspended ceiling clip with eyelet, galvanized	11.9
Verbindungselemente	11.3	Deckenspinne, Form „8“, verzinkt	11.9
Connection elements	11.3	Suspended ceiling clip, "8" shape, galvanized	11.9
Kartenhalter	11.4	Sign-Clip - Preishalter mit Kugelgelenk	11.10
Card holders	11.4	Sign-Clip - price holder with ball joint	11.10
Flaschenringe	11.4	Bannerhalter mit Magnetbasis	11.10
Bottle rings	11.4	Banner holder with magnetic base	11.10
Sicherheitsfäden / Rasterschleife	11.5	Blisterleisten	11.10
Loop pins / Stepped loop pins	11.5	Display strips	11.10
Kordeln mit Einsteckbox	11.5	Displayhaken	11.11
Loop pins / Stepped loop pins	11.5	Display hooks	11.11
Nylonclip	11.6	Rückenstütze	11.11
Nylon clip	11.6	Back support	11.11
Abhängefedern JetSnabb	11.6	Prospekthalter L-Aufsteller	11.12
JetSnabbs	11.6	L-shaped sign holder	11.12
Haken mit Schnur	11.6	Prospekthalter T-Aufsteller	11.12
Wire hangers with cord	11.6	T-shaped sign holder	11.12
S-Haken	11.7	Displayständer	11.12
S-hooks	11.7	Brochure holder	11.12
C-Haken	11.7	Regalbodenhalter für Wellpappe-Displays	11.13
C-hooks	11.7	Shelf clips	11.13



Gummischnüre, Kordeln & Bänder

Rubber bands, cords & ribbons

12.

Rundgummi mit 2 Metallsplinten _____	12.1	Fertigschleifen maschinell an Anhängerkarten geknotet _____	12.7
<i>Round elastic cords with 2 metal T-ends</i> _____	12.1	<i>Elastic cord loops with knot on hang tag-machine-made</i> _____	12.7
Rundgummi mit 2 Metallsplinten nach Kundenwunsch _____	12.3	Abschnitte aus Gummizugschnur _____	12.7
<i>Round elastic cords with 2 metal T-ends - customised</i> _____	12.3	<i>Elastic cords, cut-to-length</i> _____	12.7
Flachgummi mit 2 Metallsplinten _____	12.3	Lederkordel auf Rolle _____	12.7
<i>Flat elastic cords with 2 metal T-ends</i> _____	12.3	<i>Leather cord on reel</i> _____	12.7
Gummizugschnüre mit Metallsplint zum Ring geschlossen _____	12.3	Ataskordeln auf Rolle _____	12.8
<i>Elastic cord rings with metal ends</i> _____	12.3	<i>Cords on reel</i> _____	12.8
Gummizugschnüre als Ring nach Kundenwunsch _____	12.4	Kordelklammern _____	12.8
<i>Elastic cord rings - customised</i> _____	12.4	<i>Cord clips</i> _____	12.8
Rundgummi auf Rolle _____	12.4	Kordeln mit Splinten _____	12.9
<i>Round elastic cords - on reels</i> _____	12.4	<i>Braided cords with hooks</i> _____	12.9
Flachgummi auf Rolle _____	12.5	Lesezeichenband _____	12.9
<i>Flat elastic cords on reel</i> _____	12.5	<i>Page marking ribbon</i> _____	12.9
Fertigschleifen mit Metallsplint _____	12.5	Abschnitte Lesezeichenband und Kordeln nach Kundenwunsch _____	12.9
<i>Cord loops with metal clip</i> _____	12.5	<i>Parts page marking ribbon and cords - customised</i> _____	12.9
Fertigschleifen aus Gummizugschnur _____	12.6	Gummiringe _____	12.10
<i>Elastic cord loops with knot</i> _____	12.6	<i>Rubber bands</i> _____	12.10

Klemmschienen & Posterschienen

Slide binders & poster hanging rail sets

13.

Klemmschienen _____	13.1	Posterklemmschienen _____	13.3
<i>Slide binders</i> _____	13.1	<i>Poster hanging rail sets</i> _____	13.3
Klemmschienen mit Abheftfahne _____	13.1	Posterklemmschienen, aufklappbar _____	13.4
<i>Slide binders with filing strip</i> _____	13.1	<i>Poster hanging rail sets with clamping</i> _____	13.4
Klemmschienen, selbstklebend _____	13.2	Posterklemmschienen Aluminium _____	13.5
<i>Slide Binders, self-adhesive</i> _____	13.2	<i>Slide binders</i> _____	13.5
Klemmschienenhüllen _____	13.2	Posterklemmschienen nach Kundenwunsch _____	13.5
<i>Slide binder covers</i> _____	13.2	<i>Poster hanging rail sets - customised</i> _____	13.5
Klemmschienen nach Kundenwunsch _____	13.2		
<i>Slide binders - customised</i> _____	13.2		

Hüllen für Schutz & Präsentation

Covers for protection & presentation

14.

Prospekthüllen / Ablagehüllen _____	14.1	Umschlaghüllen nach Kundenwunsch _____	14.4
<i>Sheet protectors</i> _____	14.1	<i>Covers for books and documents - customised</i> _____	14.4
Ablagehüllen aus PP-Folie _____	14.1	Hängetaschen _____	14.5
<i>PP foil protective covers</i> _____	14.1	<i>Display pockets</i> _____	14.5
Prospekthüllen nach Kundenwunsch _____	14.2	Drahtbügeltaschen _____	14.5
<i>sheet protectors - customised</i> _____	14.2	<i>Wire framed pockets</i> _____	14.5
Sichthüllen, unbedruckt _____	14.2	Plakattaschen _____	14.6
<i>L-Folders - unprinted</i> _____	14.2	<i>Poster pockets</i> _____	14.6
Sichthüllen, bedruckt _____	14.2	C-Hüllen _____	14.6
<i>L-Folders - printed</i> _____	14.2	<i>C-pckets</i> _____	14.6
Schutzhüllen _____	14.3	Hängetaschen nach Kundenwunsch _____	14.6
<i>Protective covers</i> _____	14.3	<i>Display pockets - customised</i> _____	14.6
Schutzhüllen nach Kundenwunsch _____	14.3	Dokumententaschen _____	14.7
<i>Protective covers - customised</i> _____	14.3	<i>Document folders</i> _____	14.7
Scheckkartenhüllen _____	14.3	Dokumententaschen nach Kundenwunsch _____	14.7
<i>Credit card holders</i> _____	14.3	<i>Document folders - customised</i> _____	14.7
Scheckkartenhüllen nach Kundenwunsch _____	14.4	Kunststoffschlaufe für Gepäckanhänger _____	14.7
<i>Credit card holders - customised</i> _____	14.4	<i>Luggage tags</i> _____	14.7
Umschlaghüllen / Ticketaschen _____	14.4	Magnettaschen _____	14.8
<i>Covers for books and documents</i> _____	14.4	<i>Magnetic pockets</i> _____	14.8



Hüllen für Schutz & Präsentation

Covers for protection & presentation

14.

Ausweishüllen mit farbigem Hängerand _____	14.8	Combi clips _____	14.11
<i>ID pockets with coloured hanging edge</i> _____	14.8	Namensschilder mit Kombiklammer _____	14.11
Ausweishüllen _____	14.9	<i>Name badge holders</i> _____	14.11
<i>ID pockets</i> _____	14.9	Namensschilder mit Magnet _____	14.11
Ausweishüllen nach Kundenwunsch _____	14.9	<i>Magnetic name badge holders</i> _____	14.11
<i>ID pockets - customised</i> _____	14.9	Magnetclip für Namensschilder _____	14.12
Kartenjojo aus Kunststoff _____	14.10	<i>Magnetic catch for badge holders</i> _____	14.12
<i>Badge reel made of plastic</i> _____	14.10	Kaltlaminiertfolien _____	14.12
Hosenträgerclips _____	14.10	<i>Self laminating cards</i> _____	14.12
<i>ID lever clips</i> _____	14.10	Kaltlaminiertfolien nach Kundenwunsch _____	14.12
Lanyard / Schlüsselband _____	14.10	<i>Self laminating cards - customised</i> _____	14.12
<i>Lanyards</i> _____	14.10	Heißlaminiertaschen _____	14.13
Kombiklammern _____	14.11	<i>Hot laminating pouches</i> _____	14.13

Beutel für Versand & Verpackung

Bags for shipping & packaging

15.

Druckverschlussbeutel, PE-Folie 50 µm _____	15.1	Headerbeutel, OPP-Folie 30 µm _____	15.8
<i>Zip lock bags, PE foil, 50 micron</i> _____	15.1	<i>Header bags, OPP foil 30 micron</i> _____	15.8
PE-Klappenbeutel für den Versand _____	15.2	Schlauchfolie _____	15.8
<i>PE bags with flap for mailing</i> _____	15.2	<i>Tubularfoil</i> _____	15.8
Druckverschlussbeutel, PE-Folie 90 µm _____	15.3	PE-Flachbeutel _____	15.9
<i>Zip lock bags, PE foil, 90 micron</i> _____	15.3	<i>PE flat bags</i> _____	15.9
Druckverschlussbeutel, PP-Folie 50 µm _____	15.4	Flachbeutel nach Kundenwunsch _____	15.10
<i>Zip lock bags with hole, PP foil, 50 micron</i> _____	15.4	<i>Flat bags - customised</i> _____	15.10
Dental-Druckverschlussbeutel, PE-Folie 50 µm _____	15.4	Kordelzugbeutel, PE-Folie 50 µm _____	15.10
<i>Dental zip lock bags, PE foil, 50 micron</i> _____	15.4	<i>Drawstring bags, PE foil 50 micron</i> _____	15.10
PP-Klappenbeutel mit Warntext, PP-Folie 40 µm _____	15.4	Schiebeverschlussbeutel _____	15.10
<i>Bags with flap, with warning imprint, PP foil 40 micron</i> _____	15.4	<i>Slide lock bags</i> _____	15.10
PP-Klappenbeutel für den Versand _____	15.5	Begleitpapiertaschen _____	15.11
<i>PP bags with flap for mailing</i> _____	15.5	<i>Packing list envelopes</i> _____	15.11
PP-Flachbeutel, PP-Folie 40 µm _____	15.5	Begleitpapiertaschen nach Kundenwunsch _____	15.11
<i>PP flat bags, PP foil 40 micron</i> _____	15.5	<i>Packing list envelopes - customised</i> _____	15.11
OPP-Klappenbeutel für Glückwunschkarten, OPP-Folie 30 µm _____	15.6	COEX-Klappenbeutel für den Versand _____	15.12
<i>OPP bags with flap for greeting cards, OPP foil 30 micron</i> _____	15.6	<i>COEX bags with flap</i> _____	15.12
Klappenbeutel nach Kundenwunsch _____	15.7		
<i>Bags with flap - customised</i> _____	15.7		

Saugnapfe (Haftsauger)

Suction Cups

16.

Saugnapfe mit Pfeilkopf _____	16.1	Saugnapfe mit M4-Gewinde _____	16.2
<i>Suction cups with arrow head</i> _____	16.1	<i>Suction cups with screw top (M4)</i> _____	16.2
Saugnapfe mit Kopf _____	16.1	Saugnapfe mit Kartenhalter _____	16.3
<i>Suction cups with mushroom head</i> _____	16.1	<i>Suction cups with card holder</i> _____	16.3
Saugnapfe mit Dorn zum Einstecken _____	16.1	Weitere Saugnapfe _____	16.3
<i>Suction cups with thumb tack</i> _____	16.1	<i>More suction cups</i> _____	16.3
Saugnapfe mit Metallhaken _____	16.2		
<i>Suction cups with metal hook</i> _____	16.2		



Weiterer Druckerei- & Werbebedarf

Further printing accessories

17.

Foldback-Klammern _____	17.1	Stifthalter _____	17.6
<i>Fold back clips</i> _____	17.1	<i>Pen-holders</i> _____	17.6
Best Price Fälzelband _____	17.1	PVC-Ringbücher _____	17.7
<i>Best Price spine tape</i> _____	17.1	<i>Ring binders</i> _____	17.7
Fälzelband REGUtex R _____	17.2	PVC-Schnellhefter nach Kundenwunsch _____	17.7
<i>Spine tape REGUtex R</i> _____	17.2	<i>File folders - customised</i> _____	17.7
Fälzelband REGUdux RX _____	17.2	Register für DIN A4 _____	17.8
<i>Spine Tape REGUdux RX</i> _____	17.2	<i>Index systems for A4</i> _____	17.8
Fälzelband REGUtaf H3 _____	17.3	Register nach Kundenwunsch _____	17.8
<i>Spine tape REGUtaf H3</i> _____	17.3	<i>Index systems - customised</i> _____	17.8
Selbstklebende Abheftstreifen _____	17.3	Papierbohrer _____	17.9
<i>Self-adhesive filing strips</i> _____	17.3	<i>Paper drill bits</i> _____	17.9
Selbstklebende Abheftstreifen nach Kundenwunsch _____	17.4	Wachspapierstreifen für Papierbohrer _____	17.10
<i>Self-adhesive filing strips - customised</i> _____	17.4	<i>Waxed paper stripes for paper drill bits</i> _____	17.10
Elastikpuffer _____	17.4	Bohrpappe _____	17.10
<i>Bumpers</i> _____	17.4	<i>Drilling cardboard</i> _____	17.10
Visitenkartenhalter _____	17.5	Falzbeine _____	17.10
<i>Business card holders</i> _____	17.5	<i>Folding tool</i> _____	17.10
Visitenkartenboxen _____	17.5	Zeilenmaß (Typometer) _____	17.11
<i>Business card boxes</i> _____	17.5	<i>Line gauge</i> _____	17.11
Spielkartenschachteln _____	17.5		
<i>Playing card boxes</i> _____	17.5		

Werbetechnik

Advertising and promo items

18.

Gehwegaufsteller, DIN A1 _____	18.1	Klapprahmen _____	18.2
<i>Pavement board for A1</i> _____	18.1	<i>Snap frame</i> _____	18.2
Deckblätter DIN A1 _____	18.1	Magnetrahmen mit Magnetband _____	18.2
<i>Binding covers A1</i> _____	18.1	<i>Magnetic frames with magnetic tape</i> _____	18.2



Versand & Weitere Informationen Delivery & Further Information



Delivery & further information

Shipping to Germany

250 € and up - free of charge
up to 250 € - 5.50 € shipping

Shipping to Austria / Benelux Union

500 € and up - free of charge

Shipping to Europe

see <http://shipping.sprintis.eu>

Shipping worldwide

on request

Express-shipping to Germany

next day 8:30 a.m. - 39.00 € per 20 kg
next day 10:30 a.m. - 25.00 € per 20 kg
next day 12 p.m. - 18.00 € per 20 kg
same day service - on request
delivery on saturday - on request

Express-shipping to Europe

on request

Delivery to third parties

We can ship goods with your delivery note directly to your customers.

Packaging

free of charge

Terms of payment Germany / Austria / Switzerland / Benelux

SEPA Direct Debit with 2% discount
invoice with 30 days / net
credit-card

pre-payment
PayPal
Sofortüberweisung

Terms of payment worldwide

pre-payment
credit-card
other payment terms on request

Free samples

We can send samples of almost all our products free of charge.

Versand & weitere Informationen

Standard-Versand deutschlandweit

ab 250 € - frei Haus
unter 250 € - 5,50 € Versandpauschale

Standard-Versand AT / Benelux

ab 500 € - frei Haus

Standard-Versand europaweit

siehe <http://versand.sprintis.de>

Standard-Versand weltweit

Fragen Sie uns!

Express-Versand deutschlandweit

bis 8:30 Uhr am nächsten Werktag - 39,00 € pro 20 kg
bis 10:30 Uhr am nächsten Werktag - 25,00 € pro 20 kg
bis 12:00 Uhr am nächsten Werktag - 18,00 € pro 20 kg
Kurierfahrten (same day) - auf Anfrage
Samstagszustellung - auf Anfrage

Express-Versand europaweit

Fragen Sie uns!

Neutraler Versand

Auf Wunsch verschicken wir die Ware neutral an eine dritte Adresse.
Kundenschutz ist garantiert.

Verpackung

kostenfrei

Zahlungsbedingungen D / AT / CH / Benelux

SEPA Basislastschrift mit 2% Skonto
auf Rechnung 30 Tagen / netto
Kreditkarte

Vorauskasse
PayPal
Sofortüberweisung

Zahlungsbedingungen Europa / Welt

Vorauskasse
Kreditkarte
Abweichende Zahlungsbedingungen auf Anfrage

Kostenlose Mustersendungen

Nahezu alle Artikel versenden wir Ihnen als kostenfreie Muster.

SPRINTIS Newsletter

Immer auf dem Laufenden: <http://newsletter.sprintis.de>

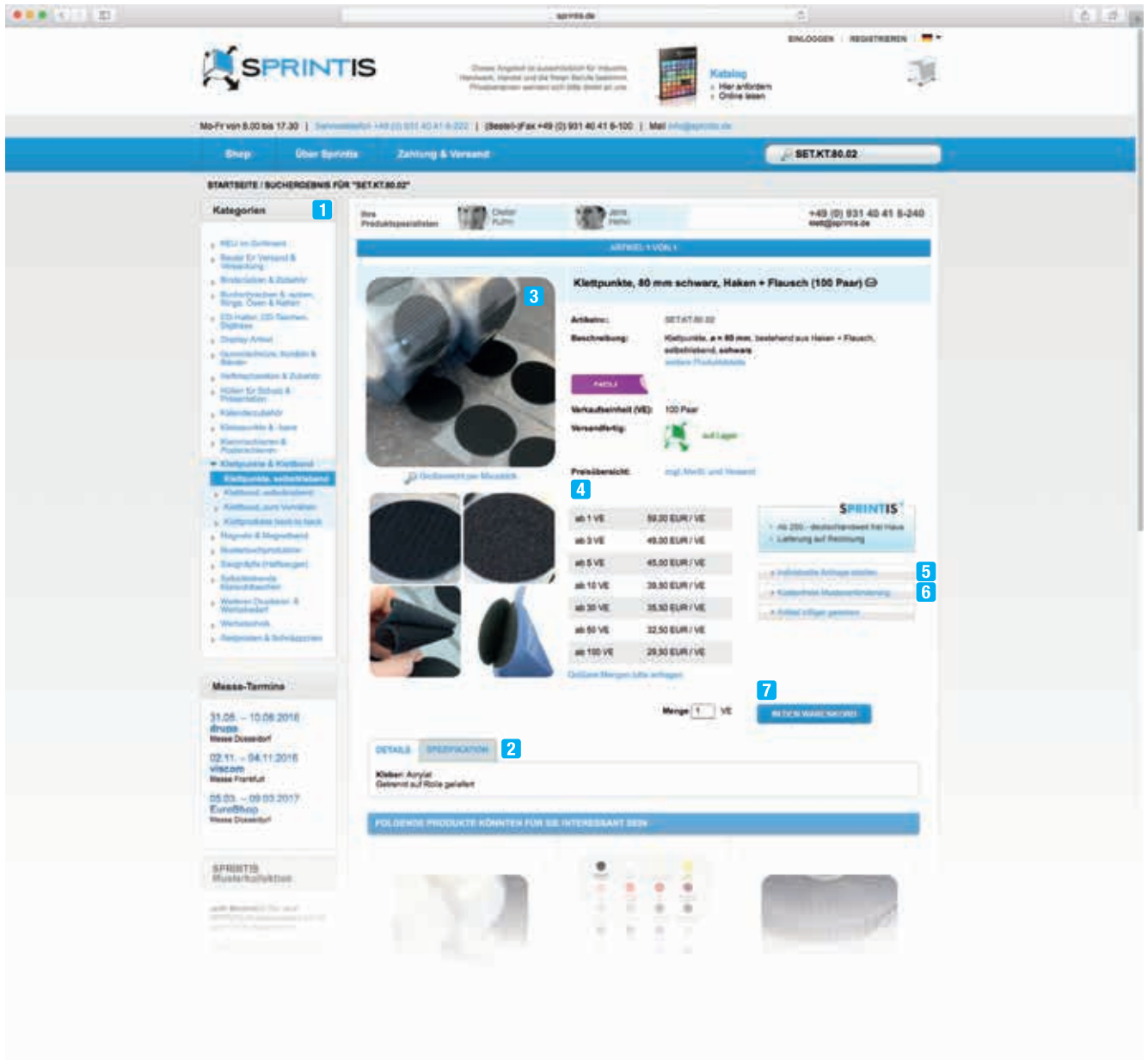

SPRINTIS on the web

We'd also like to welcome you to our website where you can find current prices as well as detailed descriptions:

- 1** More than 3,000 products are logically sorted into different categories.
- 2** You'll find detailed descriptions of every product.
- 3** There's an instructive picture of every product.
- 4** An overview of prices for every product speeds up your calculation.
- 5** Start your individual request for larger quantities with only one click.
- 6** Free delivery of samples for almost every in-stock product.
- 7** Your shopping basket: buy comfortably in our online shop.

SPRINTIS im Internet

Gerne begrüßen wir Sie auch im Internet. Dort stehen Ihnen aktuelle Preise zur Verfügung und ebenso umfangreiche wie schnelle Recherchemöglichkeiten:

- 1** Über 3.000 Artikel sind in den verschiedenen Kategorien logisch sortiert.
- 2** Ausführliche Produktbeschreibungen finden Sie zu jedem Artikel.
- 3** Zu jedem Produkt gibt es eine aufschlussreiche Produktabbildung.
- 4** Eine Preisübersicht beschleunigt das Kalkulieren.
- 5** Starten Sie Ihre individuelle Anfrage für größere Mengen mit nur einem Knopfdruck.
- 6** Wir senden Ihnen gerne kostenfreie Muster von allen Lagerartikeln.
- 7** Ihr Warenkorb: bequem einkaufen direkt im Online-Shop.



Heftmechaniken & Zubehör
File prongs & accessories

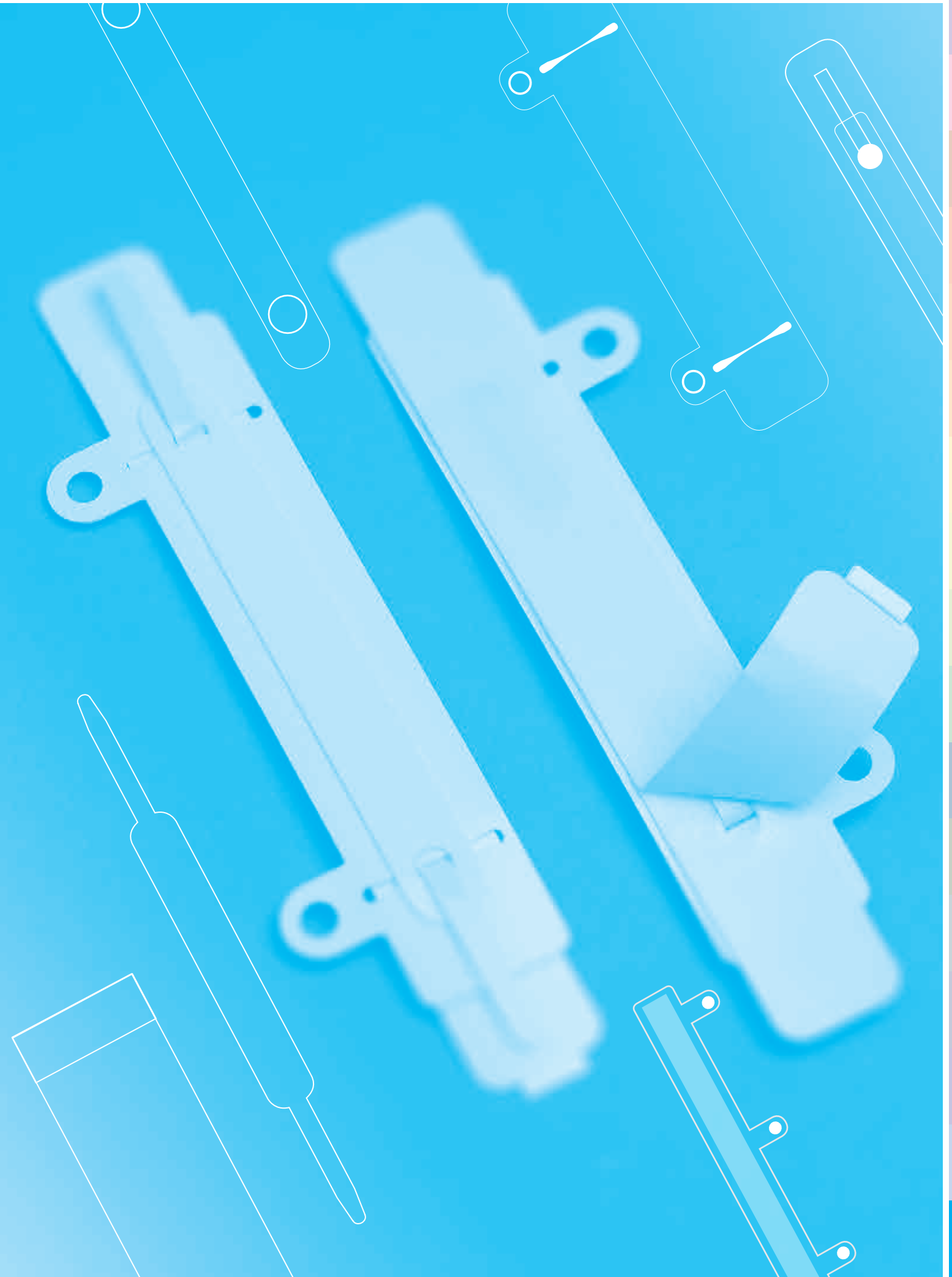



Heftmechaniken & Zubehör

File prongs & accessories

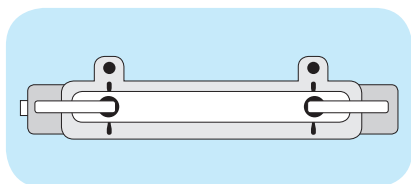

Heftmechaniken mit Abheftvorrichtung

File prongs with additional file systems

komplett montiert, selbstklebend, 4-teilig

fully assembled, self-adhesive, 4 parts

Artikel-Nr. Item no.	Format Size	Farbe Colour
SM.MA.150016.01	150 x 16 mm	<input type="checkbox"/> weiß white
SM.MA.150020.01 ¹	150 x 20 mm	<input type="checkbox"/> weiß white
SM.MA.150020.02	150 x 20 mm	<input checked="" type="checkbox"/> schwarz black

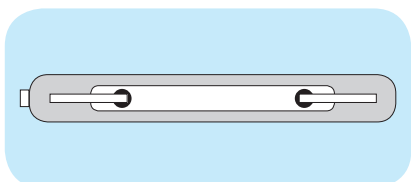

Heftmechaniken ohne Abheftvorrichtung

File prongs without file system

komplett montiert, selbstklebend, 3-teilig

fully assembled, self-adhesive, 3 parts

Artikel-Nr. Item no.	Format Size	Farbe Colour
SM.OA.105020.01	105 x 20 mm	<input type="checkbox"/> weiß white
SM.OA.150016.01	150 x 16 mm	<input type="checkbox"/> weiß white
SM.OA.150020.01 ¹	150 x 20 mm	<input type="checkbox"/> weiß white
SM.OA.150020.02	150 x 20 mm	<input checked="" type="checkbox"/> schwarz black



Abdeckschienen für Heftmechaniken

Cover strips for file prongs

297 mm lang

length 297 mm

Artikel-Nr. Item no.	Farbe Colour
SM.AS.297.01 ¹	<input type="checkbox"/> weiß white

Außerdem im Angebot | Also available

Abdeckschienen in Sonderformaten und Sonderfarben ab 5.000 Stück.

Request various colours and sizes on orders over 5,000 pieces.



Heftmechaniken & Zubehör

File prongs & accessories

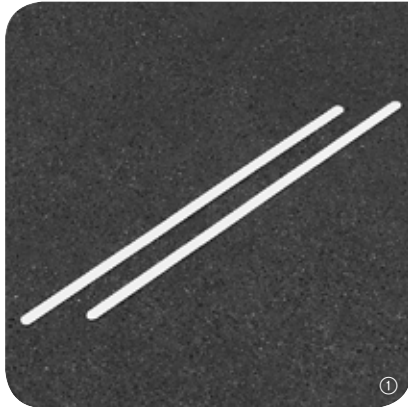

Heftzungen

File prongs

Artikel-Nr. Item no.	Format Size	Ausführung Description
NEU SM.SZ.148.WL.01	148 x 4,5 mm	weiß lackiert white painted
SM.SZ.160.KU.01	160 x 4 mm	weiß kunststoffummantelt plastic coated white
SM.SZ.160.15 ²	160 x 4 mm	messingfarben brass-plated
SM.SZ.165.KU.EK.01 ³	160 x 4 mm	weiß kunststoffummantelt mit Endkappen plastic coated white with end caps
SM.SZ.165.WL.01 ¹	165 x 4 mm	weiß lackiert white painted

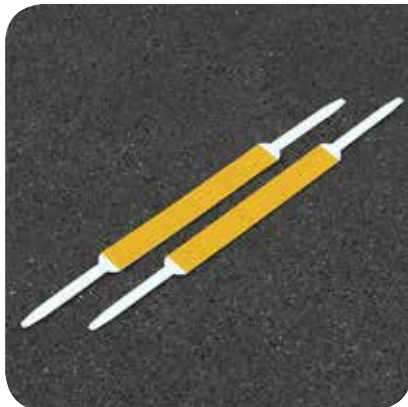
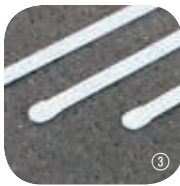

Heftzungen, selbstklebend

File prongs, self-adhesive

weiß lackiert
white painted

Artikel-Nr. Item no.	Format Size
SM.SZ.150.SK.01	150 mm



Doppelspiralfeder

Double spiral spring

auf Grundplatte 90 x 12 mm befestigt, 60 mm Federlänge, vernickelt
on base plate 90 x 12 mm mounted, 60 mm spiral length, nickel-plated

Artikel-Nr. Item no.	Format Size
SM.DSF.60.06	60 mm Federlänge 60 mm spiral length

NEU
now in stock

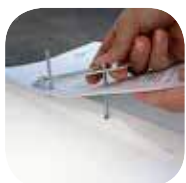



Abheftvorrichtungen mit 2 Ösen

Plastic fasteners with 2 eyelets

Hart-PVC, 122 mm lang

rigid-PVC, length 122 mm

Artikel-Nr. Item no.	Ausführung Description	Farbe Colour	Folienstärke Foil thickness
SM.AV.GS.00 ⁴	geschlitzt slotted	☐ transparent transparent	400 µm 400 micron
SM.AV.GS.01 ¹	geschlitzt slotted	☐ weiß white	400 µm 400 micron
SM.AV.SK.00	selbstklebend self-adhesive	☐ transparent transparent	400 µm 400 micron
SM.AV.SK.01 ³	selbstklebend self-adhesive	☐ weiß white	400 µm 400 micron
SM.AV.UG.00	ungeschlitzt not slotted	☐ transparent transparent	400 µm 400 micron
SM.AV.HR.HPVC050.00 ²	halbrund semicircular	☐ transparent transparent	500 µm 500 micron

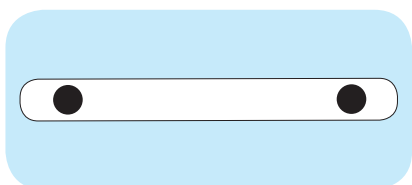
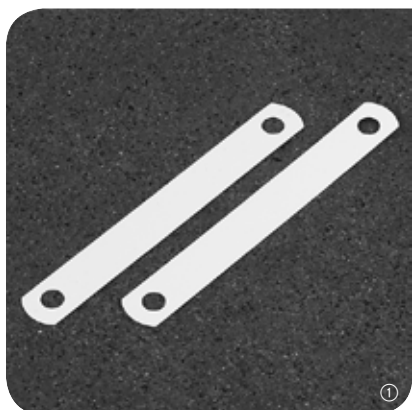

Kunststoffdeckleisten

Plastic compressor bars

Hart-PVC, weiß, 80 mm Lochung

rigid-PVC, white, perforation pitch 80 mm

Artikel-Nr. Item no.	Format Size	Folienstärke Foil thickness
SM.KD.095012.01 ¹	95 x 12 mm	350 µm 350 micron
SM.KD.120012.01	120 x 12 mm	350 µm 350 micron



NEU
now in stock



Hakendeckleiste

Hook compressor bars

2-fach gelocht (80 mm), vernickelt
perforation 2-on-1 (80 mm), nickel-plated

Artikel-Nr. Item no.	Format Size
SM.HD.140017.06	140 x 17 mm



Abheftvorrichtungen mit 4 Ösen

Plastic fasteners with 4 eyelets

Hart-PVC, 280 mm lang
rigid-PVC, length 280 mm

Artikel-Nr. Item no.	Ausführung Description	Farbe Colour	Folienstärke Foil thickness
SM.AV.40E.00	Standard standard	☐ transparent transparent	400 µm 400 micron
SM.AV.40E.01 ¹	Standard standard	☐ weiß white	400 µm 400 micron
SM.AV.40E.02	Standard standard	■ schwarz black	400 µm 400 micron
SM.AV.40E.SK.00	selbstklebend self-adhesive	☐ transparent transparent	400 µm 400 micron
SM.AV.40E.SK.01 ³	selbstklebend self-adhesive	☐ weiß white	400 µm 400 micron
SM.AV.40E.SK.02 ²	selbstklebend self-adhesive	■ schwarz black	400 µm 400 micron



Rechtecktaschen für Abheftvorrichtungen

Pockets for plastic fasteners with 2 eyelets

selbstklebend, Weich-PVC 150 µm transparent
self-adhesive, soft-PVC 150 micron, transparent

Artikel-Nr. Item no.	Format Size	Ausführung Description
SM.AV.125040.SK.WPVC014	125 x 40 mm	passend für eine Abheftvorrichtung zum Ausschleiben suitable for fasteners with 2 eyelets

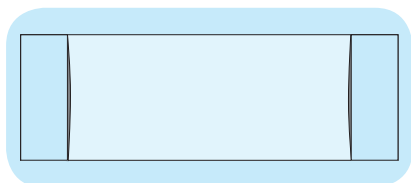



Heftmechaniken & Zubehör

File prongs & accessories



Heftverschlüsse mit Schieberdeckleiste

Metal file fittings

zweiteilig, vernickelt, 50 mm Füllhöhe
2 parts, nickel-plated, 50 mm filling level

Artikel-Nr. | Item no. **Ausführung | Description**

SM.HV.SD.06 für 80 mm Lochung | for 80 mm perforation pitch

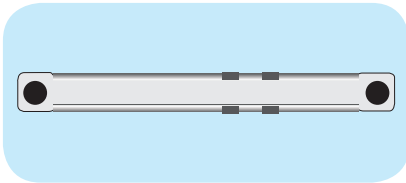

Schlauchmechaniken

Tube mechanics

NEU
now in stock

3-teilig, weiß / grau
3-parts, white / grey

Artikel-Nr. | Item no. **Ausführung | Description**

SET.SM.SLM.215.01_11 215 mm Schlauch | 215 mm tube



Archivclips

Archive clips

NEU
now in stock

2-teilig, weiß
2-parts, white

Artikel-Nr. | Item no. **Ausführung | Description**

Füllhöhe | Filling level

SM.AC.85.01 Abheftbügel und Deckleiste | file frame and compressor bar bis 85 mm | up to 85 mm





Selbstklebende Klarsichttaschen

Self-adhesive pockets





Selbstklebende Klarsichttaschen

Self-adhesive pockets

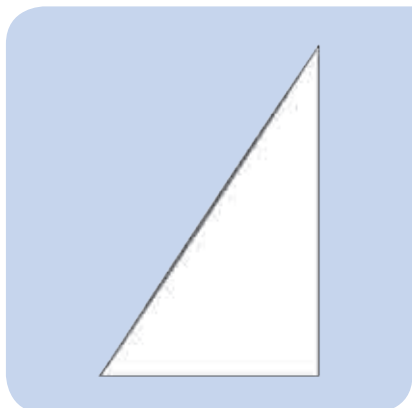

Dreiecktaschen, ungleichschenkelig

Corner pockets, unequal-sided

selbstklebend, PP-Folie 120 µm, transparent

self-adhesive, PP foil 120 micron, transparent

Artikel-Nr. Item no.	Format Size	Ausführung Description
DT.100150.R	100 x 150 mm	langer Schenkel rechts long edge right
DT.140210.R ¹	140 x 210 mm	langer Schenkel rechts long edge right
DT.150100.L	150 x 100 mm	langer Schenkel links long edge left
DT.210140.L ²	210 x 140 mm	langer Schenkel links long edge left

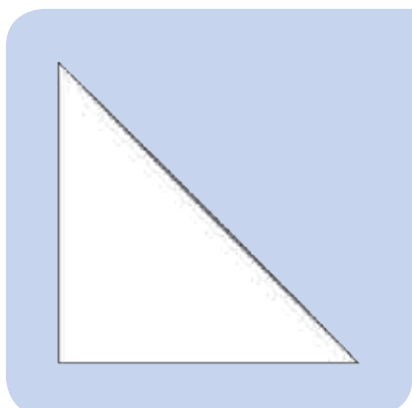

Dreiecktaschen, gleichschenkelig

Corner pockets, isosceles triangular

selbstklebend, PP-Folie 120 µm, transparent

self-adhesive, PP foil 120 micron, transparent

Artikel-Nr. Item no.	Format Size
DT.032032	32 x 32 mm
DT.050050	50 x 50 mm
DT.070070	70 x 70 mm
DT.100100	100 x 100 mm
DT.120120	120 x 120 mm
DT.140140	140 x 140 mm
DT.150150	150 x 150 mm
DT.170170 ¹	170 x 170 mm
DT.200200	200 x 200 mm
DT.210210	210 x 210 mm

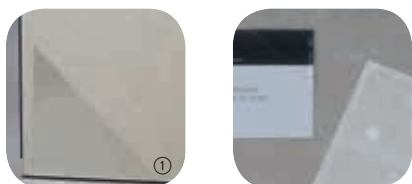

selbstklebend, Weich-PVC 150 µm, transparent, max. Füllhöhe bis 10 mm

self-adhesive, soft-PVC 150 micron, transparent, max. filling level of 10 mm

Artikel-Nr. Item no.	Format Size
DT.140140.FH10.WPVC015	140 x 140 mm



Selbstklebende Klarsichttaschen

Self-adhesive pockets

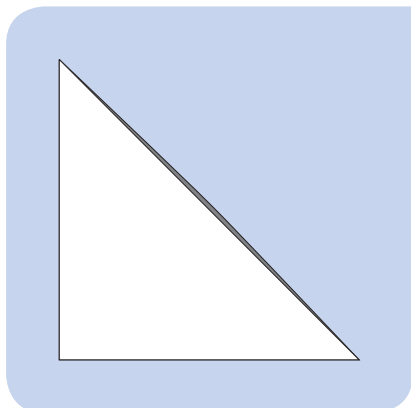

Dreiecktaschen aus Papier

Corner pockets, paper

selbstklebend, 80 g / m² Kraftpapier weiß (ca. 5-8 mm Rand beachten)

self-adhesive, 80g / m² white paper, please note a 5-8 mm margin

Artikel-Nr. | Item no. Format | Size

DT.PAPIER.140140 140 x 140 mm

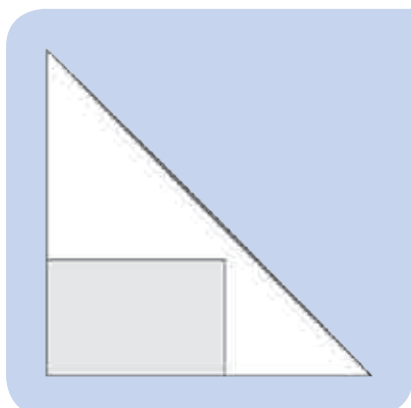

Dreiecktaschen mit aufgeschweißter Visitenkartentasche

Corner pockets with welded-on pocket for business cards

selbstklebend, transparent

self-adhesive, transparent

Artikel-Nr. | Item no. Format | Size Ausführung | Description

DT.150150.VK.094056.L¹ 150 x 150 mm mit Visitenkartentasche 94 x 56 mm (Breit- und Schmalseite offen), für die linke Seite
for the left side, with pocket for business card (94 x 56 mm, two edges open)

DT.150150.VK.094056.R² 150 x 150 mm mit Visitenkartentasche 94 x 56 mm (Breit- und Schmalseite offen), für die rechte Seite
for the right side, with pocket for business card (94 x 56 mm, two edges open)

DT.170170.VK.100060.PP.L 170 x 170 mm mit Visitenkartentasche 100 x 60 mm (Breitseite offen), für die linke Seite
for the left side, with pocket for business card (100 x 60 mm, open to the top)

DT.170170.VK.100060.PP.R 170 x 170 mm mit Visitenkartentasche 100 x 60 mm (Breitseite offen), für die rechte Seite
for the right side, with pocket for business card (100 x 60 mm, open to the top)





Dreiecktaschen nach Kundenwunsch

Corner pockets - customised

 Mindestmenge: 250 Stück
minimum quantity: 250 pieces

 Sonderformate und Sonderformen in jeder gewünschten Abmessung und Form,
egal ob gleichschenkelig oder ungleichschenkelig
available in almost every desired size, short edge open or long edge open

 verschiedene Folienarten, Folienstärken und Folienfarben, z.B. glasklar, matt, transluzent oder farbig
different foil types, thicknesses and colours, e.g. transparent, frosted, translucent or coloured

 Aufdruck im Siebdruck, Offsetdruck oder mit (Blind)-Prägung
overprint by silk screen printing, offset printing or (blind) embossing

 aus Karton oder Papier
made of cardboard or paper

 mit aufgeschweißter Tasche, für Visitenkarten
with welded-on pocket, e.g. for business cards



Selbstklebende Klarsichttaschen

Self-adhesive pockets

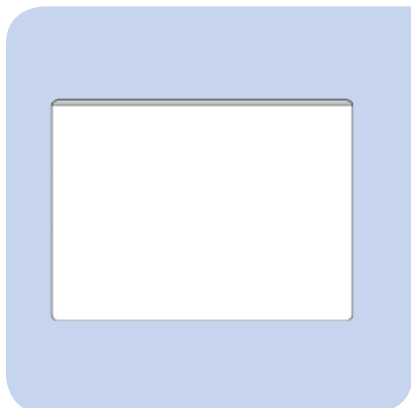

Rechtecktaschen

Rectangular pockets

selbstklebend, PP-Folie 120 µm, transparent
self-adhesive, PP foil 120 micron, transparent

Artikel-Nr. Item no.	Format Size	Ausführung Description
RT.052060.KL.KP	52 x 60 mm	mit Klappe und Klebepunkt, z.B. für Speicherkarten, Schmalseite offen <i>with flap and adhesive dot, e.g. for memory cards, short edge open</i>
RT.052092.KL.KP	52 x 92 mm	mit Klappe und Klebepunkt, z.B. für USB-Sticks, Schmalseite offen <i>with flap and adhesive dot, e.g. for USB flash drives, short edge open</i>
RT.060060.PP012	60 x 60/55 mm	eine Seite offen, Vorderfolie um 5 mm verkürzt <i>one edge open, shortened front foil by 5 mm</i>
RT.DINLANG.BS.PP012	für Inhalt DIN-lang for DL	Breitseite offen <i>long edge open</i>
RT.A7.SS.PP012	für Inhalt DIN A7 for A7	Schmalseite offen <i>short edge open</i>
RT.A7.BS.PP012 ²	für Inhalt DIN A7 for A7	Breitseite offen <i>long edge open</i>
RT.A6.SS.PP012	für Inhalt DIN A6 for A6	Schmalseite offen <i>short edge open</i>
RT.A6.BS.PP012 ¹	für Inhalt DIN A6 for A6	Breitseite offen <i>long edge open</i>
RT.109100.KL.KP ⁴	109 x 100 mm	mit Klappe und Klebepunkt, 2 Fächer <i>with flap and adhesive dot, 2 pockets</i>
RT.110065.AG.BS	110 x 65/45 mm	abgeschrägt, Breitseite offen <i>slanted, long edge open</i>
RT.A5.BS.KL.KP.PP012 ⁵	für Inhalt DIN A5 for A5	mit Klappe und Klebepunkt, Breitseite offen <i>with flap and adhesive dot, long edge open</i>
RT.A5.SS.PP012	für Inhalt DIN A5 for A5	Schmalseite offen <i>short edge open</i>
RT.A5.BS.PP012	für Inhalt DIN A5 for A5	Breitseite offen <i>long edge open</i>
RT.155090.AG.BS	155 x 90/65 mm	abgeschrägt, Breitseite offen <i>slanted, long edge open</i>
RT.A4.BS.KL.KP.PP012	für Inhalt DIN A4 for A4	mit Klappe und Klebepunkt, Breitseite offen <i>with flap and adhesive dot, long edge open</i>
RT.A4.SS.PP012 ³	für Inhalt DIN A4 for A4	Schmalseite offen <i>short edge open</i>
RT.A4.BS.PP012	für Inhalt DIN A4 for A4	Breitseite offen <i>long edge open</i>
RT.217130.AG.BS	217 x 130/95 mm	abgeschrägt, Breitseite offen <i>slanted, long edge open</i>
RT.A3.SS.PP012	für Inhalt DIN A3 for A3	Schmalseite offen <i>short edge open</i>
RT.A3.BS.PP012	für Inhalt DIN A3 for A3	Breitseite offen <i>long edge open</i>

selbstklebend, Weich-PVC 150 µm, transparent, max. Füllhöhe bis 10 mm
self-adhesive, soft-PVC 150 micron, transparent, max. filling level of 10 mm

Artikel-Nr. Item no.	Format Size	Ausführung Description
RT.A5.BS.FH10.WPVC015.028	für Inhalt DIN A5 for A5	Breitseite offen <i>long edge open</i>

selbstklebend, Hart-PVC 140 µm, transparent
self-adhesive, rigid-PVC 140 micron, transparent

Artikel-Nr. Item no.	Format Size	Ausführung Description
RT.A5.QLA.HPVC014	für Inhalt DIN A5 for A5	Breit- und Schmalseite offen, Vorderfolie um 5 mm, mit Einschubdreieck (Quickload) <i>long and short edge open, shortened front foil by 5 mm, with insertion corner (Quickload)</i>
RT.A4.QLA.HPVC014 ⁶	für Inhalt DIN A4 for A4	Breit- und Schmalseite offen, Vorderfolie um 5 mm, mit Einschubdreieck (Quickload) <i>long and short edge open, shortened front foil by 5 mm, with insertion corner (Quickload)</i>



Selbstklebende Klarsichttaschen

Self-adhesive pockets

Visitenkartentaschen

Business card pockets

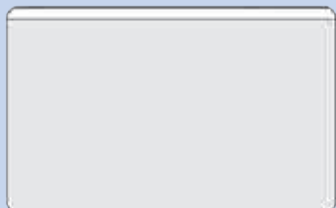

selbstklebend, PP-Folie 120 µm, transparent

self-adhesive, PP foil 120 micron, transparent

Artikel-Nr. Item no.	Format Size	Ausführung Description	Material Material
VK.060095.SS.DA ³	60 x 95 mm	Schmalseite offen, mit Daumenausstanzung short edge open, cut-out for thumb	PP-Folie 120 µm PP foil 120 micron
VK.095060.BS ¹	95 x 60 mm	Breitseite offen, Vorderfolie verkürzt long edge open, front foil shortened	PP-Folie 120 µm PP foil 120 micron
VK.095060.BS.DA.OBEN	95 x 60 mm	mit Daumenausstanzung oben an der offenen Breitseite cut-out for thumb on the open long edge	PP-Folie 120 µm PP foil 120 micron
VK.095060.BS.DA	95 x 60 mm	Breitseite offen, mit Daumenausstanzung an der geschlossenen Seite long edge open, cut-out for thumb on the closed long edge	PP-Folie 120 µm PP foil 120 micron
VK.105060.BS	105 x 60 mm	Breitseite offen, Vorderfolie verkürzt long edge open, front foil shortened	PP-Folie 120 µm PP foil 120 micron
VK.105060.BS.KL.KP ²	105 x 60 mm	mit Klappe und Klebepunkt, Breitseite offen, Vorderfolie verkürzt with flap and adhesive dot, long edge open, front foil shortened	PP-Folie 120 µm PP foil 120 micron
VK.110060.BS	110 x 60 mm	Breitseite offen, Vorderfolie verkürzt long edge open, front foil shortened	PP-Folie 120 µm PP foil 120 micron
VK.115072.BS	115 x 72 mm	Breitseite offen, Vorderfolie verkürzt long edge open, front foil shortened	PP-Folie 120 µm PP foil 120 micron
VK.190060.2T.BS	190 x 60 mm	Doppelvisitenkartentaschen, 2 Taschen je ca. 95 x 60 mm nebeneinander, Breitseite offen, Vorderfolie verkürzt Double business card pockets, separated into 2 pockets, approx size each 95 x 60 mm, long edge open, front foil shortened	Weich-PVC 150 µm soft-PVC 150 micron

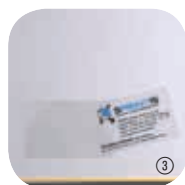

Rückenschildtaschen

Spine label pockets

selbstklebend, PP-Folie 120 µm, transparent, Schmalseite offen, mit Daumenausparung

self-adhesive, PP foil 120 micron, transparent, short edge open, with cut-out for thumb

Artikel-Nr. Item no.	Format Size
RT.019075.SS.DA	19 x 75 mm
RT.025075.SS.DA ¹	25 x 75 mm
RT.035075.SS.DA	35 x 75 mm
RT.035102.SS.DA	35 x 102 mm
RT.046075.SS.DA	46 x 75 mm
RT.055102.SS.DA	55 x 102 mm

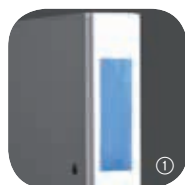
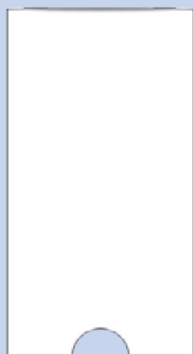





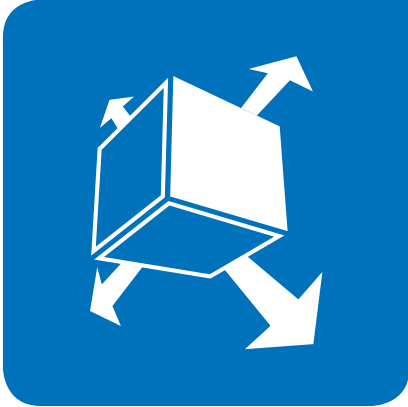





Selbstklebende Klarsichttaschen Self-adhesive pockets



Visitenkartentaschen / Rechtecktaschen nach Kundenwunsch Business card and rectangular pockets – customised

-  Mindestmenge: 250 Stück
minimum quantity: 250 pieces
-  Sonderformate in fast jeder gewünschten Abmessung, egal ob Schmalseite oder Breitseite offen
available in almost every desired size, short edge or long edge open
-  mit Füllhöhe als Froschtasche oder Hohlgeschweißtasche
with filling level
-  mit Daumenausparung oder Einreißschutz
with cut-out for thumb or tear protection
-  Abschweißungen für mehrere Taschen
welded for multi-pockets
-  mit aufgeschweißter Tasche, z.B. für Visitenkarten
with welded-on pocket, e.g. for business cards
-  verschiedene Folienarten, Folienstärken und Folienfarben, z.B. glasklar, matt, transluzent oder farbig
different foil types, thicknesses and colours, e.g. transparent, frosted, translucent or coloured
-  große Stückzahlen aus PP-Folie (ohne Weichmacher, dokumentenecht)
large amounts made from PP foil (without softener, indelible)
-  Aufdruck im Siebdruck, Offsetdruck oder mit (Blind)-Prägung
overprint with silk screen printing, offset printing or with (blind) embossing



CD-Halter & CD-Taschen, Digitrays

CD / DVD storage and mounting

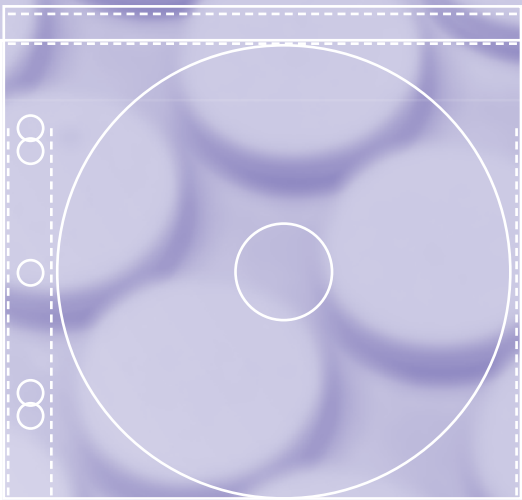
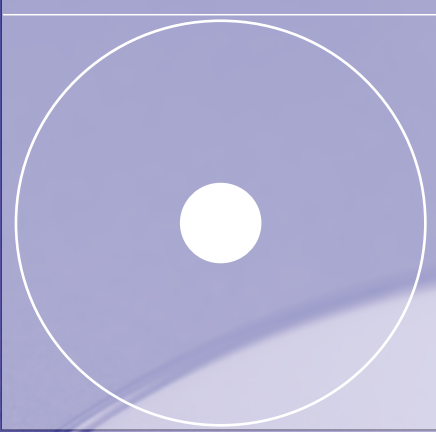



CD-Halter & CD-Taschen, Digitrays CD / DVD storage and mounting



CD-Halter aus Schaumstoff

CD foam studs

selbstklebend, 16 mm Durchmesser, ca. 3,5 mm dick
self-adhesive, 16 mm diameter, thickness approx. 3.5 mm

Artikel-Nr. | Item no. Farbe | Colour

CD.16.01² weiß | white

CD.16.02¹ schwarz | black

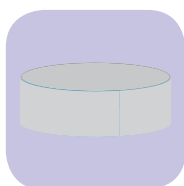

CD-Clips

CD holders

selbstklebend, Kunststoff
self-adhesive, made of plastic

Artikel-Nr. | Item no. Durchmesser | Diameter Farbe | Colour

CD.35.00 35 mm transparent | transparent

CD.35.01² 35 mm weiß | white

CD.35.02¹ 35 mm schwarz | black





CD-Halter & CD-Taschen, Digtirays

CD / DVD storage and mounting



CD-Taschen

CD pockets

selbstklebend, transparent

self-adhesive, transparent

Artikel-Nr. Item no.	Format Size	Ausführung Description
CD.091091.SK.KL ¹	91 x 91 mm	unten eckig, passend für 1 Mini-CD, mit Klappe zum Einstecken <i>suitable for 1 Mini-CD, with inserted flap, squared</i>
CD.095090.SK	95 x 90 mm	unten eckig, passend für 1 Mini-CD, ohne Klappe, Breitseite offen <i>suitable for 1 Mini-CD, without flap, long edge open, squared</i>
CD.126125.SK ²	126 x 125 mm	unten eckig, ohne Klappe squared without flap
CD.126126.R.SK ³	126 x 126 mm	unten rund, ohne Klappe round, without flap
CD.126126.SK.KL.KP ⁴	126 x 126 mm	unten rund, mit Klappe und Klebepunkt round, with flap and adhesive dot
CD.126126.SK.KL.KP.ECK ⁵	126 x 126 mm	unten eckig, mit Klappe und Klebepunkt squared, with flap and adhesive dot
CD.129130.SK.KL ⁶	129 x 130 mm	unten eckig, mit Klappe zum Einstecken, Eingriff und Einreißschutz <i>with inserted flap, slot and tear protection</i>





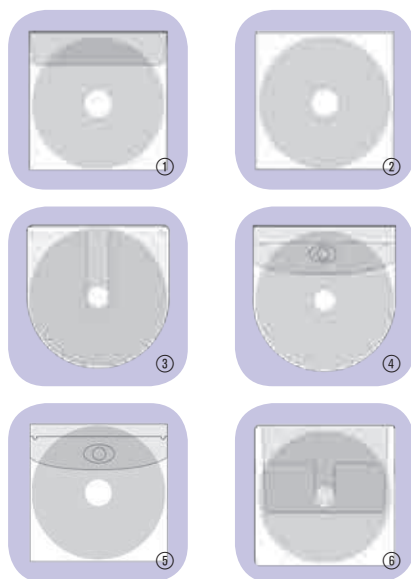

Außerdem im Angebot | Also available

CD.129130.KL	CD-Hülle 129 x 130 mm, unten eckig, nicht selbstklebend, mit Klappe <i>CD cover, 129 x 130 mm, not adhesive, with flap, squared</i>
--------------	--



CD-Taschen nach Kundenwunsch

CD pockets – customised

-  Mindestmenge: 250 Stück
minimum quantity: 250 pieces
-  Sonderformate und Sonderformen in jeder gewünschten Abmessung
all formats available in nearly all desired dimensions
-  mit Füllhöhe als Froschtasche oder Hohlschweißtasche (z.B. für eine Jewelbox)
with filling level
-  Abschweißungen für mehrere Taschen
welding for multi-pockets
-  Aufdruck im Siebdruck, Offsetdruck oder mit (Blind)-Prägung
overprint with silk screen printing, offset printing or with (blind) embossing
-  mit aufgeschweißter Tasche, z.B. für Visitenkarten
with welded-on pocket, e.g. for business cards



CD-Halter & CD-Taschen, Digitrays

CD / DVD storage and mounting



CD-Ablagehüllen

CD filing pockets

transparent, Abheftrand mit Lochung

transparent, with punched filing strip

Artikel-Nr. Item no.	Format Size	Ausführung Description
CD.AL.1CD ¹	144 x 136 mm	mit Klappe für 1 CD, Abheftrand mit 5-fach Lochung <i>with flap and 5-on-1 hole, suitable for one CD</i>
CD.AL.2CD ²	228 x 286 mm	für 2 CDs, Abheftrand mit Lochung 11-fach Lochung <i>with 11-on-1 hole, suitable for two CDs</i>



CD-Trays

Digitrays

Polystyrol

made of polystyrol

Artikel-Nr. Item no.	Format Size	Farbe Colour
CD.TRAY.DVD.00	135 x 186 x 4,7 mm	☐ transparent <i>transparent</i>
CD.TRAY.DVD.01 ²	135 x 186 x 4,7 mm	☐ weiß glänzend <i>white glossy</i>
CD.TRAY.DVD.02	135 x 186 x 4,7 mm	■ schwarz glänzend <i>black glossy</i>
CD.TRAY.AUDIO.00	137 x 124 x 4,2 mm	☐ transparent <i>transparent</i>
CD.TRAY.AUDIO.01 ¹	137 x 124 x 4,2 mm	☐ weiß glänzend <i>white glossy</i>
CD.TRAY.AUDIO.02	137 x 124 x 4,2 mm	■ schwarz glänzend <i>black glossy</i>

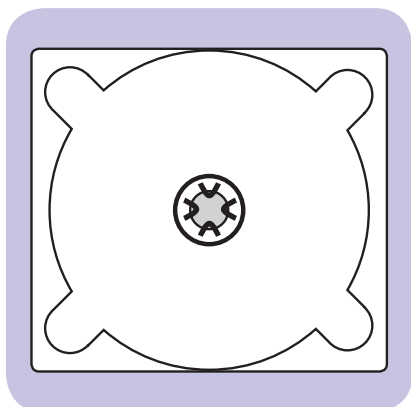



Kalenderzubehör

Calendar accessories

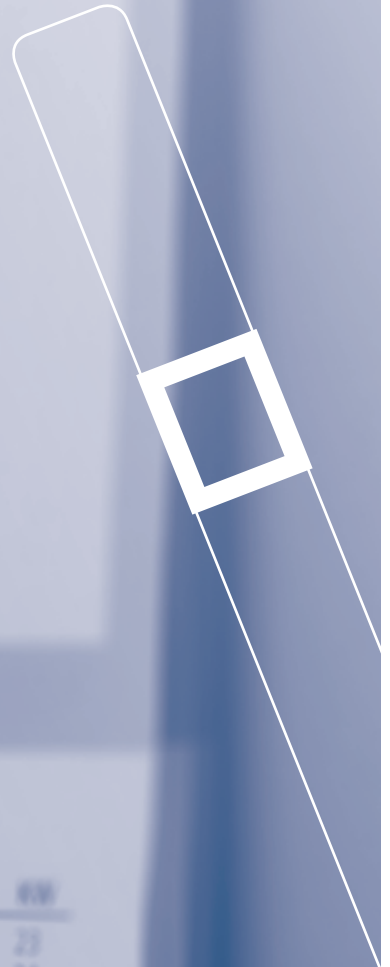
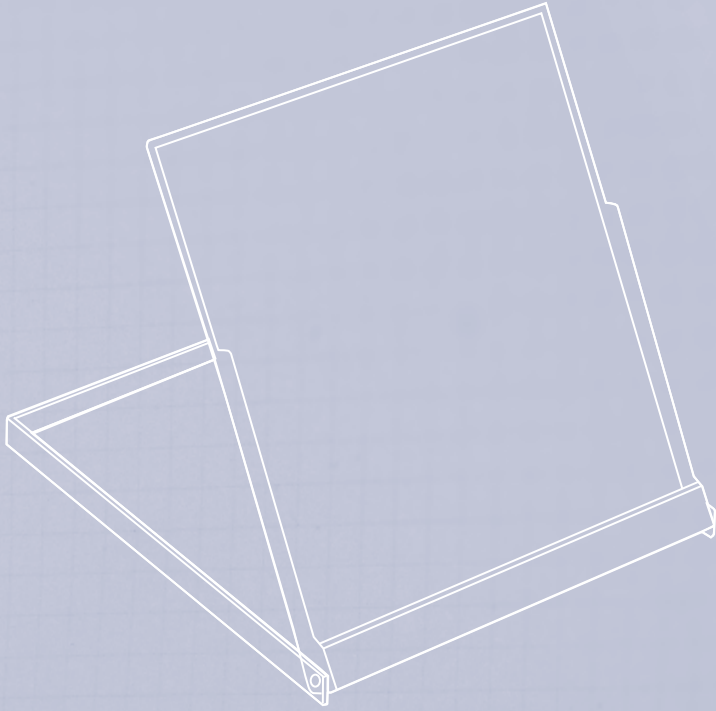

Mai							
KW	Mo	Di	Mi	Do	Fr	Sa	So
14					1	2	3
15	4	5	6	7	8	9	10
16	11	12	13	14	15	16	17
17	18	19	20	21	22	23	24
18	25	26	27	28	29	30	31

Juni							
KW	Mo	Di	Mi	Do	Fr	Sa	So
23	1	2	3	4	5	6	7
24	8	9	10	11	12	13	14
25	15	16	17	18	19	20	21
26	22	23	24	25	26	27	28
27	29	30					

Dezember							
KW	Mo	Di	Mi	Do	Fr	Sa	So
49		1	2	3	4	5	6
50	7	8	9	10	11	12	13
51	14	15	16	17	18	19	20
52	21	22	23	24	25	26	27
53	28	29	30	31			

Januar							
KW	Mo	Di	Mi	Do	Fr	Sa	So
52					1	2	3
1	4	5	6	7	8	9	10
2	11	12	13	14	15	16	17
3	18	19	20	21	22	23	24
4	25	26	27	28	29	30	31

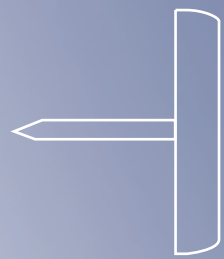

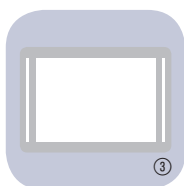
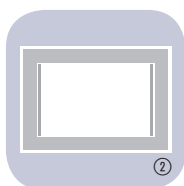
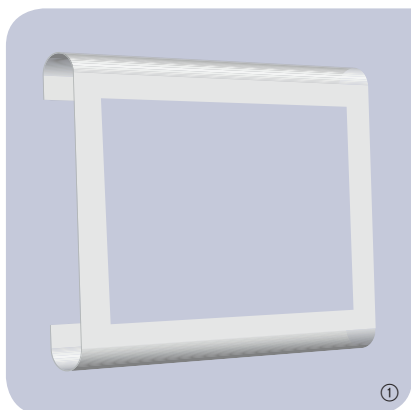

- ① **Klassikfenster**
Classic window
- ② **bedruckte Schlitzfenster**
Slot window imprinted
- ③ **Schlitzfenster**
Slot window

BEFESTIGUNGSARTEN DATUMSWEISER



mit Knebelgummi inkl. Metallsplinten



mit verknoteter Gummizugschnur

Klassikfenster mit Knebelgummi und Metallsplinten



Klassikfenster mit verknoteter Gummizugschnur



Datumsweiser mit Knebelgummi

Date indicators for three-month calendar with elastic cord

komplett montiert
three parts fully assembled

Artikel-Nr. Item no.	Ausführung Description	Innenformat (h x b) Inner size (h x w)	Außenformat (h x b) Outer size (h x w)
E1 ¹	Klassikfenster Classic window	14 x 24 mm	20 x 30 mm
E2	Klassikfenster Classic window	17 x 24 mm	23 x 30 mm
E3	Klassikfenster Classic window	20 x 28 mm	26 x 35 mm
E4	Klassikfenster Classic window	24 x 32 mm	29 x 38 mm
E5	Klassikfenster Classic window	28 x 35 mm	35 x 42 mm
E6	Klassikfenster Classic window	35 x 35 mm	41 x 43 mm
E7	Klassikfenster Classic window	17 x 34 mm	23 x 41 mm
E8	Klassikfenster Classic window	20 x 40 mm	26 x 46 mm
E9	Klassikfenster Classic window	22 x 35 mm	30 x 43 mm
E10	Klassikfenster Classic window	14 x 15 mm	20 x 21 mm
E11	Klassikfenster Classic window	14 x 20 mm	20 x 26 mm
ES1 ³	Schlitzfenster Slot window	14 x 22 mm	20 x 31 mm
ES2	Schlitzfenster Slot window	17 x 24 mm	23 x 34 mm
ES3	Schlitzfenster Slot window	20 x 31 mm	27 x 41 mm
ES4	Schlitzfenster Slot window	23 x 34 mm	31 x 44 mm
ES5	Schlitzfenster Slot window	27 x 41 mm	35 x 53 mm
ES6	Schlitzfenster Slot window	31 x 44 mm	39 x 56 mm
ES7	Schlitzfenster Slot window	19 x 38 mm	25 x 48 mm
SP1 ²	bedruckte Schlitzfenster Slot window / imprinted	16 x 27 mm	24 x 35 mm
SP2	bedruckte Schlitzfenster Slot window / imprinted	22 x 35 mm	30 x 43 mm
SP3	bedruckte Schlitzfenster Slot window / imprinted	27 x 42 mm	35 x 50 mm
SP4	bedruckte Schlitzfenster Slot window / imprinted	22 x 33 mm	30 x 41 mm
SP5	bedruckte Schlitzfenster Slot window / imprinted	17 x 33 mm	25 x 41 mm

! **Weitere Fenstergrößen auf Anfrage** | Additional date indicator sizes on request
! **Weitere Fensterfarben auf Anfrage** | Additional window colours on request



Sofort ab Lager lieferbar (mit Knebelgummi inkl. Metallsplinten)
available ex stock (with elastic cord with metal-ends)

Artikel-Nr. Item no.	Fenster-Nr. Window no.	Kalender+breite Calendar width	Farbe Colour
DW.E1.300.M.WPVC.03	E1	300 mm	rot red
DW.E2.300.M.WPVC.03	E2	300 mm	rot red
DW.E3.300.M.WPVC.03	E3	300 mm	rot red
DW.E3.300.M.WPVC.04	E3	300 mm	blau blue
DW.E3.330.M.WPVC.03	E3	330 mm	rot red
DW.E3.345.M.WPVC.03	E3	345 mm	rot red
DW.E4.300.M.WPVC.03	E4	300 mm	rot red
DW.E4.330.M.WPVC.03	E4	330 mm	rot red
DW.E7.300.M.WPVC.03	E7	300 mm	rot red
DW.E8.300.M.WPVC.03	E8	300 mm	rot red
DW.E8.300.M.WPVC.03	E8	300 mm	rot red
DW.E8.300.M.WPVC.03	E8	300 mm	rot red
DW.E2.300.M.WPVC.03	ES2	300 mm	rot red
DW.E3.300.M.WPVC.03	ES3	300 mm	rot red
DW.E3.330.M.WPVC.03	ES3	330 mm	rot red
DW.SP1.300.M.WPVC.03	SP1	300 mm	rot red
DW.SP5.300.M.WPVC.03	SP5	300 mm	rot red

Sofort ab Lager lieferbar (mit geknoteter Gummizugschnur)
available ex stock (with knotted elastic cord)

DW.E3.300.M.K.WPVC.03	E3	300 mm	rot red
-----------------------	----	--------	-----------



Kalenderzubehör Calendar accessories

KLEMMWIRKUNG

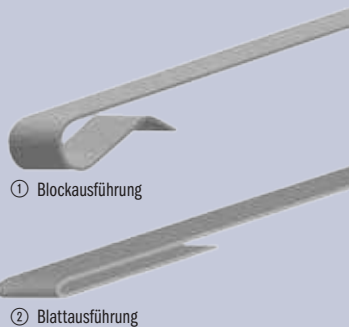

① Blockausführung

② Blattausführung

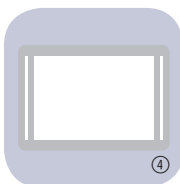
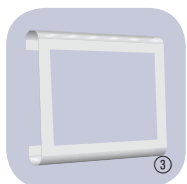

Datumsweiser für Tischkalender

Date indicators for desk calendar

komplett montiert, Fenster mit transparentem Trägerband

fully assembled, window with transparent strip

Fenster-Nr. Window no.	Ausführung Description	Innenformat (h x b) Inner size (h x w)	Außenformat (h x b) Outer size (h x w)
H1 ³	Klassikfenster <i>Classic window</i>	8 x 10 mm	12 x 14 mm
EK1 ⁴	Schlitzfenster <i>Slot window</i>	8 x 10 mm	12 x 16 mm

Sofort ab Lager lieferbar | Available ex stock

Artikel-Nr. Item no.	Fenster-Nr. Window no.	für Kalenderbreite Calendar width	Ausführung Description	Farbe Colour
DW.H1.95.M.C ¹	H1	95 mm	Block <i>block</i>	rot <i>red</i>
DW.H1.BLATT.95.M.C ²	H1	95 mm	Blatt <i>sheet</i>	rot <i>red</i>



Ringmagnet als Datumsweiser, inkl. Metallronden

Ring magnets used as date indicators, incl. metal discs

für Tischkalender, Neodym, N40

for desk calendars, neodymium, N40

Artikel-Nr. Item no.	Außen Outer	Innen Inner	Farbe Colour
SET.MS.R.15_10.ES.06	ø 15 mm	ø 10 mm	■ vernickelt <i>nickel-plated</i>



Statische Datumsweiser

Static date indicators

auf Rolle

supplied in rolls

Artikel-Nr. Item no.	Durchmesser Diameter	Ausführung Description
DW.STAT.25.03.2ER.1C ²	25 mm	Rand transluzent rot, mit aufgedrucktem Kreis 16 mm innen und 20 mm außen <i>circle translucent red, with imprinted circle inner diameter 16 mm and outer diameter 20 mm</i>
DW.STAT.28.03.2ER ¹	28 mm	transluzent rot <i>translucent red</i>
DW.STAT.28.07.2ER.1C ³	28 mm	transluzent grün (ähnlich HKS 57) <i>translucent green (similar to HKS 57)</i>

! Andere Ausführungen auf Anfrage | Different designs on request

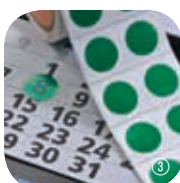

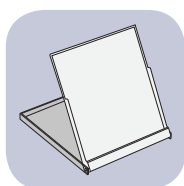

Kalenderboxen

Calendar boxes

Polystyrol, transparent

made of PS, transparent

Artikel-Nr. Item no.	Format Size	Ausführung Description
VX.092062.9.00	92 x 62 x 9 mm	Visitenkarten business card
KX.097100	96 x 98 x 9 mm	Diskette floppy disc
KX.111190 ²	111 x 190 x 7 mm	Panorama landscape
KX.125142 ¹	125 x 142 x 9 mm	CD CD
KX.153113	153 x 113 x 10 mm	DIN A6 hoch A6 vertical
KX.215153	215 x 153 x 10 mm	DIN A5, quer A5 horizontal



Schutzkanten für Schreibtischblocks DIN A2

Cover strips for A2 desk pads

selbstklebend, 594 mm lang







self-adhesive, length 594 mm

Artikel-Nr. Item no.	Ausführung Description	Farbe Colour
KA.594080.ALIS.00	ohne Verstärkung non strengthened	☐ transparent transparent
KA.594080.MH.00 ¹	mit Hartfolie verstärkt strengthened with rigid-PVC	☐ transparent transparent
KA.594095.BS.00	mit Tasche für Einleger in der Klappe with pocket for inlays	☐ transparent transparent
KA.594080.MP.01	mit Pappe verstärkt strengthened with carton	☐ weiß white
KA.594080.MP.02	mit Pappe verstärkt strengthened with carton	■ schwarz black
KA.594080.MP.03 ³	mit Pappe verstärkt strengthened with carton	■ rot (ähnlich HKS 14) red (similar HKS 14)
KA.594080.MP.04 ²	mit Pappe verstärkt strengthened with carton	■ mittelblau (ähnlich HKS 44) mid blue (similar HKS 44)
KA.594080.MP.05.A	mit Pappe verstärkt strengthened with carton	■ dunkelblau (ähnlich HKS 41) dark blue (similar HKS 41)
KA.594080.MP.07.C	mit Pappe verstärkt strengthened with carton	■ dunkelgrün (ähnlich HKS 55) dark green (similar HKS 55)



Schutzkanten für Schreibtischblocks nach Kundenwunsch

Cover strips for desk pads – customised

-  Mindestmenge: 250 Stück
minimum quantity: 250 pieces
-  Sonderformate in fast jeder gewünschten Abmessung, z.B. Klappenhöhe
custom-made in nearly all desired dimensions, e.g. flap height
-  verschiedene Folienarten, Folienstärken und Folienfarben, z.B. glasklar, matt, transluzent oder farbig
available in different foil types, thicknesses and colours, e.g. transparent, frosted, translucent or coloured
-  mit aufgeschweißter Tasche, z.B. für Visitenkarten
with welded-on pocket, e.g. for business cards
-  auf Wunsch mit eingeschweißtem, bedrucktem Pappkern
on request with welded and printed cardboard core
-  Aufdruck im Siebdruck, Offsetdruck oder mit (Blind)-Prägung
overprinted by silk screen printing, offset printing or with (blind) embossing



Plakatpieker

Poster pins

vernickelte Nadel, farbiger Kopf

nickel-plated pin, coloured pinhead

Artikel-Nr. Item no.	Durchmesser Diameter	Farbe Colour
RN.15.01	15 mm	☐ weiß white
RN.15.02	15 mm	■ schwarz black
RN.15.03	15 mm	■ rot red
RN.15.04	15 mm	■ blau blue
RN.30.01	30 mm	☐ weiß white
RN.30.02	30 mm	■ schwarz black
RN.30.03	30 mm	■ rot red
RN.30.04	30 mm	■ blau blue
RN.30.07	30 mm	■ grün green
RN.30.08	30 mm	■ gelb yellow

Plakatpieker, 4 Stück im Beutel

poster pins, 4 pieces in a zip lock bag

Artikel-Nr. Item no.	Durchmesser Diameter	Farbe Colour
RN.15.4ER.01	15 mm	☐ weiß white
RN.15.4ER.02	15 mm	■ schwarz black
RN.15.4ER.03	15 mm	■ rot red
RN.15.4ER.04	15 mm	■ blau blue
RN.15.4ER.07	15 mm	■ grün green
RN.15.4ER.08	15 mm	■ gelb yellow
RN.30.4ER.01	30 mm	☐ weiß white
RN.30.4ER.02	30 mm	■ schwarz black
RN.30.4ER.03	30 mm	■ rot red
RN.30.4ER.04	30 mm	■ blau blue
RN.30.4ER.07	30 mm	■ grün green
RN.30.4ER.08	30 mm	■ gelb yellow



Weitere Farben und Durchmesser auf Anfrage | Other colours and sizes on request



Plakatpieker nach Kundenwunsch

Poster pins – customised

 Mindestmenge: 500 Stück
minimum quantity: 500 pieces

 $\varnothing = 30$ mm mit individuellem Aufdruck
 $\varnothing = 30$ mm with customised overprint

 Farbe nach Wahl
colour of choice



Datums- oder Aktenklammern

Date or file clips

Kunststoff

plastic

Artikel-Nr. Item no.	Format Size	Sperrweite Capacity	Farbe Colour
AK.010025.01	10 x 25 mm	6 mm	☐ weiß white
AK.010025.02	10 x 25 mm	6 mm	■ schwarz black
AK.010025.03	10 x 25 mm	6 mm	■ rot red
AK.010025.04 ¹	10 x 25 mm	6 mm	■ blau blue
AK.010025.07	10 x 25 mm	6 mm	■ grün green
AK.010025.08	10 x 25 mm	6 mm	■ gelb yellow
AK.015025.01	15 x 25 mm	7 mm	☐ weiß white
AK.015025.02	15 x 25 mm	7 mm	■ schwarz black
AK.015025.03	15 x 25 mm	7 mm	■ rot red
AK.015025.04	15 x 25 mm	7 mm	■ blau blue
AK.015025.07	15 x 25 mm	7 mm	■ grün green
AK.015025.08 ²	15 x 25 mm	7 mm	■ gelb yellow
AK.015050.01	15 x 50 mm	13 mm	☐ weiß white
AK.015050.02	15 x 50 mm	13 mm	■ schwarz black
AK.015050.03	15 x 50 mm	13 mm	■ rot red
AK.015050.04	15 x 50 mm	13 mm	■ blau blue
AK.015050.07	15 x 50 mm	13 mm	■ grün green
AK.015050.08	15 x 50 mm	13 mm	■ gelb yellow
AK.025043.01 ³	25 x 43 mm	19 mm	☐ weiß white
AK.025043.02	25 x 43 mm	19 mm	■ schwarz black
AK.025043.03	25 x 43 mm	19 mm	■ rot red
AK.025043.04	25 x 43 mm	19 mm	■ blau blue
AK.025043.07	25 x 43 mm	19 mm	■ grün green
AK.025043.08	25 x 43 mm	19 mm	■ gelb yellow

! Weitere Farben auf Anfrage | Other colours on request



Kalenderzubehör

Calendar accessories



Pfeilclip

Arrow clips

Kunststoff
plastic

Artikel-Nr. | Item no. **Farbe | Colour**

AK.PF.30.03 ¹ ■ rot | red

AK.PF.30.04 ² ■ blau | blue



Pfeilclips nach Kundenwunsch

Arrow clips – customised

 Mindestmenge: 500 Stück
minimum quantity: 500 pieces

 diverse Ausführungen / Formen
various shapes

 Farbe nach Wahl
colour of choice



Plakataufhänger

Poster hangers

zum Ankleben auf einem Plakat oder einem Kalender
for sticking onto posters or calendars

Artikel-Nr. | Item no. **Format | Size** **Ausführung | Description**

PA.30.01 ¹ ø 30 mm mit gewelltem Rand, aus weißem Shirting, mit vermessingter Dreiecksöse, mit Gummierung zum Anfeuchten
with curled edge, made of white shirting, brass-plated triangular eyelet and rubber coating for moistening

PA.45.01 ³ ø 45 mm mit gewelltem Rand, aus weißem Shirting, mit vermessingter Dreiecksöse, mit Gummierung zum Anfeuchten
with curled edge, made of white shirting, brass-plated triangular eyelet and rubber coating for moistening

PA.017028.SK.01.400 17 x 28 mm aus doppeltem weißen Papier, mit eingeklebter Schnur, selbstklebend, in Spenderbox
made of double-layered white paper, with glued-in string, self-adhesive, in dispenser box

PA.024031.01 ² 24 x 31 mm aus doppeltem weißen Papier, mit eingeklebter Schnur, mit Gummierung zum Anfeuchten
made of double-layered white paper, with glued-in string, and rubber coating for moistening





Kalenderaufhänger

Calendar hangers

zum Einbinden in Drahtbinderücken, 2 mm dick
for inserting into wire bindings, 2 mm thick

Artikel-Nr. Item no.	Länge Length	Farbe Colour
DB.KA.102.01	102 mm	<input type="checkbox"/> weiß white
DB.KA.102.02	102 mm	<input checked="" type="checkbox"/> schwarz black
DB.KA.102.06	102 mm	<input checked="" type="checkbox"/> silber (nc) silver (nc)
DB.KA.150.01	150 mm	<input type="checkbox"/> weiß white
DB.KA.150.02	150 mm	<input checked="" type="checkbox"/> schwarz black
DB.KA.150.06	150 mm	<input checked="" type="checkbox"/> silber (nc) silver (nc)
DB.KA.200.01	200 mm	<input type="checkbox"/> weiß white
DB.KA.200.02	200 mm	<input checked="" type="checkbox"/> schwarz black
DB.KA.200.06	200 mm	<input checked="" type="checkbox"/> silber (nc) silver (nc)
DB.KA.250.01	250 mm	<input type="checkbox"/> weiß white
DB.KA.250.02	250 mm	<input checked="" type="checkbox"/> schwarz black
DB.KA.250.06	250 mm	<input checked="" type="checkbox"/> silber (nc) silver (nc)



Schäfte für Kalenderaufhänger

Straight wire shafts for calendar hangers

zum Einbinden in Drahtbinderücken
for inserting into wire bindings

Artikel-Nr. Item no.	Länge Length	Farbe Colour
DB.SKA.88.01 ¹	80 / 88 mm	<input type="checkbox"/> weiß white
DB.SKA.88.02 ²	80 / 88 mm	<input checked="" type="checkbox"/> schwarz black
DB.SKA.88.06 ²	80 / 88 mm	<input checked="" type="checkbox"/> silber (nc) silver (nc)
DB.SKA.113.01	105 / 113 mm	<input type="checkbox"/> weiß white
DB.SKA.113.02	105 / 113 mm	<input checked="" type="checkbox"/> schwarz black
DB.SKA.113.06	105 / 113 mm	<input checked="" type="checkbox"/> silber (nc) silver (nc)
DB.SKA.158.01	150 / 158 mm	<input type="checkbox"/> weiß white
DB.SKA.158.02	150 / 158 mm	<input checked="" type="checkbox"/> schwarz black
DB.SKA.158.06	150 / 158 mm	<input checked="" type="checkbox"/> silber (nc) silver (nc)
DB.SKA.208.01	200 / 208 mm	<input type="checkbox"/> weiß white
DB.SKA.208.02	200 / 208 mm	<input checked="" type="checkbox"/> schwarz black
DB.SKA.208.06	200 / 208 mm	<input checked="" type="checkbox"/> silber (nc) silver (nc)
DB.SKA.298.01	290 / 298 mm	<input type="checkbox"/> weiß white
DB.SKA.298.02	290 / 298 mm	<input checked="" type="checkbox"/> schwarz black
DB.SKA.298.06	290 / 298 mm	<input checked="" type="checkbox"/> silber (nc) silver (nc)
DB.SKA.358.01	350 / 358 mm	<input type="checkbox"/> weiß white
DB.SKA.358.02	350 / 358 mm	<input checked="" type="checkbox"/> schwarz black
DB.SKA.358.06	350 / 358 mm	<input checked="" type="checkbox"/> silber (nc) silver (nc)

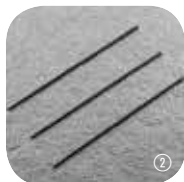



Klebpunkte & Klebeband
Adhesive discs & tapes

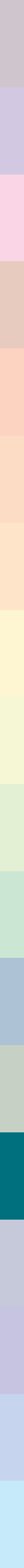



Klebspunkte & Klebeband

Adhesive discs & tapes

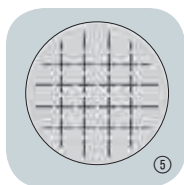
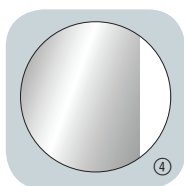
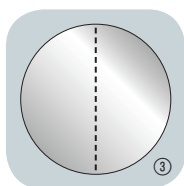
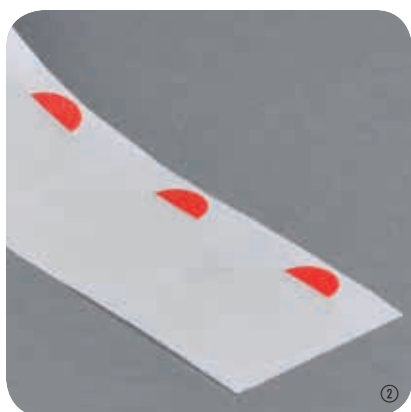

Einseitige Klebspunkte, transparent

Single-sided adhesive discs, transparent

schwach haftend
removable adhesive

Artikel-Nr. Item no.	Durchmesser / Ausführung Diameter / Description	Stückzahl / Rolle Pieces per roll
KP.10.A.1000	10 mm	1.000 St. 1,000 pcs.
KP.10.A.5000	10 mm	5.000 St. 5,000 pcs.
KP.15.A.5000	15 mm	5.000 St. 5,000 pcs.
KP.20.A.1000	20 mm	1.000 St. 1,000 pcs.
KP.20.A.5000	20 mm	5.000 St. 5,000 pcs.
KP.25.A.PERF.1000 ³	25 mm, mittig perforiert center perforated	1.000 St. 1,000 pcs.
KP.25.A.PERF.4000 ³	25 mm, mittig perforiert center perforated	4.000 St. 4,000 pcs.
KP.25.A.1000	25 mm	1.000 St. 1,000 pcs.
KP.25.A.4000	25 mm	4.000 St. 4,000 pcs.
KP.28.A.AL.2000 ^{2,4}	28 mm, mit Anfasslasche with strap	2.000 St. 2,000 pcs.
KP.30.A.1000	30 mm	1.000 St. 1,000 pcs.
KP.30.A.3000 ¹	30 mm	3.000 St. 3,000 pcs.
NEU KP.40.A.1000.331	40 mm	1.000 St. 1,000 pcs.
NEU KP.40.A.2500.331	40 mm	2.500 St. 2,500 pcs.
NEU KP.50.A.1000.331	50 mm	1.000 St. 1,000 pcs.
NEU KP.50.A.2500.331	50 mm	2.500 St. 2,500 pcs.

stark haftend
permanent adhesive

Artikel-Nr. Item no.	Durchmesser / Ausführung Diameter / Description	Stückzahl / Rolle Pieces per roll
KP.10.P.1000	10 mm	1.000 St. 1,000 pcs.
KP.10.P.5000	10 mm	5.000 St. 5,000 pcs.
KP.15.P.1000	15 mm	1.000 St. 1,000 pcs.
KP.15.P.5000	15 mm	5.000 St. 5,000 pcs.
KP.20.P.1000	20 mm	1.000 St. 1,000 pcs.
KP.20.P.5000	20 mm	5.000 St. 5,000 pcs.
KP.20.P.PERF.1000 ³	20 mm, mittig perforiert center perforated	1.000 St. 1,000 pcs.
KP.20.P.PERF.5000 ³	20 mm, mittig perforiert center perforated	5.000 St. 5,000 pcs.
KP.25.P.1000	25 mm	1.000 St. 1,000 pcs.
KP.25.P.4000	25 mm	4.000 St. 4,000 pcs.
KP.25.P.PERF.1000 ³	25 mm, mittig perforiert center perforated	1.000 St. 1,000 pcs.
KP.25.P.PERF.4000 ³	25 mm, mittig perforiert center perforated	4.000 St. 4,000 pcs.
KP.25.P.8PERF.1000 ⁵	25 mm, Multiperforation multi perforated	1.000 St. 1,000 pcs.
KP.25.P.8PERF.4000 ⁵	25 mm, Multiperforation multi perforated	4.000 St. 4,000 pcs.
KP.30.P.1000	30 mm	1.000 St. 1,000 pcs.
KP.30.P.3000	30 mm	3.000 St. 3,000 pcs.
KP.30.P.PERF.1000 ³	30 mm, mittig perforiert center perforated	1.000 St. 1,000 pcs.
KP.30.P.PERF.3000 ³	30 mm, mittig perforiert center perforated	3.000 St. 3,000 pcs.
NEU KP.35.P.1000.331	35 mm	1.000 St. 1,000 pcs.
NEU KP.35.P.3000.331	35 mm	3.000 St. 3,000 pcs.
NEU KP.35.P.PERF.1000.331 ³	35 mm, mittig perforiert center perforated	1.000 St. 1,000 pcs.
NEU KP.35.P.PERF.3000.331 ³	35 mm, mittig perforiert center perforated	3.000 St. 3,000 pcs.
KP.40.P.1000	40 mm	1.000 St. 1,000 pcs.
KP.40.P.2500	40 mm	2.500 St. 2,500 pcs.
KP.40.P.PERF.2500 ³	40 mm, mittig perforiert center perforated	2.500 St. 2,500 pcs.
KP.50.P.1000	50 mm	1.000 St. 1,000 pcs.
KP.50.P.2500	50 mm	2.500 St. 2,500 pcs.
NEU KP.50.P.PERF.1000.331 ³	50 mm, mittig perforiert center perforated	1.000 St. 1,000 pcs.
NEU KP.50.P.PERF.2500.331 ³	50 mm, mittig perforiert center perforated	2.500 St. 2,500 pcs.
NEU KP.60.P.1000.331	60 mm	1.000 St. 1,000 pcs.
NEU KP.60.P.2500.331	60 mm	2.500 St. 2,500 pcs.
NEU KP.75.P.1000.331	75 mm	1.000 St. 1,000 pcs.
NEU KP.8050.P.1000.331	80 x 50 mm	1.000 St. 1,000 pcs.
NEU KP.100.P.1000.331	100 mm	1.000 St. 1,000 pcs.









Klebspunkte & Klebeband

Adhesive discs & tapes



Einseitige Klebspunkte nach Kundenwunsch

Adhesive discs - customised

-  Mindestmenge: 50.000 Stück
minimum quantity: 50,000 pieces
-  Sonderformate und Sonderformen in jeder gewünschten Abmessung
custom-made adhesive disc designs available in nearly all desired dimensions
-  verschiedene Materialien, z.B. Papier, Folie, Gewebe, etc.
different materials, e.g. paper, foil, fabric, etc.
-  verschiedene Farben, z.B. glasklar, weiß oder farbig
different colours, e.g. transparent, white or coloured
-  stark oder schwach haftend
permanent or removable adhesion
-  Aufdruck im Flexodruck oder Offsetdruck
overprint with flexo printing or offset printing
-  Sonderausführungen, z.B. Rubbeletikett, Fensterhinterklebung oder mit Blackmark möglich
special versions available, e.g. scratch-off labels, window pane displays or with black mark



Spender für Klebspunkte

Dispenser for self-adhesive discs

für einseitige und doppelseitige Klebspunkte, inkl. Rollentrennern

for single-sided and double-sided discs with roll holders

Artikel-Nr. Item no.	Breite Width	Ausführung Description
KP.SPENDER.T.75.04	bis 75 mm max. 75 mm	2 Trenner 2 adjustable roll holders
KP.SPENDER.T.75.0T ²	bis 75 mm max. 75 mm	ohne Trenner without roll holders
KP.SPENDER.T.113.04 ¹	bis 113 mm max. 113 mm	2 Trenner 2 adjustable roll holders
KP.SPENDER.T.113.1T.04A ³	bis 113 mm max. 113 mm	1 Trenner 1 adjustable roll holder
KP.SPENDER.T.162.04	bis 162 mm max. 162 mm	2 Trenner 2 adjustable roll holders
KP.SPENDER.W.75.11	Wand- und Tischspender für Klebspunkte, grau <i>Dispenser for arranging on tables or mounting on walls, grey</i>	

Zubehör | Attachments

KP.SPENDER.T.TRENN.11¹ Kunststoff Rollentrenner für Spender, grau | *Roll separator for dispenser, grey*

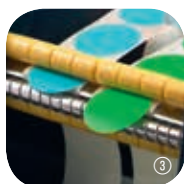

Spenderbox für einseitige Klebspunkte

Dispenser box for adhesive discs

Karton, passend für die Durchmesser 15, 20, 25, und 30 mm

box, for diameters 15, 20, 25 and 30 mm

Artikel-Nr. | Item no.

KP.SPENDER.20.25.30

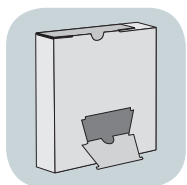



Klebpunkte & Klebeband

Adhesive discs & tapes

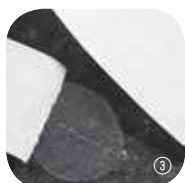

Handabroller System für einseitige Klebpunkte

Hand dispenser system for single-sided adhesive discs

Klebpunkte einseitig stark haftend, transparent

single-sided adhesive discs, transparent

Artikel-Nr. Item no.	Durchmesser / Ausführung Diameter / Description	Stückzahl / Rolle Pieces per roll	Ausführung Description
KP.HA.20.P.1500 ²	20 mm	1.500 St. 1,500 pcs.	Kerndurchmesser: 25 mm, Aussendurchmesser: 75 mm core diameter: 25 mm, outer diameter: 75 mm
KP.HA.20.P.PERF.1500 ³	20 mm, mittig perforiert 20 mm, center perforated	1.500 St. 1,500 pcs.	Kerndurchmesser: 25 mm, Aussendurchmesser: 75 mm core diameter: 25 mm, outer diameter: 75 mm
KP.HA.25.P.1500	25 mm	1.500 St. 1,500 pcs.	Kerndurchmesser: 25 mm, Aussendurchmesser: 85 mm core diameter: 25 mm, outer diameter: 85 mm
KP.HA.25.P.PERF.1500	25 mm, mittig perforiert 25 mm, center perforated	1.500 St. 1,500 pcs.	Kerndurchmesser: 25 mm, Aussendurchmesser: 85 mm core diameter: 25 mm, outer diameter: 85 mm

Handabroller E2025 | Hand dispenser E2025

KP.SPENDER.HA.E2025¹ für einseitige Klebpunkte mit 20 oder 25 mm Durchmesser, Rollenkerndurchmesser: 25 mm, Außendurchmesser: bis 100 mm
for single-sided adhesive discs with $\phi = 20$ and 25 mm, on rolls with core diameter: 25 mm, outer diameter: until 100 mm

Aktionsetiketten

Sales labels

NEU
now in stock

Durchmesser 30 mm, leuchtrot, einseitig stark haftend

Diameter 30 mm, fluorescent red, single sided permanent adhesive

Artikel-Nr. Item no.	Motiv Motive	Stückzahl / Rolle Pieces per roll
KP.AE.30.P.SP.03L.1000 ¹	SONDERPREIS	1.000 St. 1,000 pcs.
KP.AE.30.P.SA.03L.1000 ²	SONDERANGEBOT	1.000 St. 1,000 pcs.
KP.AE.30.P.RED.03L.1000 ³	REDUZIERT	1.000 St. 1,000 pcs.
KP.AE.30.P.RED20.03L.1000 ⁴	REDUZIERT 20%	1.000 St. 1,000 pcs.
KP.AE.30.P.RED30.03L.1000 ⁵	REDUZIERT 30%	1.000 St. 1,000 pcs.
KP.AE.30.P.RED50.03L.1000	REDUZIERT 50%	1.000 St. 1,000 pcs.





Klebpunkte & Klebeband

Adhesive discs & tapes



Farbige Klebpunkte

Coloured adhesive discs

einseitig stark haftend, aus Papier

single-sided adhesive, permanent, made of paper

Artikel-Nr. Item no.	Durchmesser Diameter	Farbe Colour	Stückzahl / Rolle Pieces per roll
KP.13.P.01.1000	13 mm	□ weiß white	1.000 St. 1,000 pcs.
KP.13.P.02.1000	13 mm	■ schwarz black	1.000 St. 1,000 pcs.
KP.13.P.03.1000	13 mm	■ rot (ähnlich HKS 12K) red (similar HKS 12K)	1.000 St. 1,000 pcs.
KP.13.P.04.1000	13 mm	■ hellblau (ähnlich HKS 50K) light blue (similar HKS 50K)	1.000 St. 1,000 pcs.
KP.13.P.05.1000	13 mm	■ königsblau (ähnlich HKS 43K) royal blue (similar HKS 43K)	1.000 St. 1,000 pcs.
KP.13.P.07.1000	13 mm	■ hellgrün (ähnlich HKS 66K) light green (similar HKS 66K)	1.000 St. 1,000 pcs.
KP.13.P.07D.1000	13 mm	■ dunkelgrün (ähnlich HKS 54K) dark green (similar HKS 54K)	1.000 St. 1,000 pcs.
KP.13.P.08.1000	13 mm	■ gelb (ähnlich HKS 2K) yellow (similar HKS 2K)	1.000 St. 1,000 pcs.
KP.13.P.09.1000	13 mm	■ orange (ähnlich HKS 7K) orange (similar HKS 7K)	1.000 St. 1,000 pcs.
KP.13.P.17D.1000	13 mm	■ dunkelbraun (ähnlich HKS 84K) brown (similar HKS 84K)	1.000 St. 1,000 pcs.
KP.20.P.01.1000	20 mm	□ weiß white	1.000 St. 1,000 pcs.
KP.20.P.02.1000	20 mm	■ schwarz black	1.000 St. 1,000 pcs.
KP.20.P.03.1000 ¹	20 mm	■ rot (ähnlich HKS 12K) red (similar HKS 12K)	1.000 St. 1,000 pcs.
KP.20.P.04.1000 ²	20 mm	■ hellblau (ähnlich HKS 50K) light blue (similar HKS 50K)	1.000 St. 1,000 pcs.
KP.20.P.05.1000	20 mm	■ königsblau (ähnlich HKS 43K) royal blue (similar HKS 43K)	1.000 St. 1,000 pcs.
KP.20.P.07H.1000 ³	20 mm	■ hellgrün (ähnlich HKS 66K) light green (similar HKS 66K)	1.000 St. 1,000 pcs.
KP.20.P.07D.1000	20 mm	■ dunkelgrün (ähnlich HKS 54K) dark green (similar HKS 54K)	1.000 St. 1,000 pcs.
KP.20.P.08.1000	20 mm	■ gelb (ähnlich HKS 2K) yellow (similar HKS 2K)	1.000 St. 1,000 pcs.
KP.20.P.09.1000	20 mm	■ orange (ähnlich HKS 7K) orange (similar HKS 7K)	1.000 St. 1,000 pcs.
KP.20.P.17.1000	20 mm	■ dunkelbraun (ähnlich HKS 84K) brown (similar HKS 84K)	1.000 St. 1,000 pcs.
KP.30.P.01.1000	30 mm	□ weiß white	1.000 St. 1,000 pcs.
KP.30.P.02.1000	30 mm	■ schwarz black	1.000 St. 1,000 pcs.
KP.30.P.03.1000	30 mm	■ rot (ähnlich HKS 12K) red (similar HKS 12K)	1.000 St. 1,000 pcs.
KP.30.P.04.1000	30 mm	■ hellblau (ähnlich HKS 50K) light blue (similar HKS 50K)	1.000 St. 1,000 pcs.
KP.30.P.05.1000	30 mm	■ königsblau (ähnlich HKS 43K) royal blue (similar HKS 43K)	1.000 St. 1,000 pcs.
KP.30.P.07H.1000	30 mm	■ hellgrün (ähnlich HKS 66K) light green (similar HKS 66K)	1.000 St. 1,000 pcs.
KP.30.P.07D.1000	30 mm	■ dunkelgrün (ähnlich HKS 54K) dark green (similar HKS 54K)	1.000 St. 1,000 pcs.
KP.30.P.08.1000	30 mm	■ gelb (ähnlich HKS 2K) yellow (similar HKS 2K)	1.000 St. 1,000 pcs.
KP.30.P.09.1000	30 mm	■ orange (ähnlich HKS 7K) orange (similar HKS 7K)	1.000 St. 1,000 pcs.
KP.30.P.17.1000	30 mm	■ dunkelbraun (ähnlich HKS 84K) brown (similar HKS 84K)	1.000 St. 1,000 pcs.



Klebpunkte & Klebeband

Adhesive discs & tapes



Doppelseitige Klebpunkte, transparent

Double-sided adhesive discs, transparent

stark / schwach haftend, PET-Folie, mit Anfasslasche, auf Rolle

permanent / removable adhesive, PET foil, with strap, supplied in rolls

Artikel-Nr. Item no.	Durchmesser Diameter	Stückzahl / Rolle Pieces per roll
KP.10.P_A.AL.1000	10 mm	1.000 St. 1,000 pcs.
KP.10.P_A.AL.5000	10 mm	5.000 St. 5,000 pcs.
KP.15.P_A.AL.1000	15 mm	1.000 St. 1,000 pcs.
KP.15.P_A.AL.5000	15 mm	5.000 St. 5,000 pcs.
KP.20.P_A.AL.1000	20 mm	1.000 St. 1,000 pcs.
KP.20.P_A.AL.5000 ¹	20 mm	5.000 St. 5,000 pcs.
KP.25.P_A.AL.1000	25 mm	1.000 St. 1,000 pcs.
KP.25.P_A.AL.5000	25 mm	5.000 St. 5,000 pcs.
KP.30.P_A.AL.1000	30 mm	1.000 St. 1,000 pcs.
KP.30.P_A.AL.5000 ³	30 mm	5.000 St. 5,000 pcs.

stark / stark haftend, Papiervlies, mit Anfasslasche

permanent / permanent adhesive, tissue tape, with strap

Artikel-Nr. Item no.	Durchmesser Diameter	Stückzahl / Rolle Pieces per roll
KP.10.P_P.AL.1000	10 mm	1.000 St. 1,000 pcs.
KP.10.P_P.AL.5000	10 mm	5.000 St. 5,000 pcs.
KP.15.P_P.AL.1000 ²	15 mm	1.000 St. 1,000 pcs.
KP.15.P_P.AL.5000	15 mm	5.000 St. 5,000 pcs.
KP.20.P_P.AL.1000	20 mm	1.000 St. 1,000 pcs.
KP.20.P_P.AL.5000	20 mm	5.000 St. 5,000 pcs.
KP.25.P_P.AL.1000	25 mm	1.000 St. 1,000 pcs.
KP.25.P_P.AL.5000	25 mm	5.000 St. 5,000 pcs.
KP.30.P_P.AL.1000	30 mm	1.000 St. 1,000 pcs.
KP.30.P_P.AL.5000	30 mm	5.000 St. 5,000 pcs.
NEU KP.50.P_P.AL.100	50 mm	100 St. 100 pcs.
KP.50.P_P.AL.2500	50 mm	2.500 St. 2,500 pcs.

schwach / schwach haftend, PET-Folie, mit Anfasslasche

removable / removable adhesive, PET foil, with strap

Artikel-Nr. Item no.	Durchmesser Diameter	Stückzahl / Rolle Pieces per roll
KP.10.A_A.AL.1000	10 mm	1.000 St. 1,000 pcs.
KP.10.A_A.AL.5000	10 mm	5.000 St. 5,000 pcs.
KP.15.A_A.AL.1000	15 mm	1.000 St. 1,000 pcs.
KP.15.A_A.AL.5000	15 mm	5.000 St. 5,000 pcs.
KP.20.A_A.AL.1000	20 mm	1.000 St. 1,000 pcs.
KP.20.A_A.AL.5000	20 mm	5.000 St. 5,000 pcs.
KP.30.A_A.AL.1000	30 mm	1.000 St. 1,000 pcs.
KP.30.A_A.AL.5000	30 mm	5.000 St. 5,000 pcs.



Klebpunkte & Kleband

Adhesive discs & tapes



Doppelseitige Klebpunkte aus Reinacrylat, hochtransparent

Double-sided adhesive discs acrylic foam, highly transparent

mit Anfasslasche, stark / stark haftend
with strap, permanent / permanent adhesive

Artikel-Nr. Item no.	Durchmesser Diameter	Stärke Thickness	Stückzahl / Rolle Pieces per roll
NEU KP.10.P_PAF.AL.100	10 mm	1 mm	100 St. 100 pcs.
KP.10.P_PAF.AL.1000	10 mm	1 mm	1.000 St. 1,000 pcs.
KP.10.P_PAF.AL.3000	10 mm	1 mm	3.000 St. 3,000 pcs.
NEU KP.15.P_PAF.O_5.AL.1000	15 mm	0,5 mm	1.000 St. 1,000 pcs.
NEU KP.15.P_PAF.O_5.AL.3000	15 mm	0,5 mm	3.000 St. 3,000 pcs.
NEU KP.15.P_PAF.AL.100	15 mm	1 mm	100 St. 100 pcs.
KP.15.P_PAF.AL.1000	15 mm	1 mm	1.000 St. 1,000 pcs.
KP.15.P_PAF.AL.3000 ¹	15 mm	1 mm	3.000 St. 3,000 pcs.
NEU KP.20.P_PAF.O_5.AL.1000	20 mm	0,5 mm	1.000 St. 1,000 pcs.
NEU KP.20.P_PAF.O_5.AL.3000	20 mm	0,5 mm	3.000 St. 3,000 pcs.
NEU KP.20.P_PAF.AL.100	20 mm	1 mm	100 St. 100 pcs.
KP.20.P_PAF.AL.1000	20 mm	1 mm	1.000 St. 1,000 pcs.
KP.20.P_PAF.AL.3000	20 mm	1 mm	3.000 St. 3,000 pcs.
NEU KP.25.P_PAF.AL.100	25 mm	1 mm	100 St. 100 pcs.
KP.25.P_PAF.AL.1000	25 mm	1 mm	1.000 St. 1,000 pcs.
KP.25.P_PAF.AL.3000	25 mm	1 mm	3.000 St. 3,000 pcs.
NEU KP.30.P_PAF.AL.100	30 mm	1 mm	100 St. 100 pcs.
KP.30.P_PAF.AL.1000	30 mm	1 mm	1.000 St. 1,000 pcs.
KP.30.P_PAF.AL.3000	30 mm	1 mm	3.000 St. 3,000 pcs.



Doppelseitige Klebpunkte aus PE-Schaum, weiß

Double-sided adhesive discs PE foam, white

mit Anfasslasche, stark / stark haftend
with strap, permanent / permanent adhesive

Artikel-Nr. Item no.	Durchmesser Diameter	Stärke Thickness	Stückzahl / Rolle Pieces per roll
KP.10.P_P.PE.AL.1000	10 mm	1 mm	1.000 St. 1,000 pcs.
KP.10.P_P.PE.AL.5000	10 mm	1 mm	5.000 St. 5,000 pcs.
KP.10.P_P.PE2.AL.2500	10 mm	2 mm	2.500 St. 2,500 pcs.
KP.10.P_P.PE3.AL.2500	10 mm	3 mm	2.500 St. 2,500 pcs.
KP.12.P_P.PE.AL.1000	12 mm	1 mm	1.000 St. 1,000 pcs.
KP.12.P_P.PE.AL.5000	12 mm	1 mm	5.000 St. 5,000 pcs.
KP.15.P_P.PE.AL.1000	15 mm	1 mm	1.000 St. 1,000 pcs.
KP.15.P_P.PE.AL.5000	15 mm	1 mm	5.000 St. 5,000 pcs.
KP.20.P_P.PE.AL.1000	20 mm	1 mm	1.000 St. 1,000 pcs.
KP.20.P_P.PE.AL.5000 ¹	20 mm	1 mm	5.000 St. 5,000 pcs.
KP.20.P_P.PE2.AL.2500	20 mm	2 mm	2.500 St. 2,500 pcs.
NEU KP.25.P_P.PE.AL.100	25 mm	1 mm	100 St. 100 pcs.
KP.25.P_P.PE.AL.2500	25 mm	1 mm	2.500 St. 2,500 pcs.
NEU KP.30.P_P.PE.AL.100	25 mm	1 mm	100 St. 100 pcs.
KP.30.P_P.PE.AL.2500	30 mm	1 mm	2.500 St. 2,500 pcs.

ohne Anfasslasche, stark / stark haftend
without strap, permanent / permanent adhesive

Artikel-Nr. Item no.	Durchmesser Diameter	Stärke Thickness	Stückzahl / Rolle Pieces per roll
KP.17_5.P_P.PE.10000 ²	17,5 mm	1 mm	10.000 St. (8-bahnig) 10,000 pcs. (8 lines per roll)







Klebspunkte & Klebeband

Adhesive discs & tapes



Doppelseitige Klebspunkte nach Kundenwunsch

Double-sided adhesive discs – customised

-  Mindestmenge: 50.000 Stück
minimum quantity: 50,000 pieces
-  Sonderformate und Sonderformen in fast jeder gewünschten Abmessung
special sizes or special shapes in nearly all desired dimensions
-  verschiedene Trägermaterialien, z.B. Papier, Folie, PE-Schaum, etc.
different base materials, e.g. paper foil, PE foam, etc.
-  stark / stark oder stark / schwach haftend
permanent / permanent or permanent / removable adhesive
-  mit oder ohne Anfasflasche
with or without strap



Gewebeklebspunkte

Fabric adhesive discs

einseitig stark haftend

single-sided adhesive



NEU

Artikel-Nr. Item no.	Durchmesser Diameter	Farbe Colour	Stückzahl / Rolle Pieces per roll
KP.30.P.GW.01.2500	ø 30 mm	□ weiß white	2.500 St. 2,500 pcs.
KP.30.P.GW.02.2500	ø 30 mm	■ schwarz black	2.500 St. 2,500 pcs.
KP.30.P.GW.03.2500	ø 30 mm	■ rot red	2.500 St. 2,500 pcs.
KP.30.P.GW.05.2500	ø 30 mm	■ blau blue	2.500 St. 2,500 pcs.
KP.30.P.GW.06.1000	ø 30 mm	■ silber silver	1.000 St. 1,000 pcs.
KP.30.P.GW.06.1B.2000 ³	ø 30 mm	■ silber silver	2.000 St. 2,000 pcs.
KP.30.P.GW.06.4000	ø 30 mm	■ silber silver	4.000 St. 4,000 pcs.
KP.30.P.GW.07.2500	ø 30 mm	■ grün green	2.500 St. 2,500 pcs.
KP.30.P.GW.08.2500	ø 30 mm	■ gelb yellow	2.500 St. 2,500 pcs.
KP.3030.P.GW.06.2000 ²	30 x 30 mm	■ silber silver	2.000 St. 2,000 pcs.
KP.40.P.GW.06.2500 ¹	ø 40 mm	■ silber silver	2.500 St. 2,500 pcs.



Silikonlebspunkte für Handabroller (siehe Seite 5.9)

Glue dots for tape gun (see page 5.9)

Artikel-Nr. Item no.	Durchmesser Diameter	Klebestärke Adhesion	Stückzahl / Rolle Pieces per roll
GPL.10.HA.1500 ¹	8-10 mm	schwach removable	1.500 St. 1,500 pcs.
GPM.10.HA.1500	8-10 mm	halb-permanent semi-permanent	1.500 St. 1,500 pcs.
GPH.10.HA.1500	8-10 mm	stark permanent	1.500 St. 1,500 pcs.



Klebpunkte & Klebeband

Adhesive discs & tapes



Silikonklebpunkte

Glue dots

in Spenderschachtel

in dispenser box

Artikel-Nr. Item no.	Durchmesser Diameter	Klebestärke Adhesion	Stückzahl / Rolle Pieces per roll
GP.L.6.5000 ¹	6 mm	schwach removable	5.000 St. 5,000 pcs.
GP.M.6.5000	6 mm	halb-permanent semi-permanent	5.000 St. 5,000 pcs.
GP.L.10.1000	8-10 mm	schwach removable	1.000 St. 1,000 pcs.
GP.L.10.5000	8-10 mm	schwach removable	5.000 St. 5,000 pcs.
GP.M.10.1000	8-10 mm	halb-permanent semi-permanent	1.000 St. 1,000 pcs.
GP.M.10.5000	8-10 mm	halb-permanent semi-permanent	5.000 St. 5,000 pcs.
GP.H.10.1000	8-10 mm	stark permanent	1.000 St. 1,000 pcs.
GP.H.10.5000	8-10 mm	stark permanent	5.000 St. 5,000 pcs.
GP.L.1030.1000	10 x 30 mm	schwach removable	1.000 St. 1,000 pcs.
GP.L.1030.3000 ²	10 x 30 mm	schwach removable	3.000 St. 3,000 pcs.
GP.M.1030.1000	10 x 30 mm	halb-permanent semi-permanent	1.000 St. 1,000 pcs.
GP.M.1030.3000	10 x 30 mm	halb-permanent semi-permanent	3.000 St. 3,000 pcs.
GP.L.12.1000	12 mm	schwach removable	1.000 St. 1,000 pcs.
GP.L.12.5000	12 mm	schwach removable	5.000 St. 5,000 pcs.
GP.M.12.1000	12 mm	halb-permanent semi-permanent	1.000 St. 1,000 pcs.
GP.M.12.5000	12 mm	halb-permanent semi-permanent	5.000 St. 5,000 pcs.
NEU GP.H.12.1000	12 mm	stark permanent	1.000 St. 1,000 pcs.
NEU GP.H.12.5000	12 mm	stark permanent	5.000 St. 5,000 pcs.
NEU GP.L.15.1000	15 mm	schwach removable	1.000 St. 1,000 pcs.
NEU GP.L.15.5000	15 mm	schwach removable	5.000 St. 5,000 pcs.
NEU GP.M.15.1000	15 mm	halb-permanent semi-permanent	1.000 St. 1,000 pcs.
NEU GP.M.15.5000	15 mm	halb-permanent semi-permanent	5.000 St. 5,000 pcs.
NEU GP.H.15.1000	15 mm	stark permanent	1.000 St. 1,000 pcs.
NEU GP.H.15.5000	15 mm	stark permanent	5.000 St. 5,000 pcs.



Klebspender / Einwegroller

Tape dispenser

Klebestreifen 8,4 mm breit, schwach haftend

adhesive tape 8.4 mm width, removable adhesive

Artikel-Nr. Item no.	Länge / Rolle Length per roll
DK.8_4.A.14 ¹	14 m
DK.8_4.P.30 ²	30 m



Klebspunkte & Klebeband

Adhesive discs & tapes



Transferklebeband für ATG-System

Transfer tapes for ATG adhesive system

stark / stark haftend

permanent / permanent adhesive

Artikel-Nr. Item no.	Ausführung Type	Meter / Rolle Meters per roll
DK.ATG.6.P_P.33 *	ATG-Klebstoff-Film Best Price, 6 mm breit ATG Adhesive film Best Price, 6 mm wide	33 m
NEU DK.ATG.6.P_P.55	ATG-Klebstoff-Film Best Price, 6 mm breit ATG Adhesive film Best Price, 6 mm wide	55 m
DK.ATG.9.P_P.33	ATG-Klebstoff-Film Best Price, 9 mm breit ATG Adhesive film Best Price, 9 mm wide	33 m
NEU DK.ATG.9.P_P.55	ATG-Klebstoff-Film Best Price, 9 mm breit ATG Adhesive film Best Price, 9 mm wide	55 m
DK.ATG.12.P_P.33	ATG-Klebstoff-Film Best Price, 12 mm breit ATG Adhesive film Best Price, 12 mm wide	33 m
NEU DK.ATG.12.P_P.55	ATG-Klebstoff-Film Best Price, 12 mm breit ATG Adhesive film Best Price, 12 mm wide	55 m
DK.ATG.19.P_P.33	ATG-Klebstoff-Film Best Price, 19 mm breit ATG Adhesive film Best Price, 19 mm wide	33 m
NEU DK.ATG.19.P_P.55	ATG-Klebstoff-Film Best Price, 19 mm breit ATG Adhesive film Best Price, 19 mm wide	55 m
DK.ATG.6.PF.P_P.33 *	ATG-Klebstoff-Film Performance, 6 mm breit ATG-Tape, Performance, 6 mm wide	33 m
DK.ATG.9.PF.P_P.33	ATG-Klebstoff-Film Performance, 9 mm breit ATG-Tape, Performance, 9 mm wide	33 m
DK.ATG.12.PF.P_P.33 ²	ATG-Klebstoff-Film Performance, 12 mm breit ATG-Tape, Performance, 12 mm wide	33 m
DK.ATG.19.PF.P_P.33	ATG-Klebstoff-Film Performance, 19 mm breit ATG-Tape, Performance, 19 mm wide	33 m
DK.ATG.6.U.P_P.16_5 *	ATG-Klebstoff-Film Ultra, 6 mm breit ATG-Tape, Ultra, 6mm wide	16,5 m
DK.ATG.9.U.P_P.16_5	ATG-Klebstoff-Film Ultra, 9 mm breit ATG-Tape, Ultra, 9 mm wide	16,5 m
DK.ATG.12.U.P_P.16_5	ATG-Klebstoff-Film Ultra, 12 mm breit ATG-Tape, Ultra, 12 mm wide	16,5 m
DK.ATG.19.U.P_P.16_5	ATG-Klebstoff-Film Ultra, 19 mm breit ATG-Tape, Ultra, 19 mm wide	16,5 m
DK.6.P_P.904.44 ^{Scotch} *	ATG-Klebstoff-Film 904, 6 mm breit ATG-Tape 904, 6 mm wide	44 m
DK.12.P_P.904.44 ^{Scotch}	ATG-Klebstoff-Film 904, 12 mm breit ATG-Tape 904, 12 mm wide	44 m
DK.19.P_P.904.44 ^{Scotch}	ATG-Klebstoff-Film 904, 19 mm breit ATG-Tape 904, 19 mm wide	44 m
DK.6.P_P.924.55 ^{Scotch} *	ATG-Klebstoff-Film 924, 6 mm breit ATG-Tape 924, 6 mm wide	55 m
DK.12.P_P.924.55 ^{Scotch}	ATG-Klebstoff-Film 924, 12 mm breit ATG-Tape 924, 12 mm wide	55 m
DK.19.P_P.924.55 ^{Scotch}	ATG-Klebstoff-Film 924, 19 mm breit ATG-Tape 924, 19 mm wide	55 m
DK.6.P_P.969.33 ^{Scotch} *	ATG-Klebstoff-Film 969, 6 mm breit ATG-Tape 969, 6 mm wide	33 m
DK.12.P_P.969.33 ^{Scotch}	ATG-Klebstoff-Film 969, 12 mm breit ATG-Tape 969, 12 mm wide	33 m
DK.19.P_P.969.33 ^{Scotch}	ATG-Klebstoff-Film 969, 19 mm breit ATG-Tape 969, 19 mm wide	33 m

schwach / schwach haftend

removable / removable adhesive

Artikel-Nr. Item no.	Ausführung Type	Meter / Rolle Meters per roll
DK.ATG.9.A_A.50	ATG-Klebstoff-Film, 9 mm breit ATG Adhesive film, 9 mm wide	50 m
DK.ATG.12.A_A.50	ATG-Klebstoff-Film, 12 mm breit ATG Adhesive film, 12 mm wide	50 m

Handabroller und Zubehör | Tape gun and accessories

Artikel-Nr. Item no.	Ausführung Type
DK.ATG700 ¹	Scotch ATG-700 Handabroller für doppelseitige Klebstoff-Filme Scotch ATG tape gun 700 for double sided adhesive tapes
DK.ATG700.ADAPT ³	Adapter für 6 mm Klebstoff-Filme adapter for 6 mm adhesive tape
SET.DK.ATG900 ⁴	Handabroller für doppelseitige Klebstoff-Filme inklusive Adapter zur Verarbeitung von 6 mm Klebefilm Tape gun 900 for double sided adhesive tapes incl. adapter for for 6 mm adhesive tapes



* Nur mit Adapter zu verarbeiten | * Adapter required



Klebspunkte & Klebeband

Adhesive discs & tapes



Elektronischer Klebebandspender A1200

Electronic dispenser for adhesive tapes A1200

programmierbar, 3 Betriebsarten
programmable, 3 modes

Artikel-Nr. | Item no.

DK.SPENDER.A1200

Details | Details

Automatikbetrieb mit Sensor | automatic mode with sensor

manueller Betrieb | manual mode

vordefinierte Menge | predefined quantity

6 unterschiedliche Bandlängeneinstellungen speicherbar | with memory for 6 different settings of tape length
auch für 2 Klebebandrollen gleichzeitig geeignet | it is possible to use 2 tape rolls at one time



Doppelseitiges Klebeband

Double-sided adhesive tape

Trägermaterial Papiervlies, Gesamtdicke 100 µm
carrier material tissue tape, total thickness 100 micron

Artikel-Nr. Item no.	Breite Width	Ausführung Adhesion	Meter / Rolle Meters per roll
DK.4.P_P.50 ¹	4 mm	stark / stark permanent / permanent	50 m
DK.6.P_P.50	6 mm	stark / stark permanent / permanent	50 m
DK.9.P_P.50	9 mm	stark / stark permanent / permanent	50 m
DK.9.P_P.250	9 mm	stark / stark permanent / permanent	250 m
DK.12.P_P.50	12 mm	stark / stark permanent / permanent	50 m
DK.12.P_P.250 ²	12 mm	stark / stark permanent / permanent	250 m
DK.15.P_P.50	15 mm	stark / stark permanent / permanent	50 m
DK.15.P_P.250	15 mm	stark / stark permanent / permanent	250 m
DK.19.P_P.50	19 mm	stark / stark permanent / permanent	50 m
DK.19.P_P.250	19 mm	stark / stark permanent / permanent	250 m



Doppelseitiges Klebeband, stark / schwach

Double-sided adhesive tape, permanent / removable

auf Rollen mit 50 m
on rolls with 50 m

Artikel-Nr. Item no.	Breite Width	Ausführung Adhesion
DK.6.P_A.177B.50	6 mm	stark / schwach permanent / removable
DK.9.P_A.177B.50	9 mm	stark / schwach permanent / removable
DK.12.P_A.177B.50	12 mm	stark / schwach permanent / removable
DK.15.P_A.177B.50	15 mm	stark / schwach permanent / removable
DK.19.P_A.177B.50	19 mm	stark / schwach permanent / removable
DK.25.P_A.177B.50	15 mm	stark / schwach permanent / removable



Klebpunkte & Klebeband

Adhesive discs & tapes

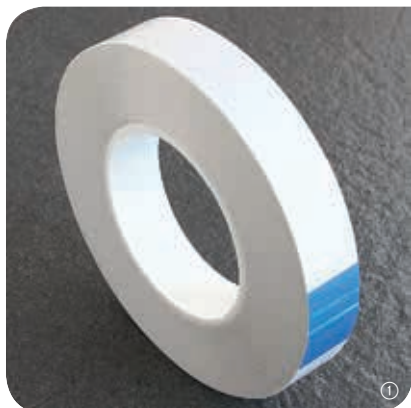

Doppelseitiges Klebeband High-Performance

Double-sided adhesive tape high performance

Trägermaterial Papiervlies, Gesamtdicke 150 µm

carrier material tissue tape, total thickness 150 micron

Artikel-Nr. Item no.	Breite Width	Ausführung Adhesion	Meter / Rolle Meters per roll
DK.6.P_P.177C.50	6 mm	stark / stark permanent / permanent	50 m
DK.9.P_P.177C.50	9 mm	stark / stark permanent / permanent	50 m
DK.9.P_P.177C.250	9 mm	stark / stark permanent / permanent	250 m
DK.12.P_P.177C.50	12 mm	stark / stark permanent / permanent	50 m
DK.12.P_P.177C.250	12 mm	stark / stark permanent / permanent	250 m
DK.15.P_P.177C.50 ¹	15 mm	stark / stark permanent / permanent	50 m
DK.15.P_P.177C.250	15 mm	stark / stark permanent / permanent	250 m
DK.19.P_P.177C.50	19 mm	stark / stark permanent / permanent	50 m
DK.19.P_P.177C.520 ²	19 mm	stark / stark permanent / permanent	250 m
DK.25.P_P.177C.50	25 mm	stark / stark permanent / permanent	50 m
DK.30.P_P.177C.50	30 mm	stark / stark permanent / permanent	50 m
DK.40.P_P.177C.50	40 mm	stark / stark permanent / permanent	50 m
DK.50.P_P.177C.50	50 mm	stark / stark permanent / permanent	50 m
DK.75.P_P.177C.50	75 mm	stark / stark permanent / permanent	50 m
DK.100.P_P.177C.50	100 mm	stark / stark permanent / permanent	50 m
DK.150.P_P.177C.50	150 mm	stark / stark permanent / permanent	50 m
NEU DK.210.P_P.177C.50	210 mm	stark / stark permanent / permanent	50 m
NEU DK.300.P_P.177C.50	300 mm	stark / stark permanent / permanent	50 m



Doppelseitiges Klebeband 3M 9086

Double-sided adhesive tape 3M 9086

auf Rollen mit 50 m, Trägermaterial Papiervlies, Gesamtdicke 190 µm

rolls with 50 m, tissue tape, total thickness 190 micron

Artikel-Nr. Item no.	Breite Width	Ausführung Adhesion
DK.6.P_P.3M9086.50 ¹	6 mm	stark / stark permanent / permanent
DK.9.P_P.3M9086.50	9 mm	stark / stark permanent / permanent
DK.12.P_P.3M9086.50	12 mm	stark / stark permanent / permanent
DK.15.P_P.3M9086.50	15 mm	stark / stark permanent / permanent
DK.19.P_P.3M9086.50	19 mm	stark / stark permanent / permanent
DK.25.P_P.3M9086.50	25 mm	stark / stark permanent / permanent



Klebpunkte & Klebeband

Adhesive discs & tapes



Doppelseitiges Klebeband Fingerlift

Double-sided adhesive tape with fingerlift

Abdeckpapier überstehend

wider masking paper

Artikel-Nr. Item no.	Breite Width	Ausführung Adhesion	Meter / Rolle Meters per roll
DK.6_12.P_P.50	6 mm	stark / stark, Abdeckpapier 12 mm permanent / permanent, fingerlift 12 mm	50 m
DK.6_12.P_P.500	6 mm	stark / stark, Abdeckpapier 12 mm permanent / permanent, fingerlift 12 mm	500 m
DK.10_15.P_A.177B.50	10 mm	stark / schwach, Abdeckpapier 15 mm permanent / removable, fingerlift 15 mm	50 m
DK.10_15.P_P.50	10 mm	stark / stark, Abdeckpapier 15 mm permanent / permanent, fingerlift 15 mm	50 m
DK.10_15.P_P.500	10 mm	stark / stark, Abdeckpapier 15 mm permanent / permanent, fingerlift 15 mm	500 m
DK.12_18.P_P.50	12 mm	stark / stark, Abdeckpapier 18 mm permanent / permanent, fingerlift 18 mm	50 m
DK.12_18.P_P.500	12 mm	stark / stark, Abdeckpapier 18 mm permanent / permanent, fingerlift 18 mm	500 m
DK.18_24.P_P.50	18 mm	stark / stark, Abdeckpapier 24 mm permanent / permanent, fingerlift 24 mm	50 m
DK.18_24.P_P.500	18 mm	stark / stark, Abdeckpapier 24 mm permanent / permanent, fingerlift 24 mm	500 m



Doppelseitiges Hochleistungs-Klebeband, PET Folienträger

Double-sided high performance adhesive tape, PET foil

auf Rollen mit 50 m, transparenter Kleber, Gesamtdicke 205 µm

rolls with 50 m, transparent glue, total thickness 205 micron

Artikel-Nr. Item no.	Breite Width	Ausführung Adhesion
DK.6.P_P.PET.50	6 mm	stark / stark permanent / permanent
DK.9.P_P.PET.50	9 mm	stark / stark permanent / permanent
DK.12.P_P.PET.50	12 mm	stark / stark permanent / permanent
DK.15.P_P.PET.50	15 mm	stark / stark permanent / permanent
DK.19.P_P.PET.50 ¹	19 mm	stark / stark permanent / permanent
DK.25.P_P.PET.50	25 mm	stark / stark permanent / permanent



Doppelseitiges Hochleistungs-Klebeband 3M 9088

Double-sided high performance adhesive tape 3M 9088

auf Rollen mit 50 m, PET Folienträger, transparenter Kleber, Gesamtdicke 200 µm

rolls with 50 m, PET foil, transparent glue, total thickness 200 micron

Artikel-Nr. Item no.	Breite Width	Ausführung Adhesion
DK.6.P_P.3M9088.50 ¹	6 mm	stark / stark permanent / permanent
DK.9.P_P.3M9088.50	9 mm	stark / stark permanent / permanent
DK.12.P_P.3M9088.50	12 mm	stark / stark permanent / permanent
DK.15.P_P.3M9088.50	15 mm	stark / stark permanent / permanent
DK.19.P_P.3M9088.50	19 mm	stark / stark permanent / permanent
DK.25.P_P.3M9088.50	25 mm	stark / stark permanent / permanent



Klebspunkte & Klebeband

Adhesive discs & tapes



Doppelseitiges Hochleistungs-Klebeband, PVC Folienträger

Double-sided high performance adhesive tape, PVC foil

auf Rollen mit 50 m, weißer Kleber, Gesamtdicke 220 µm
on rolls with 50 m, white glue, total thickness 220 micron

Artikel-Nr. Item no.	Breite Width	Ausführung Adhesion
DK.6.P_P.PVC.50	6 mm	stark / stark permanent / permanent
DK.6.P_P.PVC.50	9 mm	stark / stark permanent / permanent
DK.12.P_P.PVC.50	12 mm	stark / stark permanent / permanent
DK.15.P_P.PVC.50	15 mm	stark / stark permanent / permanent
DK.19.P_P.PVC.50 ¹	19 mm	stark / stark permanent / permanent
DK.25.P_P.PVC.50	25 mm	stark / stark permanent / permanent

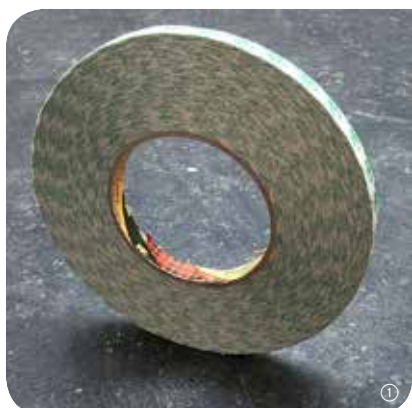

Doppelseitiges Hochleistungs-Klebeband 3M 9087

Double-sided high performance adhesive tape 3M 9087

auf Rollen mit 50 m, PVC Folienträger, weißer Kleber, Gesamtdicke 260 µm
on rolls with 50 m, PVC foil, white glue, total thickness 260 micron

Artikel-Nr. Item no.	Breite Width	Ausführung Adhesion
DK.6.P_P.3M9087.50 ¹	6 mm	stark / stark permanent / permanent
DK.9.P_P.3M9087.50	9 mm	stark / stark permanent / permanent
DK.12.P_P.3M9087.50	12 mm	stark / stark permanent / permanent
DK.15.P_P.3M9087.50	15 mm	stark / stark permanent / permanent
DK.19.P_P.3M9087.50	19 mm	stark / stark permanent / permanent
DK.25.P_P.3M9087.50	25 mm	stark / stark permanent / permanent



Doppelseitiges Reinacrylat-Klebeband

Double-sided acrylic foam tape

auf Rollen mit 33 m, hochtransparent, ca. 1 mm dick
on rolls with 33 m, highly transparent, approx. 1 mm thick

Artikel-Nr. Item no.	Breite Width	Ausführung Adhesion
DK.12.P_P.AF.33	12 mm	stark / stark permanent / permanent
DK.19.P_P.AF.33	19 mm	stark / stark permanent / permanent
DK.25.P_P.AF.33	25 mm	stark / stark permanent / permanent

! Klebeband für transparente und sehr starke Klebeverbindungen, von vielen starren Untergründen rückstandslos entfernbar.

! Adhesive tape for transparent and very strong adhesion is easily removable from many surfaces without residue.



Klebpunkte & Klebeband

Adhesive discs & tapes



Doppelseitiges Klebeband PE-Schaum





Double-sided adhesive tape PE foam

Artikel-Nr. Item no.	Breite Width	Dicke Thickness	Ausführung Adhesion	Farbe Color	Meter / Rolle Meters per roll
DK.9.P_P.PE.50	9 mm	1 mm	stark / stark permanent / permanent	☐ weiß white	50 m
DK.12.P_P.PE.50 ¹	12 mm	1 mm	stark / stark permanent / permanent	☐ weiß white	50 m
DK.12.P_P.PE.02.50	12 mm	1 mm	stark / stark permanent / permanent	■ schwarz black	50 m
DK.12.P_P.PE2.25	12 mm	2 mm	stark / stark permanent / permanent	☐ weiß white	25 m
DK.15.P_P.PE.50	15 mm	1 mm	stark / stark permanent / permanent	☐ weiß white	50 m
DK.15.P_P.PE.02.50	15 mm	1 mm	stark / stark permanent / permanent	■ schwarz black	50 m
DK.15.P_P.PE2.25	15 mm	2 mm	stark / stark permanent / permanent	☐ weiß white	25 m
DK.19.P_P.PE.50	19 mm	1 mm	stark / stark permanent / permanent	☐ weiß white	50 m
DK.19.P_P.PE.02.50 ²	19 mm	1 mm	stark / stark permanent / permanent	■ schwarz black	50 m
DK.19.P_P.PE2.25	19 mm	2 mm	stark / stark permanent / permanent	☐ weiß white	25 m
DK.25.P_P.PE.50	25 mm	1 mm	stark / stark permanent / permanent	☐ weiß white	50 m
DK.30.P_P.PE.50	30 mm	1 mm	stark / stark permanent / permanent	☐ weiß white	50 m
NEU DK.40.P_P.PE.50	40 mm	1 mm	stark / stark permanent / permanent	☐ weiß white	50 m
NEU DK.50.P_P.PE.50	50 mm	1 mm	stark / stark permanent / permanent	☐ weiß white	50 m



Doppelseitiges Klebeband nach Kundenwunsch

Double-sided adhesive tape - customised

-  Mindestmenge: 1.000 m
minimum quantity: 1,000 m
-  Sonderbreiten in fast jeder gewünschten Abmessung
custom-made in nearly all desired dimensions
-  verschiedene Materialien als Trägermaterial, z.B. Papier, Folie, PE-Schaum, etc.
different base materials e.g. paper, foil, PE foam, etc.
-  stark / stark, stark / schwach oder kundenspezifisch haftend
permanent / permanent, high / low adhesion or customised
-  mit oder ohne Fingerlift (= breiteres Abdeckpapier für eine einfachere Verklebung)
with or without fingerlift



Klebspunkte & Klebeband

Adhesive discs & tapes



PP-Packband, fadenverstärkt

Packaging tape, reinforced

50 mm breit, einseitig stark haftend, leise abrollend, PP-Folie 28 µm, auf Rollen mit 66 m
50 mm wide, single-sided permanent adhesive, low noise, PP foil 28 micron, on rolls with 66 m

Artikel-Nr. Item no.	Farbe Colour	Ausführung Description
------------------------	----------------	--------------------------

VP.PB.50.PP.FV.00 ¹	transparent transparent	fadenverstärkt reinforced
--------------------------------	---------------------------	-----------------------------

VP.PB.50.PP.FV.17 ²	braun brown	fadenverstärkt reinforced
--------------------------------	---------------	-----------------------------



PP-Packband

Packaging tape

50 mm breit, einseitig stark haftend, leise abrollend, PP-Folie 28 µm, auf Rollen mit 66 m
50 mm wide, single-sided permanent adhesive, low noise, PP foil 28 micron, on rolls with 66 m

Artikel-Nr. Item no.	Farbe Colour
------------------------	----------------

VP.PB.50.PP.00	transparent transparent
----------------	---------------------------

VP.PB.50.PP.17	braun brown
----------------	---------------



Handabroller PREMIUM für Packbänder

Hand-held tape dispenser PREMIUM for packaging tapes

für Packbänder mit 50 mm Breite, aktiven Messerschutz, Softhandgriff und Bremse
for packaging tapes with a width of 50 mm, with knife-guard, soft grip and brake

Artikel-Nr. Item no.

VP.PB.HA.PREMIUM





Klettpunkte & Klettband
Hook & loop fasteners

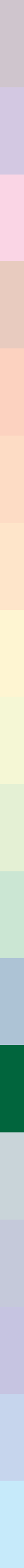



Klettunkte & Klettband

Hook & loop fasteners



Klettunkte

Hook and loop fasteners - coins

selbstklebend, bestehend aus Haken und Flausch (getrennt auf Rolle)
self-adhesive, hook and loop fasteners (delivered on separate rolls)

Artikel-Nr. Item no.	Durchmesser Diameter	Farbe Colour
SET.KT.10.01	10 mm	<input type="checkbox"/> weiß white
SET.KT.10.02	10 mm	<input checked="" type="checkbox"/> schwarz black
SET.KT.13.01	13 mm	<input type="checkbox"/> weiß white
SET.KT.13.02	13 mm	<input checked="" type="checkbox"/> schwarz black
SET.KT.16.01 ¹	16 mm	<input type="checkbox"/> weiß white
SET.KT.16.02 ²	16 mm	<input checked="" type="checkbox"/> schwarz black
SET.KT.21.01	21 mm	<input type="checkbox"/> weiß white
SET.KT.21.02	21 mm	<input checked="" type="checkbox"/> schwarz black
SET.KT.33.01	33 mm	<input type="checkbox"/> weiß white
SET.KT.33.02	33 mm	<input checked="" type="checkbox"/> schwarz black
SET.KT.45.01	45 mm	<input type="checkbox"/> weiß white
SET.KT.45.02	45 mm	<input checked="" type="checkbox"/> schwarz black
SET.KT.80.01	80 mm	<input type="checkbox"/> weiß white
SET.KT.80.02 ³	80 mm	<input checked="" type="checkbox"/> schwarz black



Klettunkte, extra-dünn

Hook and loop fasteners - coins, extra thin

mit Anfasslasche, bestehend aus Haken und Flausch (paarweise auf Rolle)
with strap, hook and loop materials (on rolls in pair)

Artikel-Nr. Item no.	Format Size	Farbe Colour
KT.15.M.SET.01	15 mm	<input type="checkbox"/> transluzent weiß translucent white
KT.20.M.SET.01	20 mm	<input type="checkbox"/> transluzent weiß translucent white

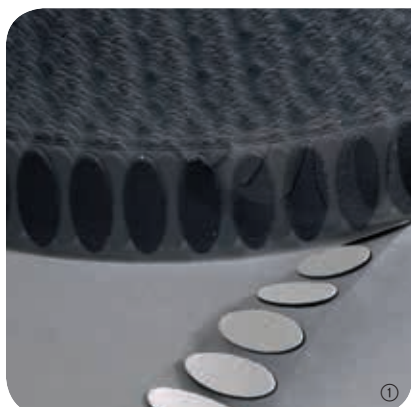

Klett-Ellipsen

Hook and loop fasteners - ellipses

selbstklebend, oval, extra dünnes Klettmaterial, bestehend aus Haken + Flausch (paarweise auf Rolle)
self-adhesive, oval, extra-thin hook and loop material (on roll in pairs)

Artikel-Nr. Item no.	Format Size	Farbe Colour
KT.D.3512.01	35 x 12 mm	<input type="checkbox"/> weiß white
KT.D.3512.02 ¹	35 x 12 mm	<input checked="" type="checkbox"/> schwarz black



Klettunkte & Klettband

Hook & loop fasteners



①



②

Klettband, selbstklebend

Hook and loop fasteners - tape, self-adhesive

auf Rollen mit 25 m
on rolls with 25 m

Artikel-Nr. Item no.	Breite Width	Ausführung Type	Farbe Colour
KT.B.16.F.01	16 mm	Flausch loop	<input type="checkbox"/> weiß white
KT.B.16.H.01	16 mm	Haken hook	<input type="checkbox"/> weiß white
KT.B.16.F.02	16 mm	Flausch loop	<input checked="" type="checkbox"/> schwarz black
KT.B.16.H.02	16 mm	Haken hook	<input checked="" type="checkbox"/> schwarz black
KT.B.20.F.01	20 mm	Flausch loop	<input type="checkbox"/> weiß white
KT.B.20.H.01 ¹	20 mm	Haken hook	<input type="checkbox"/> weiß white
KT.B.20.F.02 ²	20 mm	Flausch loop	<input checked="" type="checkbox"/> schwarz black
KT.B.20.H.02	20 mm	Haken hook	<input checked="" type="checkbox"/> schwarz black
KT.B.25.F.01	25 mm	Flausch loop	<input type="checkbox"/> weiß white
KT.B.25.H.01	25 mm	Haken hook	<input type="checkbox"/> weiß white
KT.B.25.F.02	25 mm	Flausch loop	<input checked="" type="checkbox"/> schwarz black
KT.B.25.H.02	25 mm	Haken hook	<input checked="" type="checkbox"/> schwarz black
KT.B.30.F.01	30 mm	Flausch loop	<input type="checkbox"/> weiß white
KT.B.30.H.01	30 mm	Haken hook	<input type="checkbox"/> weiß white
KT.B.30.F.02	30 mm	Flausch loop	<input checked="" type="checkbox"/> schwarz black
KT.B.30.H.02	30 mm	Haken hook	<input checked="" type="checkbox"/> schwarz black
KT.B.38.F.01	38 mm	Flausch loop	<input type="checkbox"/> weiß white
KT.B.38.H.01	38 mm	Haken hook	<input type="checkbox"/> weiß white
KT.B.38.F.02	38 mm	Flausch loop	<input checked="" type="checkbox"/> schwarz black
KT.B.38.H.02	38 mm	Haken hook	<input checked="" type="checkbox"/> schwarz black
KT.B.50.F.01	50 mm	Flausch loop	<input type="checkbox"/> weiß white
KT.B.50.H.01	50 mm	Haken hook	<input type="checkbox"/> weiß white
KT.B.50.F.02	50 mm	Flausch loop	<input checked="" type="checkbox"/> schwarz black
KT.B.50.H.02	50 mm	Haken hook	<input checked="" type="checkbox"/> schwarz black



①





②

Klettbandabschnitte, selbstklebend

Hook and loop fasteners, self-adhesive

bestehend aus Haken und Flausch, paarweise
hook and loop materials, pairs

Artikel-Nr. Item no.	Format Size	Farbe Colour
KT.AS.020150.01	20 x 150 mm	<input type="checkbox"/> weiß white
KT.AS.020150.02 ²	20 x 150 mm	<input checked="" type="checkbox"/> schwarz black
 KT.AS.025025.01	25 x 25 mm	<input type="checkbox"/> weiß white
 KT.AS.025025.02	25 x 25 mm	<input checked="" type="checkbox"/> schwarz black
KT.AS.3006.01 ¹	30 x 6 mm	<input type="checkbox"/> weiß white
KT.AS.3006.02	30 x 6 mm	<input checked="" type="checkbox"/> schwarz black



Klettband zum Vernähen

Hook and loop fasteners – tape for sewing

auf Rollen mit 25 m
on rolls with 25 m

Artikel-Nr. Item no.	Breite Width	Ausführung Type	Farbe Colour
KT.NB.16.F.01	16 mm	Flausch loop	<input type="checkbox"/> weiß white
KT.NB.16.H.01	16 mm	Haken hook	<input type="checkbox"/> weiß white
KT.NB.16.F.02	16 mm	Flausch loop	<input checked="" type="checkbox"/> schwarz black
KT.NB.16.H.02	16 mm	Haken hook	<input checked="" type="checkbox"/> schwarz black
KT.NB.20.F.01	20 mm	Flausch loop	<input type="checkbox"/> weiß white
KT.NB.20.H.01	20 mm	Haken hook	<input type="checkbox"/> weiß white
KT.NB.20.F.02	20 mm	Flausch loop	<input checked="" type="checkbox"/> schwarz black
KT.NB.20.H.02	20 mm	Haken hook	<input checked="" type="checkbox"/> schwarz black
KT.NB.25.F.01	25 mm	Flausch loop	<input type="checkbox"/> weiß white
KT.NB.25.H.01	25 mm	Haken hook	<input type="checkbox"/> weiß white
KT.NB.25.F.02	25 mm	Flausch loop	<input checked="" type="checkbox"/> schwarz black
KT.NB.25.H.02	25 mm	Haken hook	<input checked="" type="checkbox"/> schwarz black
KT.NB.30.F.01	30 mm	Flausch loop	<input type="checkbox"/> weiß white
KT.NB.30.H.01	30 mm	Haken hook	<input type="checkbox"/> weiß white
KT.NB.30.F.02 ²	30 mm	Flausch loop	<input checked="" type="checkbox"/> schwarz black
KT.NB.30.H.02	30 mm	Haken hook	<input checked="" type="checkbox"/> schwarz black
KT.NB.38.F.01	38 mm	Flausch loop	<input type="checkbox"/> weiß white
KT.NB.38.H.01 ¹	38 mm	Haken hook	<input type="checkbox"/> weiß white
KT.NB.38.F.02	38 mm	Flausch loop	<input checked="" type="checkbox"/> schwarz black
KT.NB.38.H.02	38 mm	Haken hook	<input checked="" type="checkbox"/> schwarz black
KT.NB.50.F.01	50 mm	Flausch loop	<input type="checkbox"/> weiß white
KT.NB.50.H.01	50 mm	Haken hook	<input type="checkbox"/> weiß white
KT.NB.50.F.02	50 mm	Flausch loop	<input checked="" type="checkbox"/> schwarz black
KT.NB.50.H.02	50 mm	Haken hook	<input checked="" type="checkbox"/> schwarz black



Klettband, back to back

Hook and loop fasteners, back to back

auf Rollen mit 25 m
on rolls with 25 m

Artikel-Nr. Item no.	Format Size	Ausführung Type	Farbe Colour
KT.B.20.BB.01	20 mm	back to back	<input type="checkbox"/> weiß white
KT.B.20.BB.02 ¹	20 mm	back to back	<input checked="" type="checkbox"/> schwarz black
KT.B.25.BB.01	25 mm	back to back	<input type="checkbox"/> weiß white
KT.B.25.BB.02	25 mm	back to back	<input checked="" type="checkbox"/> schwarz black

Klettkabelbinder, back to back

hook and loop cable ties

Artikel-Nr. Item no.	Format Size	Ausführung Type	Farbe Colour
KT.CT.200.02 ²	12 mm	back to back	<input checked="" type="checkbox"/> schwarz black



Klettunkte & Klettband

Hook & loop fasteners



Klettbänder + Klettunkte nach Kundenwunsch

Hook and loop fasteners – tapes and coins – customised



Sonderformate und Sonderformen in jeder gewünschten Abmessung und Form, egal ob gleichschenkelig oder ungleichschenkelig

available in almost every desired size, short edge open or long edge open



auch als selbstklebende Ausführung möglich

also available as self-adhesive version



Sonderfarben, z.B. rot, blau, grün, etc.

special colours, e.g. red, blue, green, etc.



Magnete & Magnetband
Magnets & magnetic tape

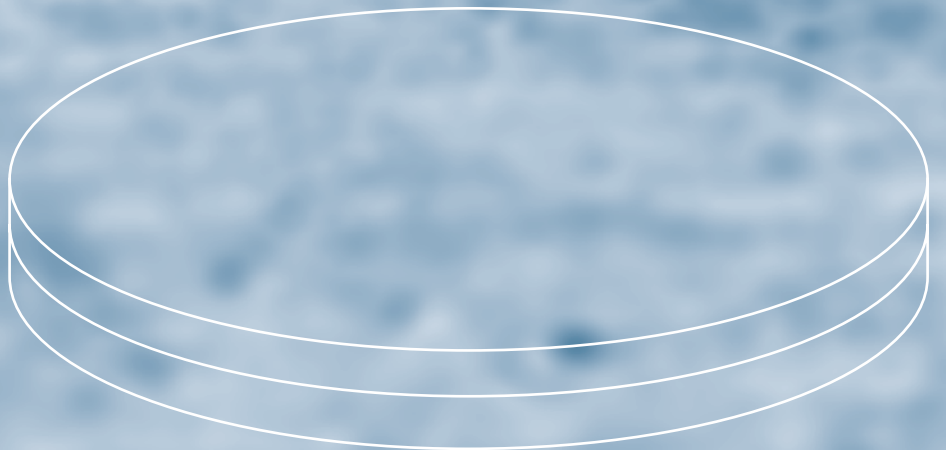
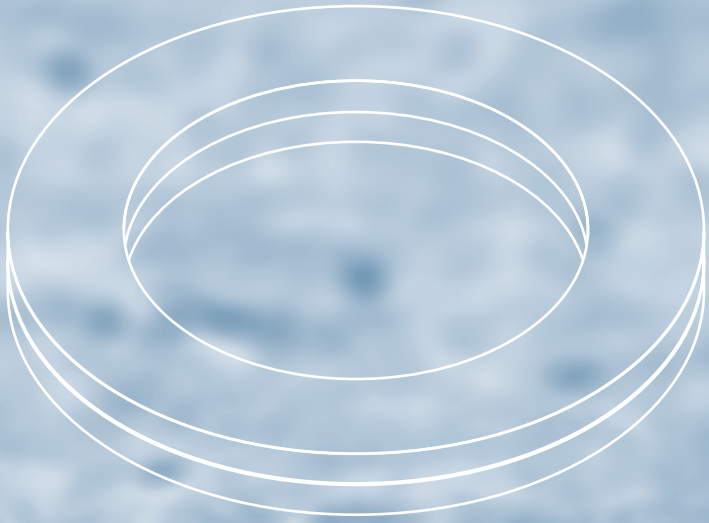



Magnete & Magnetband

Magnets & magnetic tape

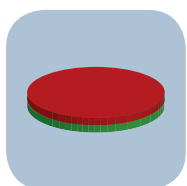

Scheibenmagnete aus Neodym

Magnetic discs neodymium

je zur Hälfte Nordpol und Südpol beschichtet

one half north pole, the other half south pole

Artikel-Nr. <i>Item no.</i>	Durchmesser <i>Diameter</i>	Stärke <i>Thickness</i>	Haftkraft (ca.) <i>Strength (approx.)</i>	Magnetisierung <i>Magnetisation</i>
MS.4.3.N35.06	4 mm	3 mm	400 g	N35
MS.5.3.N35.06	5 mm	3 mm	500 g	N35
MS.5.4.N35.06	5 mm	4 mm	600 g	N35
MS.5.5.N35.06	5 mm	5 mm	700 g	N35
MS.6.2.N35.06	6 mm	2 mm	500 g	N35
MS.7.4.N35.06	7 mm	4 mm	1.100 g	N35
MS.8.2.N35.06	8 mm	2 mm	700 g	N35
MS.8.3.N35.06	8 mm	3 mm	1.000 g	N35
MS.9_5.1_5.N35.06	9,5 mm	1,5 mm	700 g	N35
MS.9_5.2.N35.06	9,5 mm	2 mm	950 g	N35
MS.10.0_6.N38.06	10 mm	0,6 mm	250 g	N38
MS.10.1.N35.06	10 mm	1 mm	500 g	N35
MS.10.1_5.N35.06	10 mm	1,5 mm	750 g	N35
MS.10.2.N35.06	10 mm	2 mm	1.000 g	N35
NEU MS.10.2.N42.06	10 mm	2 mm	1.100 g	N42
NEU MS.10.2.N45.06	10 mm	2 mm	1.200 g	N45
MS.10.2_5.N35.06	10 mm	2,5 mm	1.300 g	N35
MS.10.3.N42.06	10 mm	3 mm	1.800 g	N42
MS.10.4.N35.06	10 mm	4 mm	1.800 g	N35
MS.10.5.N35.06	10 mm	5 mm	2.200 g	N35
MS.10.10.N35.06	10 mm	10 mm	3.000 g	N35
NEU MS.12.1.N35.06	12 mm	1 mm	500 g	N35
NEU MS.12.1_5.N35.06	12 mm	1,5 mm	1.000 g	N35
MS.12.2.N35.06	12 mm	2 mm	1.300 g	N35
NEU MS.12.2_5.N35.06	12 mm	2,5 mm	1.500 g	N35
MS.14.2.N35.06	14 mm	2 mm	1.500 g	N35
MS.15.1.N35.06	15 mm	1 mm	650 g	N35
NEU MS.15.1_5.N35.06	15 mm	1,5 mm	1.300 g	N35
MS.15.2.N35.06	15 mm	2 mm	1.600 g	N35
MS.15.2_5.N35.06	15 mm	2,5 mm	2.000 g	N35
MS.15.3.N35.06	15 mm	3 mm	2.400 g	N35
MS.15.3_5.N35.06	15 mm	3,5 mm	2.700 g	N35
MS.20.1.N35.06	20 mm	1 mm	1.000 g	N35
NEU MS.20.1_5.N35.06	20 mm	1,5 mm	1.700 g	N35
MS.20.2.N35.06	20 mm	2 mm	2.000 g	N35
NEU MS.20.3.N35.06	20 mm	3 mm	3.600 g	N35

Quadermagnet

block magnet



Artikel-Nr. <i>Item no.</i>	Format <i>Size</i>	Stärke <i>Thickness</i>	Haftkraft (ca.) <i>Strength (approx.)</i>	Magnetisierung <i>Magnetisation</i>
MS.Q.1005.1_5.N35.06	10 x 5 mm	1,5 mm	550 g	N35
MS.Q.1005.2.N35.06	10 x 5 mm	2 mm	750 g	N35
MS.Q.1010.1.N35.06	10 x 10 mm	1 mm	550 g	N35
MS.Q.1010.2.N35.06	10 x 10 mm	2 mm	1.000 g	N35
MS.Q.2005.1_5.N35.06	20 x 5 mm	1,5 mm	750 g	N35
MS.Q.2005.2.N35.06	20 x 5 mm	2 mm	1.000 g	N35
MS.Q.2010.2.N35.06	20 x 10 mm	2 mm	1.500 g	N35
NEU MS.Q.2010.2.N45.06	20 x 10 mm	2 mm	2.300 g	N45
MS.Q.2510.1_5.N35.06	25 x 10 mm	1,5 mm	1.300 g	N35
MS.Q.2510.2.N35.06	25 x 10 mm	2 mm	1.800 g	N35



Magnete & Magnetband

Magnets & magnetic tape

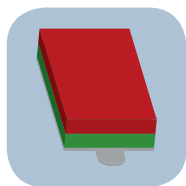
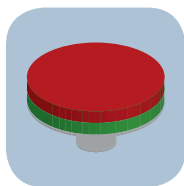
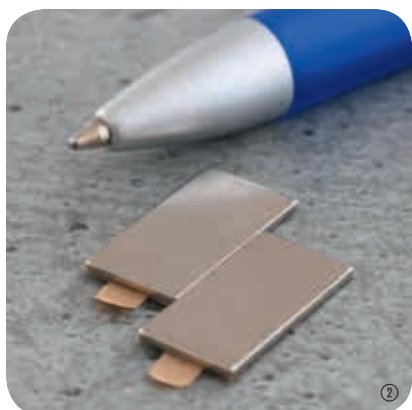

Selbstklebende Scheibenmagnete aus Neodym

Self-adhesive magnetic discs neodymium

mit Anfasslasche, paarweise (100 Stück / 50 Paar)

with strap, in pairs (100 pieces / 50 pairs)

Artikel-Nr. Item no.	Durchm. Diameter	Stärke Thickness	Haftkraft (ca.) Strength (approx.)	Magnetisierung Magnetisation	Farbe Colour
MS.6.1.SK.N45.06	6 mm	1 mm	300 g	N45	silber silver
MS.6.2.SK.06	6 mm	2 mm	500 g	N35	silber silver
MS.8.0_75.SK.06	8 mm	0,75 mm	200 g	N35	silber silver
MS.8.1.SK.N45.06	8 mm	1 mm	500 g	N45	silber silver
NEU MS.8.2.SK.06	8 mm	2 mm	700 g	N35	silber silver
NEU MS.8.3.SK.06	8 mm	3 mm	1.000 g	N35	silber silver
MS.9_5.0_75.SK.06	9,5 mm	0,75 mm	350 g	N35	silber silver
MS.9_5.1_5.SK.06	9,5 mm	1,5 mm	700 g	N35	silber silver
MS.10.0_6.SK.06	10 mm	0,6 mm	250 g	N35	silber silver
MS.10.1.SK.06	10 mm	1 mm	500 g	N35	silber silver
NEU MS.10.1.SK.02	10 mm	1 mm	500 g	N35	schwarz black
NEU MS.10.1.SK.13	10 mm	1 mm	500 g	N35	gold gold
NEU MS.10.1.SK.19	10 mm	1 mm	500 g	N35	kupfer copper
NEU MS.10.1_5.SK.06	10 mm	1,5 mm	750 g	N35	silber silver
MS.10.2.SK.06	10 mm	2 mm	1.000 g	N35	silber silver
NEU MS.10.2_5.SK.06	10 mm	2,5 mm	1.300 g	N35	silber silver
MS.10.3.SK.06	10 mm	3 mm	1.500 g	N35	silber silver
NEU MS.10.3_5.SK.06	10 mm	3,5 mm	1.700 g	N35	silber silver
MS.13.1.SK.06	13 mm	1 mm	650 g	N35	silber silver
NEU MS.13.2.SK.06	13 mm	2 mm	1.400 g	N35	silber silver
MS.15.1.SK.06	15 mm	1 mm	650 g	N35	silber silver
NEU MS.15.1_5.SK.06	15 mm	1,5 mm	1.300 g	N35	silber silver
MS.15.2.SK.06	15 mm	2 mm	1.600 g	N35	silber silver
MS.15.3.SK.06	15 mm	3 mm	2.400 g	N35	silber silver
NEU MS.18.1.SK.06	18 mm	1 mm	1.000 g	N35	silber silver
MS.20.1.SK.06 ¹	20 mm	1 mm	1.000 g	N35	silber silver
NEU MS.20.1_5.SK.06	20 mm	1,5 mm	1.700 g	N35	silber silver
MS.20.2.SK.AF.06	20 mm	2 mm	2.000 g	N35	silber silver
NEU MS.20.3.SK.AF.06	20 mm	3 mm	3.600 g	N35	silber silver
NEU MS.22.1.SK.06	22 mm	1 mm	1.200 g	N35	silber silver
MS.25.1.SK.06	25 mm	1 mm	1.300 g	N35	silber silver
NEU MS.25.2.SK.AF.06	25 mm	2 mm	3.000 g	N35	silber silver
NEU MS.30.2.SK.AF.06	30 mm	2 mm	3.300 g	N35	silber silver

Quadermagnet

block magnet

Artikel-Nr. Item no.	Format Size	Stärke Thickness	Haftkraft (ca.) Strength (approx.)	Magnetisierung Magnetisation	Farbe Colour
MS.Q.1005.1.SK.06	10 x 5 mm	1 mm	550 g	N35	silber silver
MS.Q.1010.1.SK.06	10 x 10 mm	1 mm	550 g	N35	silber silver
MS.Q.1508.1.SK.06	15 x 8 mm	1 mm	600 g	N35	silber silver
NEU MS.Q.1515.1.SK.06	15 x 15 mm	1 mm	850 g	N35	silber silver
MS.Q.2010.1.SK.06 ²	20 x 10 mm	1 mm	900 g	N35	silber silver
NEU MS.Q.2010.2.SK.06	20 x 10 mm	2 mm	1.850 g	N35	silber silver
NEU MS.Q.2020.1.SK.06	20 x 20 mm	1 mm	1.150 g	N35	silber silver
NEU MS.Q.2510.1_5.SK.06	25 x 10 mm	1,5 mm	1.600 g	N35	silber silver
NEU MS.Q.3005.1.SK.06	30 x 5 mm	1 mm	680 g	N35	silber silver
MS.Q.3010.1.SK.06	30 x 10 mm	1 mm	1.200 g	N35	silber silver
MS.Q.4012.1.SK.06	40 x 12 mm	1 mm	1.600 g	N35	silber silver
NEU MS.Q.5012.1_5.SK.06	50 x 12 mm	1,5 mm	2.400 g	N35	silber silver



Magnete & Magnetband

Magnets & magnetic tape

NEU
now in stock

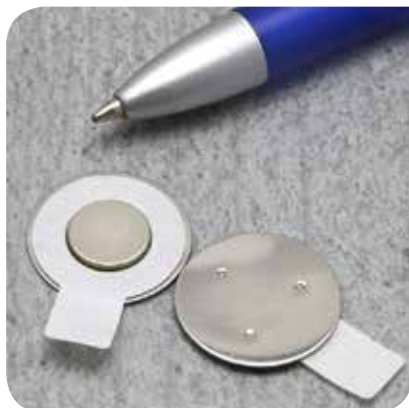

Ufo-Scheibenmagnete aus Neodym

Magnetic discs "Ufo" neodymium

auf einer Metallrunde 20 x 0,3 mm montiert, selbstklebend, mit Anfasslasche

on a metal disc 20 x 0,03 mm assembled, self-adhesive, with strap

Artikel-Nr. Item no.	Durchmesser Diameter	Stärke Thickness	Haftkraft (ca.) Strength (approx.)	Magnetisierung Magnetisation
MS.U.10.1.20.SK.N45.N.06	10 mm	1 mm	1.000 g	N45, mit Nordpol oben liegend N45, north pole located overhead
MS.U.10.1.20.SK.N45.S.06	10 mm	1 mm	1.000 g	N45, mit Südpol oben liegend N45, south pole located overhead
MS.U.10.2.20.SK.N35.N.06	10 mm	2 mm	1.000 g	N35, mit Nordpol oben liegend N35, north pole located overhead
MS.U.10.2.20.SK.N35.S.06	10 mm	2 mm	1.000 g	N35, mit Südpol oben liegend N35, south pole located overhead



auf einer Metallrunde 20 x 0,3 mm montiert, mit Anfasslasche

on a metal disc 20 x 0,03 mm assembled, with strap

Artikel-Nr. Item no.	Durchmesser Diameter	Stärke Thickness	Haftkraft (ca.) Strength (approx.)	Magnetisierung Magnetisation
MS.U.10.1.20.N45.N.06	10 mm	1 mm	1.000 g	N45, mit Nordpol oben liegend N45, north pole located overhead
MS.U.10.1.20.N45.S.06	10 mm	1 mm	1.000 g	N45, mit Südpol oben liegend N45, south pole located overhead
MS.U.10.2.20.N35.N.06	10 mm	2 mm	1.000 g	N35, mit Nordpol oben liegend N35, north pole located overhead
MS.U.10.2.20.N35.S.06	10 mm	2 mm	1.000 g	N35, mit Südpol oben liegend N35, south pole located overhead



Ringmagnete aus Neodym

Ring magnets neodymium

vernickelt

nickel-plated

Artikel-Nr. Item no.	Stärke Thickness	Außen Outer	Innen Inner	Haftkraft (ca.) Strength (approx.)	Magnetisierung Magnetisation
MS.R.15_10.2.N40.06	2 mm	ø 15 mm	ø 10 mm	800 g	N40



Metallronden

Metal discs

magnethaftend, verzinkt

magnet receiver, galvanized

Artikel-Nr. Item no.	Stärke Thickness	Durchmesser Diameter	Ausführung Description
MS.ES.11.0_3.06	0,3 mm	11 mm	
MS.ES.11.0_3.SK.06	0,3 mm	11 mm	selbstklebend mit Anfasslasche self-adhesive, with strap
MS.ES.16.0_3.06	0,3 mm	16 mm	
MS.ES.16.0_3.SK.06 ¹	0,3 mm	16 mm	selbstklebend mit Anfasslasche self-adhesive, with strap
MS.ES.21.0_3.06	0,3 mm	21 mm	
MS.ES.21.0_3.SK.06	0,3 mm	21 mm	selbstklebend mit Anfasslasche self-adhesive, with strap



Magnete & Magnetband

Magnets & magnetic tape

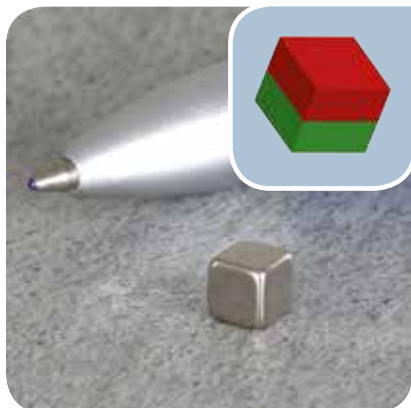

Würfelmagnete aus Neodym

Cube magnets neodymium







vernickelt
nickel-plated

Artikel-Nr. Item no.	Format Size	Haftkraft (ca.) Strength (approx.)	Magnetisierung Magnetisation
MS.W.5.N42.06	5 x 5 x 5 mm	1.100 g	N42
NEU MS.W.7.N42.06	7 x 7 x 7 mm	2.300 g	N42
NEU MS.W.10.N42.06	10 x 10 x 10 mm	5.000 g	N42



Magnete aus Neodym nach Kundenwunsch

Magnetic discs neodymium - customised

-  Sonderformate in fast jeder gewünschten Abmessung
available in almost every desired size
-  verschiedene Formen, z.B. Scheiben, Quader, Ringe oder Würfel
different versions, e.g. discs, block, rings or cubes
-  Magnetkraft von N28 bis N52 nach Ihren Wünschen
magnetisation available from N28 to N52
-  Magnetisierungsrichtung axial oder diametral wählbar
magnetisation direction axially or diametrically selectable
-  Beschichtung nach Ihren Vorgaben, vernickelt, verzinkt oder farbig lackiert
coating according to your specifications, nickel-plated, galvanized or painted
-  auch als selbstklebende Ausführung möglich
also available as self-adhesive version
-  viele verschiedene Verpackungsmöglichkeiten
many different packing options



Magnetband, selbstklebend

Magnetic tape, self-adhesive

Rolle mit 30 m, stark haftend (3M 9448), Magnetisierung anisotrop

roll with 30 m, permanent (3M 9448), magnetisation anisotropic

Artikel-Nr. Item no.	Breite Width	Stärke Thickness
MS.B.10.1.A.SK ²	10 mm	1 mm
MS.B.10.1_5.A.SK	10 mm	1,5 mm
MS.B.15.1.A.SK	15 mm	1 mm
MS.B.15.1_5.A.SK	15 mm	1,5 mm
MS.B.20.1.A.SK	20 mm	1 mm
MS.B.20.1_5.A.SK	20 mm	1,5 mm
MS.B.30.1.A.SK	30 mm	1 mm
MS.B.30.1_5.A.SK	30 mm	1,5 mm

Rolle mit 30 m, stark haftend, Magnetisierung isotrop

roll with 30 m, permanent, magnetisation isotropic

Artikel-Nr. Item no.	Breite Width	Stärke Thickness
MS.B.10.1_5.I.SK.30 ¹	10 mm	1,5 mm
MS.B.15.1_5.I.SK.30	15 mm	1,5 mm
MS.B.20.1_5.I.SK.30	20 mm	1,5 mm
MS.B.30.1_5.I.SK.30	30 mm	1,5 mm





Binderücken & Zubehör
Wire bindings & accessories

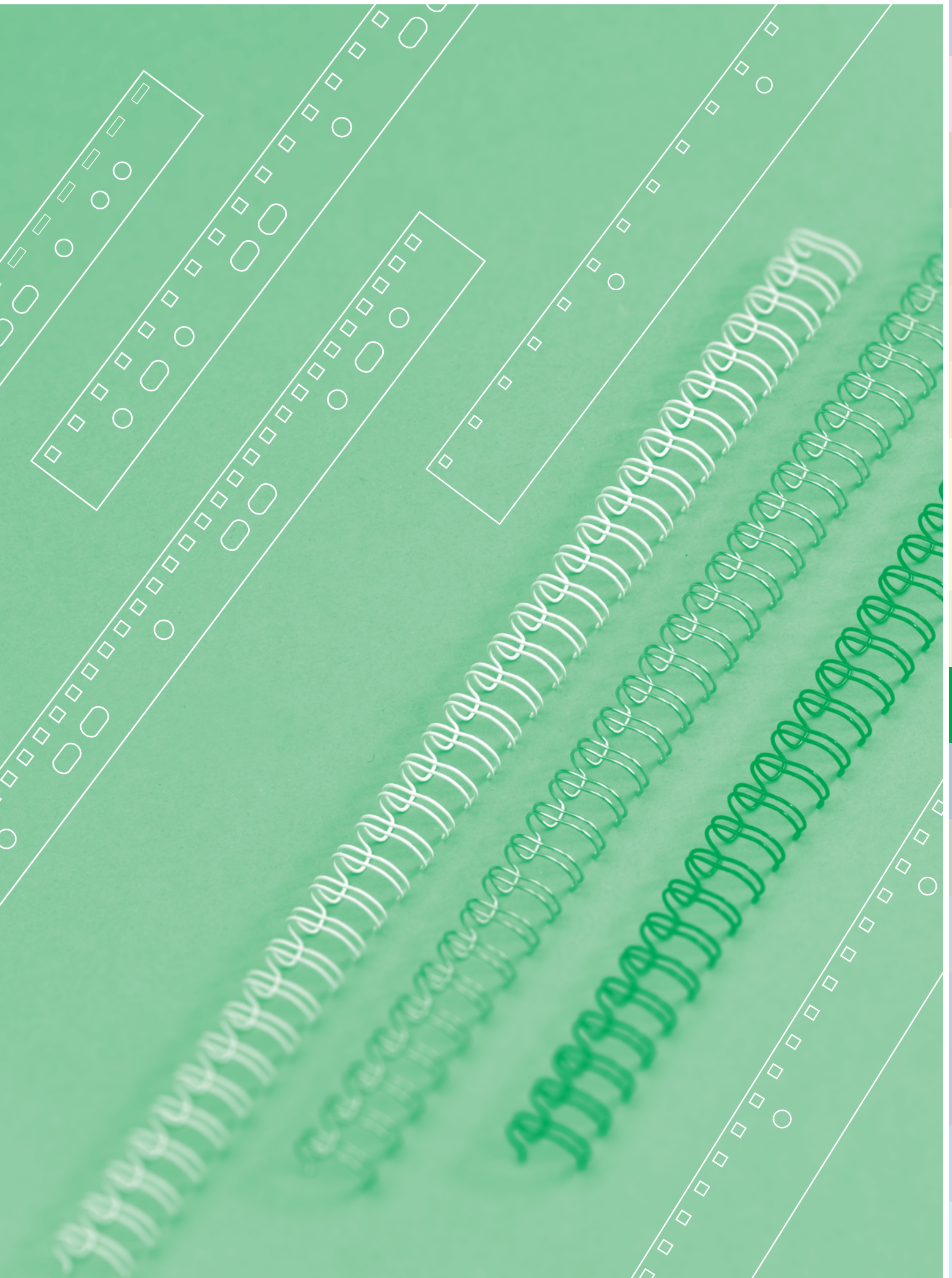



Binderücken & Zubehör

Wire bindings & accessories



Drahtbinderücken, für DIN A4, 3:1 Teilung

Wire bindings, for A4, 3:1 pitch

34 Schlaufen

34 loops

Artikel-Nr. Item no.	Durchmesser Diameter	Format Size	Farbe Colour
DB.31.3_16.01	5,5 mm	3 / 16"	☐ weiß white
DB.31.3_16.02	5,5 mm	3 / 16"	■ schwarz black
DB.31.3_16.04	5,5 mm	3 / 16"	■ blau blue
DB.31.3_16.06	5,5 mm	3 / 16"	■ silber (nc) silver (nc)
DB.31.1_4.01	6,9 mm	1 / 4"	☐ weiß white
DB.31.1_4.02	6,9 mm	1 / 4"	■ schwarz black
DB.31.1_4.04	6,9 mm	1 / 4"	■ blau blue
DB.31.1_4.06	6,9 mm	1 / 4"	■ silber (nc) silver (nc)
DB.31.5_16.01	8 mm	5 / 16"	☐ weiß white
DB.31.5_16.02	8 mm	5 / 16"	■ schwarz black
DB.31.5_16.04	8 mm	5 / 16"	■ blau blue
DB.31.5_16.06	8 mm	5 / 16"	■ silber (nc) silver (nc)
DB.31.3_8.01	9,5 mm	3 / 8"	☐ weiß white
DB.31.3_8.02	9,5 mm	3 / 8"	■ schwarz black
DB.31.3_8.04	9,5 mm	3 / 8"	■ blau blue
DB.31.3_8.06	9,5 mm	3 / 8"	■ silber (nc) silver (nc)
DB.31.7_16.01	11 mm	7 / 16"	☐ weiß white
DB.31.7_16.02	11 mm	7 / 16"	■ schwarz black
DB.31.7_16.04	11 mm	7 / 16"	■ blau blue
DB.31.7_16.06	11 mm	7 / 16"	■ silber (nc) silver (nc)
DB.31.1_2.01	12,7 mm	1 / 2"	☐ weiß white
DB.31.1_2.02	12,7 mm	1 / 2"	■ schwarz black
DB.31.1_2.04	12,7 mm	1 / 2"	■ blau blue
DB.31.1_2.06	12,7 mm	1 / 2"	■ silber (nc) silver (nc)
DB.31.9_16.01	14,3 mm	9 / 16"	☐ weiß white
DB.31.9_16.02	14,3 mm	9 / 16"	■ schwarz black
DB.31.9_16.04	14,3 mm	9 / 16"	■ blau blue
DB.31.9_16.06	14,3 mm	9 / 16"	■ silber (nc) silver (nc)
DB.31.5_8.01	16 mm	5 / 8"	☐ weiß white
DB.31.5_8.02	16 mm	5 / 8"	■ schwarz black
DB.31.5_8.04	16 mm	5 / 8"	■ blau blue
DB.31.5_8.06	16 mm	5 / 8"	■ silber (nc) silver (nc)

! Weitere Farben und Längen auf Anfrage | Additional colours and lengths on request



Binderücken & Zubehör

Wire bindings & accessories

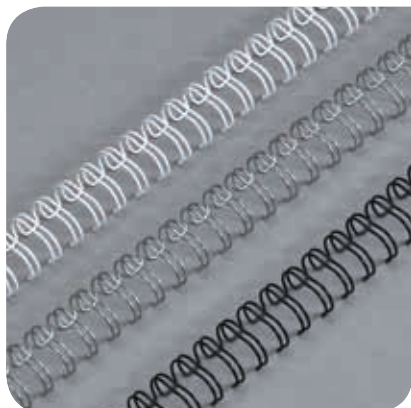

Drahtbinderücken, für DIN A5, 3:1 Teilung

Wire bindings, for A5, 3:1 pitch

24 Schlaufen

24 loops

Artikel-Nr. Item no.	Durchmesser Diameter	Format Size	Farbe Colour
DB.A5.31.3_16.01	5,5 mm	3 / 16"	☐ weiß white
DB.A5.31.3_16.02	5,5 mm	3 / 16"	■ schwarz black
DB.A5.31.3_16.06	5,5 mm	3 / 16"	■ silber (nc) silver (nc)
DB.A5.31.1_4.01	6,9 mm	1 / 4"	☐ weiß white
DB.A5.31.1_4.02	6,9 mm	1 / 4"	■ schwarz black
DB.A5.31.1_4.06	6,9 mm	1 / 4"	■ silber (nc) silver (nc)
DB.A5.31.5_16.01	8 mm	5 / 16"	☐ weiß white
DB.A5.31.5_16.02	8 mm	5 / 16"	■ schwarz black
DB.A5.31.5_16.06	8 mm	5 / 16"	■ silber (nc) silver (nc)
DB.A5.31.3_8.01	9,5 mm	3 / 8"	☐ weiß white
DB.A5.31.3_8.02	9,5 mm	3 / 8"	■ schwarz black
DB.A5.31.3_8.06	9,5 mm	3 / 8"	■ silber (nc) silver (nc)
DB.A5.31.7_16.01	11 mm	7 / 16"	☐ weiß white
DB.A5.31.7_16.02	11 mm	7 / 16"	■ schwarz black
DB.A5.31.7_16.06	11 mm	7 / 16"	■ silber (nc) silver (nc)
DB.A5.31.1_2.01	12,7 mm	1 / 2"	☐ weiß white
DB.A5.31.1_2.02	12,7 mm	1 / 2"	■ schwarz black
DB.A5.31.1_2.06	12,7 mm	1 / 2"	■ silber (nc) silver (nc)
DB.A5.31.9_16.01	14,3 mm	9 / 16"	☐ weiß white
DB.A5.31.9_16.02	14,3 mm	9 / 16"	■ schwarz black
DB.A5.31.9_16.06	14,3 mm	9 / 16"	■ silber (nc) silver (nc)
DB.A5.31.5_8.01	16 mm	5 / 8"	☐ weiß white
DB.A5.31.5_8.02	16 mm	5 / 8"	■ schwarz black
DB.A5.31.5_8.06	16 mm	5 / 8"	■ silber (nc) silver (nc)



Weitere Farben und Längen auf Anfrage | Additional colours and lengths on request



Binderücken & Zubehör

Wire bindings & accessories



Drahtbinderücken, für DIN A4, 2:1 Teilung

Wire bindings, for A4, 2:1 pitch

23 Schlaufen

23 loops

Artikel-Nr. Item no.	Durchmesser Diameter	Format Size	Farbe Colour
DB.21.1_4.01	6,9 mm	1 / 4"	<input type="checkbox"/> weiß white
DB.21.1_4.02	6,9 mm	1 / 4"	<input checked="" type="checkbox"/> schwarz black
DB.21.1_4.06	6,9 mm	1 / 4"	<input type="checkbox"/> silber (nc) silver (nc)
DB.21.5_16.01	8 mm	5 / 16"	<input type="checkbox"/> weiß white
DB.21.5_16.02	8 mm	5 / 16"	<input checked="" type="checkbox"/> schwarz black
DB.21.5_16.06	8 mm	5 / 16"	<input type="checkbox"/> silber (nc) silver (nc)
DB.21.3_8.01	9,5 mm	3 / 8"	<input type="checkbox"/> weiß white
DB.21.3_8.02	9,5 mm	3 / 8"	<input checked="" type="checkbox"/> schwarz black
DB.21.3_8.06	9,5 mm	3 / 8"	<input type="checkbox"/> silber (nc) silver (nc)
DB.21.7_16.01	11 mm	7 / 16"	<input type="checkbox"/> weiß white
DB.21.7_16.02	11 mm	7 / 16"	<input checked="" type="checkbox"/> schwarz black
DB.21.7_16.06	11 mm	7 / 16"	<input type="checkbox"/> silber (nc) silver (nc)
DB.21.1_2.01	12,7 mm	1 / 2"	<input type="checkbox"/> weiß white
DB.21.1_2.02	12,7 mm	1 / 2"	<input checked="" type="checkbox"/> schwarz black
DB.21.1_2.06	12,7 mm	1 / 2"	<input type="checkbox"/> silber (nc) silver (nc)
DB.21.9_16.01	14,3 mm	9 / 16"	<input type="checkbox"/> weiß white
DB.21.9_16.02	14,3 mm	9 / 16"	<input checked="" type="checkbox"/> schwarz black
DB.21.9_16.06	14,3 mm	9 / 16"	<input type="checkbox"/> silber (nc) silver (nc)
DB.21.5_8.01	16 mm	5 / 8"	<input type="checkbox"/> weiß white
DB.21.5_8.02	16 mm	5 / 8"	<input checked="" type="checkbox"/> schwarz black
DB.21.5_8.06	16 mm	5 / 8"	<input type="checkbox"/> silber (nc) silver (nc)
DB.21.3_4.01	19 mm	3 / 4"	<input type="checkbox"/> weiß white
DB.21.3_4.02	19 mm	3 / 4"	<input checked="" type="checkbox"/> schwarz black
DB.21.3_4.06	19 mm	3 / 4"	<input type="checkbox"/> silber (nc) silver (nc)
DB.21.7_8.01	22 mm	7 / 8"	<input type="checkbox"/> weiß white
DB.21.7_8.02	22 mm	7 / 8"	<input checked="" type="checkbox"/> schwarz black
DB.21.7_8.06	22 mm	7 / 8"	<input type="checkbox"/> silber (nc) silver (nc)
DB.21.1.01	25,4 mm	1"	<input type="checkbox"/> weiß white
DB.21.1.02	25,4 mm	1"	<input checked="" type="checkbox"/> schwarz black
DB.21.1.06	25,4 mm	1"	<input type="checkbox"/> silber (nc) silver (nc)
DB.21.11_4.01	32 mm	1 1 / 4"	<input type="checkbox"/> weiß white
DB.21.11_4.02	32 mm	1 1 / 4"	<input checked="" type="checkbox"/> schwarz black
DB.21.11_4.06	32 mm	1 1 / 4"	<input type="checkbox"/> silber (nc) silver (nc)

! Weitere Farben und Längen auf Anfrage | Additional colours and lengths on request



Binderücken & Zubehör

Wire bindings & accessories

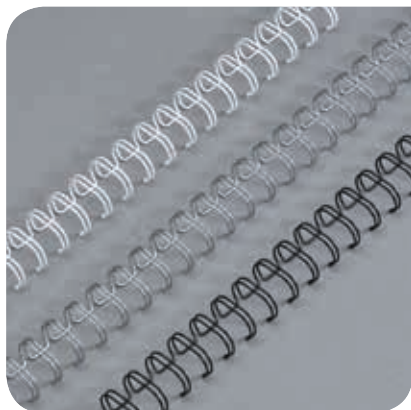

Drahtbinderücken, für DIN A5, 2:1 Teilung

Wire bindings, for A5, 2:1 pitch

16 Schlaufen

16 loops

Artikel-Nr. Item no.	Durchmesser Diameter	Format Size	Farbe Colour
DB.A5.21.5_8.01	16 mm	5 / 8"	<input type="checkbox"/> weiß white
DB.A5.21.5_8.02	16 mm	5 / 8"	<input checked="" type="checkbox"/> schwarz black
DB.A5.21.5_8.06	16 mm	5 / 8"	<input checked="" type="checkbox"/> silber (nc) silver (nc)
DB.A5.21.3_4.01	19 mm	3 / 4"	<input type="checkbox"/> weiß white
DB.A5.21.3_4.02	19 mm	3 / 4"	<input checked="" type="checkbox"/> schwarz black
DB.A5.21.3_4.06	19 mm	3 / 4"	<input checked="" type="checkbox"/> silber (nc) silver (nc)
DB.A5.21.7_8.01	22 mm	7 / 8"	<input type="checkbox"/> weiß white
DB.A5.21.7_8.02	22 mm	7 / 8"	<input checked="" type="checkbox"/> schwarz black
DB.A5.21.7_8.06	22 mm	7 / 8"	<input checked="" type="checkbox"/> silber (nc) silver (nc)
DB.A5.21.1.01	25,4 mm	1"	<input type="checkbox"/> weiß white
DB.A5.21.1.02	25,4 mm	1"	<input checked="" type="checkbox"/> schwarz black
DB.A5.21.1.06	25,4 mm	1"	<input checked="" type="checkbox"/> silber (nc) silver (nc)



Weitere Farben und Längen auf Anfrage | Additional colours and lengths on request



Binderücken & Zubehör

Wire bindings & accessories



Drahtbinderücken auf Spule, 3:1 Teilung

Wire bindings on spool, 3:1 pitch

für maschinelle Verarbeitung

for mechanical processing

Artikel-Nr. Item no.	Durchmesser Diameter	Format Size	Schlaufenanzahl Loops per spool	Farbe Colour
DB.31.3_16.S132.01	5,5 mm	3 / 16"	132.000	☐ weiß white
DB.31.3_16.S132.02	5,5 mm	3 / 16"	132.000	■ schwarz black
DB.31.3_16.S132.03	5,5 mm	3 / 16"	132.000	■ rot red
DB.31.3_16.S132.04	5,5 mm	3 / 16"	132.000	■ blau blue
DB.31.3_16.S132.06	5,5 mm	3 / 16"	132.000	■ silber (nc) silver (nc)
DB.31.1_4.S91.01	6,9 mm	1 / 4"	91.000	☐ weiß white
DB.31.1_4.S91.02	6,9 mm	1 / 4"	91.000	■ schwarz black
DB.31.1_4.S91.03	6,9 mm	1 / 4"	91.000	■ rot red
DB.31.1_4.S91.04	6,9 mm	1 / 4"	91.000	■ blau blue
DB.31.1_4.S91.06	6,9 mm	1 / 4"	91.000	■ silber (nc) silver (nc)
DB.31.5_16.S64.01	8 mm	5 / 16"	64.000	☐ weiß white
DB.31.5_16.S64.02	8 mm	5 / 16"	64.000	■ schwarz black
DB.31.5_16.S64.03	8 mm	5 / 16"	64.000	■ rot red
DB.31.5_16.S64.04	8 mm	5 / 16"	64.000	■ blau blue
DB.31.5_16.S64.06	8 mm	5 / 16"	64.000	■ silber (nc) silver (nc)
DB.31.3_8.S45.01	9,5 mm	3 / 8"	45.000	☐ weiß white
DB.31.3_8.S45.02	9,5 mm	3 / 8"	45.000	■ schwarz black
DB.31.3_8.S45.03	9,5 mm	3 / 8"	45.000	■ rot red
DB.31.3_8.S45.04	9,5 mm	3 / 8"	45.000	■ blau blue
DB.31.3_8.S45.06	9,5 mm	3 / 8"	45.000	■ silber (nc) silver (nc)
DB.31.7_16.S32.01	11 mm	7 / 16"	32.000	☐ weiß white
DB.31.7_16.S32.02	11 mm	7 / 16"	32.000	■ schwarz black
DB.31.7_16.S32.03	11 mm	7 / 16"	32.000	■ rot red
DB.31.7_16.S32.04	11 mm	7 / 16"	32.000	■ blau blue
DB.31.7_16.S32.06	11 mm	7 / 16"	32.000	■ silber (nc) silver (nc)
DB.31.1_2.S25.01	12,7 mm	1 / 2"	25.000	☐ weiß white
DB.31.1_2.S25.02	12,7 mm	1 / 2"	25.000	■ schwarz black
DB.31.1_2.S25.03	12,7 mm	1 / 2"	25.000	■ rot red
DB.31.1_2.S25.04	12,7 mm	1 / 2"	25.000	■ blau blue
DB.31.1_2.S25.06	12,7 mm	1 / 2"	25.000	■ silber (nc) silver (nc)
DB.31.9_16.S21.01	14,3 mm	9 / 16"	21.000	☐ weiß white
DB.31.9_16.S21.02	14,3 mm	9 / 16"	21.000	■ schwarz black
DB.31.9_16.S21.03	14,3 mm	9 / 16"	21.000	■ rot red
DB.31.9_16.S21.04	14,3 mm	9 / 16"	21.000	■ blau blue
DB.31.9_16.S21.06	14,3 mm	9 / 16"	21.000	■ silber (nc) silver (nc)

! Weitere Farben und Längen auf Anfrage | Additional colours and lengths on request



Binderücken & Zubehör

Wire bindings & accessories



Drahtbinderücken auf Spule, 2:1 Teilung

Wire bindings on spool, 2:1 pitch

für maschinelle Verarbeitung





for mechanical processing

Artikel-Nr. Item no.	Durchmesser Diameter	Format Size	Schlaufenanzahl Loops per spool	Farbe Colour
DB.21.5_8.S12.01	16 mm	5 / 8"	12.000	☐ weiß white
DB.21.5_8.S12.02	16 mm	5 / 8"	12.000	■ schwarz black
DB.21.5_8.S12.03	16 mm	5 / 8"	12.000	■ rot red
DB.21.5_8.S12.04	16 mm	5 / 8"	12.000	■ blau blue
DB.21.5_8.S12.06	16 mm	5 / 8"	12.000	■ silber (nc) silver (nc)
DB.21.3_4.S8.01	19 mm	3 / 4"	8.000	☐ weiß white
DB.21.3_4.S8.02	19 mm	3 / 4"	8.000	■ schwarz black
DB.21.3_4.S8.03	19 mm	3 / 4"	8.000	■ rot red
DB.21.3_4.S8.04	19 mm	3 / 4"	8.000	■ blau blue
DB.21.3_4.S8.06	19 mm	3 / 4"	8.000	■ silber (nc) silver (nc)
DB.21.7_8.S6.01	22 mm	7 / 8"	6.000	☐ weiß white
DB.21.7_8.S6.02	22 mm	7 / 8"	6.000	■ schwarz black
DB.21.7_8.S6.03	22 mm	7 / 8"	6.000	■ rot red
DB.21.7_8.S6.04	22 mm	7 / 8"	6.000	■ blau blue
DB.21.7_8.S6.06	22 mm	7 / 8"	6.000	■ silber (nc) silver (nc)
DB.21.1.S4_5.01	25,4 mm	1"	4.500	☐ weiß white
DB.21.1.S4_5.02	25,4 mm	1"	4.500	■ schwarz black
DB.21.1.S4_5.03	25,4 mm	1"	4.500	■ rot red
DB.21.1.S4_5.04	25,4 mm	1"	4.500	■ blau blue
DB.21.1.S4_5.06	25,4 mm	1"	4.500	■ silber (nc) silver (nc)
DB.21.11_4.2_7.01	32 mm	1 1 / 4"	2.700	☐ weiß white
DB.21.11_4.S2_7.02	32 mm	1 1 / 4"	2.700	■ schwarz black
DB.21.11_4.S2_7.06	32 mm	1 1 / 4"	2.700	■ silber (nc) silver (nc)



Drahtbinderücken nach Kundenwunsch

Wire bindings - customised

-  Mindestmenge: 1.000 Stück
minimum quantity: 100 pieces
-  möglich sowohl in 2:1 als auch in Teilung 3:1
available in 2:1 or 3:1 pitch
-  Sonderlängen auf die gewünschte Schlaufenanzahl abgelängt
cut-to-length with required number of loops
-  Sonderfarben, z.B. rot, blau, grün, etc.
special colours, e.g. red, blue, green, etc.



Binderücken & Zubehör

Wire bindings & accessories



Foliendeckblätter

Binding covers

für Draht- und Plastikbinderücken

for wire and plastic loop bindings

Artikel-Nr. Item no.	Format Size	Folienstärke Foil thickness
DB.DB.A5.HPVC015	DIN A5, 148 x 210 mm	Hart-PVC 0,15 mm, transparent rigid-PVC 150 micron, transparent
DB.DB.A5.HPVC020	DIN A5, 148 x 210 mm	Hart-PVC 0,20 mm, transparent rigid-PVC 200 micron, transparent
DB.DB.A5.HPVC030	DIN A5, 148 x 210 mm	Hart-PVC 0,30 mm, transparent rigid-PVC 300 micron, transparent
DB.DB.A5.PP030.MATT	DIN A5, 148 x 210 mm	PP-Folie 0,30 mm, matt-transparent PP foil 300 micron, frosted-transparent
DB.DB.A5.PP050.MATT	DIN A5, 148 x 210 mm	PP-Folie 0,50 mm, matt-transparent PP foil 500 micron, frosted-transparent
DB.DB.A5.PP080.MATT ²	DIN A5, 148 x 210 mm	PP-Folie 0,80 mm, matt-transparent PP foil 800 micron, frosted-transparent
DB.DB.A4.HPVC015 ¹	DIN A4, 210 x 297 mm	Hart-PVC 0,15 mm, transparent rigid-PVC 150 micron, transparent
DB.DB.A4.HPVC020	DIN A4, 210 x 297 mm	Hart-PVC 0,20 mm, transparent rigid-PVC 200 micron, transparent
DB.DB.A4.HPVC030	DIN A4, 210 x 297 mm	Hart-PVC 0,30 mm, transparent rigid-PVC 300 micron, transparent
DB.DB.A4.PP030.MATT	DIN A4, 210 x 297 mm	PP-Folie 0,30 mm, matt-transparent PP foil 300 micron, frosted-transparent
NEU DB.DB.A4.PP030.STR	DIN A4, 210 x 297 mm	PP-Folie 0,30 mm, matt-transparent, diagonal gestreift PP foil 300 micron, frosted-transparent, diagonal stripes
DB.DB.A4.PP050.MATT	DIN A4, 210 x 297 mm	PP-Folie 0,50 mm, matt-transparent PP foil 500 micron, frosted-transparent
DB.DB.A4.PP080.MATT	DIN A4, 210 x 297 mm	PP-Folie 0,80 mm, matt-transparent PP foil 800 micron, frosted-transparent
DB.DB.A3.HPVC020	DIN A3, 297 x 420 mm	Hart-PVC 0,20 mm, transparent rigid-PVC 200 micron, transparent
DB.DB.A3.HPVC030	DIN A3, 297 x 420 mm	Hart-PVC 0,30 mm, transparent rigid-PVC 300 micron, transparent
DB.DB.A3.PP030.MATT	DIN A3, 297 x 420 mm	PP-Folie 0,30 mm, matt-transparent PP foil 300 micron, frosted-transparent
DB.DB.A3.PP050.MATT	DIN A3, 297 x 420 mm	PP-Folie 0,50 mm, matt-transparent PP foil 500 micron, frosted-transparent
DB.DB.A2.HPVC020	DIN A2, 420 x 594 mm	Hart-PVC 0,20 mm, transparent rigid-PVC 200 micron, transparent

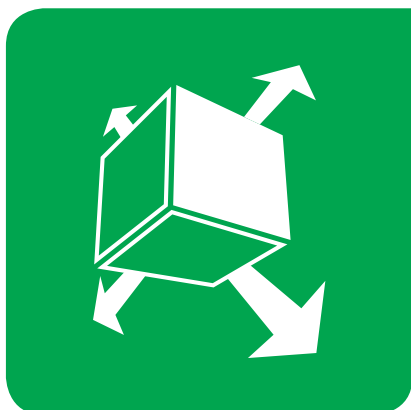

Foliendeckblätter / Zuschnitte nach Kundenwunsch

Binding covers - customised

-  Mindestmenge: 250 Stück
minimum quantity: 250 pieces
-  Sonderformate in fast jeder gewünschten Abmessung
custom-made in nearly all desired dimensions
-  verschiedene Folienstärken und Folienarten, z.B. Hart-PVC, PP, etc.
different foil thicknesses and foil types, e.g. PP, rigid PVC, etc.
-  verschiedene Folienfarben, z.B. glasklar, matt, transluzent oder farbig
different foil appearances, e.g. transparent, frosted, translucent or coloured
-  Aufdruck im Siebdruck, Offsetdruck oder mit (Blind)-Prägung
overprint by silk screen printing, offset printing or (blind) embossing
-  Verschiedene Stanzungen, z.B. gerundete Ecken, Lochung für Drahtbindung, Abheftlochung möglich
different press cuts available, e.g. rounded corners, filing holes for wire bindings, perforation



Binderücken & Zubehör

Wire bindings & accessories



Rückwände

Back covers

230 g / m² Karton weiß

230 g / m² white cardboard

Artikel-Nr. | Item no. Format | Size

DB.RW.A5 DIN A5, 148 x 210 mm

DB.RW.A4 DIN A4, 210 x 297 mm



Abheftstreifen für Draht- und Plastikbinderücken

Filing strips for wire and plastic loops binding

Hart-PVC

rigid-PVC

Artikel-Nr. Item no.	Format / Ausführung Size / Description	Folienstärke Foil thickness
DB.AS.A5.21.ECK ⁴	DIN A5, für Drahtbinderücken mit 2:1 Teilung (16 Schlaufen), eckige Löcher A5, for wire binding with 2:1 pitch (16 loops), squared holes	300 µm 300 micron
DB.AS.A5.31 ⁵	DIN A5, für Drahtbinderücken mit 3:1 Teilung (24 Schlaufen), eckige Löcher A5, for wire binding with 3:1 pitch (24 loops), squared holes	300 µm 300 micron
DB.AS.A4.21	DIN A4, für Drahtbinderücken mit 2:1 Teilung (23 Schlaufen), eckige Löcher A4, for wire binding with 2:1 pitch (23 loops), squared holes	300 µm 300 micron
DB.AS.A4.31.ECK ^{1,2}	DIN A4, für Drahtbinderücken mit 3:1 Teilung (34 Schlaufen), eckige Löcher A4, for wire binding with 3:1 pitch (34 loops), squared holes	300 µm 300 micron
DB.AS.A4.31.ECK.HPVC050	DIN A4, für Drahtbinderücken mit 3:1 Teilung, (34 Schlaufen) eckige Löcher A4, for wire binding with 3:1 pitch (34 loops), squared holes	500 µm 500 micron
DB.AS.A4.31.RUND ³	DIN A4, für Drahtbinderücken mit 3:1 Teilung, (34 Schlaufen) runde Löcher A4, for wire binding with 3:1 pitch (34 loops), round holes	300 µm 300 micron

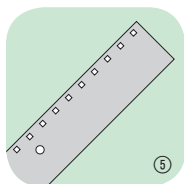
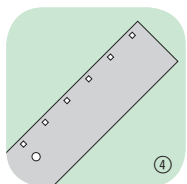
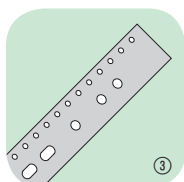
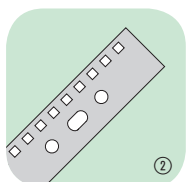



Buchsrauben & -ecken, Ringe, Ösen & Ketten

Binding screws, rings, eyelets & chains

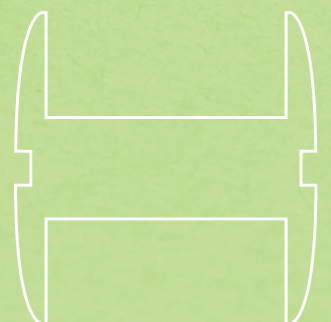
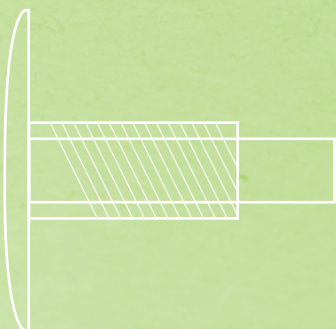
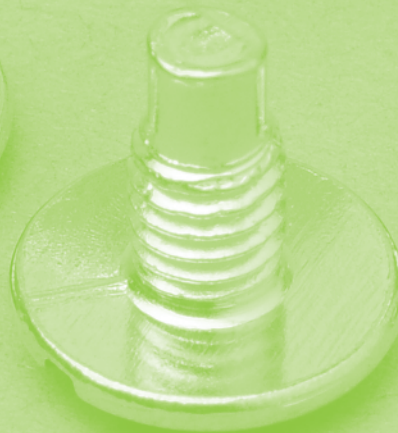
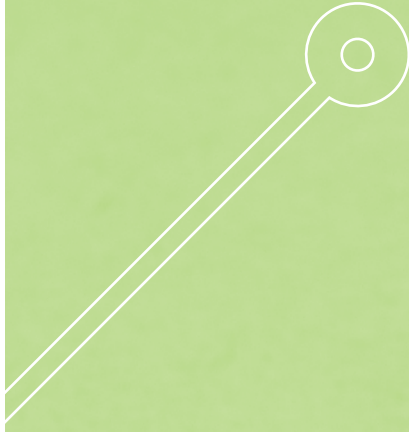
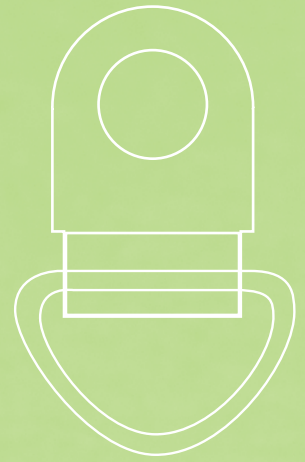
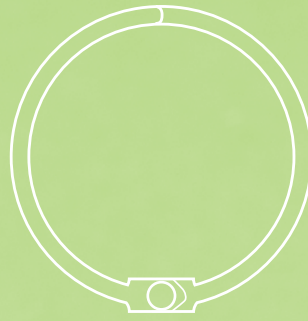
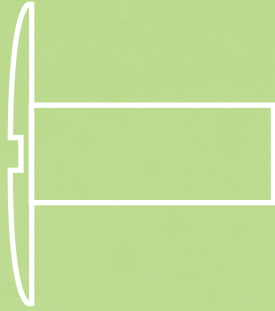



Buchschrauben & -ecken, Ringe, Ösen & Ketten

Binding screws, rings, eyelets & chains

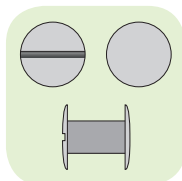
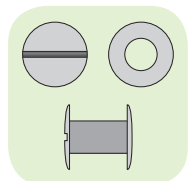

Buchschrauben, vernickelt

Binding screws, nickel-plated

10 mm Kopfdurchmesser, 5 mm Schaftdurchmesser

head diameter: 10 mm, shaft diameter: 5 mm

Artikel-Nr. Item no.	Schaftlänge Tube length	Ausführung Description
SET.BS.2.06	2 mm	Kopf der Hülsenmutter mit Loch, Kopf der Schraube geschlitzt tube with hole, screw with slotted head
SET.BS.3.06	3,5 mm	Kopf der Hülsenmutter mit Loch, Kopf der Schraube geschlitzt tube with hole, screw with slotted head
SET.BS.5.06 ³	5 mm	Kopf der Hülsenmutter und Kopf der Schraube geschlitzt screw and tube with slotted head
SET.BS.5.06.A ²	5 mm	Kopf der Hülsenmutter glatt, Kopf der Schraube geschlitzt tube with smooth head, screw with slotted head
SET.BS.6.06	6 mm	Kopf der Hülsenmutter glatt, Kopf der Schraube geschlitzt tube with smooth head, screw with slotted head
SET.BS.7.06 ¹	7 mm	Kopf der Hülsenmutter glatt, Kopf der Schraube geschlitzt tube with smooth head, screw with slotted head
SET.BS.8.06	8 mm	Kopf der Hülsenmutter glatt, Kopf der Schraube geschlitzt tube with smooth head, screw with slotted head
NEU SET.BS.9.06	9 mm	Kopf der Hülsenmutter glatt, Kopf der Schraube geschlitzt tube with smooth head, screw with slotted head
SET.BS.10.06	10 mm	Kopf der Hülsenmutter glatt, Kopf der Schraube geschlitzt tube with smooth head, screw with slotted head
SET.BS.12.06	12 mm	Kopf der Hülsenmutter glatt, Kopf der Schraube geschlitzt tube with smooth head, screw with slotted head
SET.BS.15.06	15 mm	Kopf der Hülsenmutter glatt, Kopf der Schraube geschlitzt tube with smooth head, screw with slotted head
SET.BS.20.06	20 mm	Kopf der Hülsenmutter glatt, Kopf der Schraube geschlitzt tube with smooth head, screw with slotted head
SET.BS.25.06	25 mm	Kopf der Hülsenmutter glatt, Kopf der Schraube geschlitzt tube with smooth head, screw with slotted head
SET.BS.30.06	30 mm	Kopf der Hülsenmutter glatt, Kopf der Schraube geschlitzt tube with smooth head, screw with slotted head
SET.BS.35.06	35 mm	Kopf der Hülsenmutter glatt, Kopf der Schraube geschlitzt tube with smooth head, screw with slotted head
SET.BS.40.06	40 mm	Kopf der Hülsenmutter glatt, Kopf der Schraube geschlitzt tube with smooth head, screw with slotted head
SET.BS.45.06	45 mm	Kopf der Hülsenmutter glatt, Kopf der Schraube geschlitzt tube with smooth head, screw with slotted head
SET.BS.50.06	50 mm	Kopf der Hülsenmutter glatt, Kopf der Schraube geschlitzt tube with smooth head, screw with slotted head
SET.BS.55.06	55 mm	Kopf der Hülsenmutter glatt, Kopf der Schraube geschlitzt tube with smooth head, screw with slotted head
SET.BS.60.06	60 mm	Kopf der Hülsenmutter glatt, Kopf der Schraube geschlitzt tube with smooth head, screw with slotted head
SET.BS.65.06	65 mm	Kopf der Hülsenmutter glatt, Kopf der Schraube geschlitzt tube with smooth head, screw with slotted head
SET.BS.70.06	70 mm	Kopf der Hülsenmutter glatt, Kopf der Schraube geschlitzt tube with smooth head, screw with slotted head
SET.BS.75.06	75 mm	Kopf der Hülsenmutter glatt, Kopf der Schraube geschlitzt tube with smooth head, screw with slotted head
SET.BS.80.06	80 mm	Kopf der Hülsenmutter glatt, Kopf der Schraube geschlitzt tube with smooth head, screw with slotted head
SET.BS.85.06	85 mm	Kopf der Hülsenmutter glatt, Kopf der Schraube geschlitzt tube with smooth head, screw with slotted head
SET.BS.90.06	90 mm	Kopf der Hülsenmutter glatt, Kopf der Schraube geschlitzt tube with smooth head, screw with slotted head
SET.BS.95.06	95 mm	Kopf der Hülsenmutter glatt, Kopf der Schraube geschlitzt tube with smooth head, screw with slotted head
SET.BS.100.06	100 mm	Kopf der Hülsenmutter glatt, Kopf der Schraube geschlitzt tube with smooth head, screw with slotted head
SET.BS.105.06	105 mm	Kopf der Hülsenmutter glatt, Kopf der Schraube geschlitzt tube with smooth head, screw with slotted head
SET.BS.110.06	110 mm	Kopf der Hülsenmutter glatt, Kopf der Schraube geschlitzt tube with smooth head, screw with slotted head
SET.BS.115.06	115 mm	Kopf der Hülsenmutter glatt, Kopf der Schraube geschlitzt tube with smooth head, screw with slotted head
SET.BS.120.06	120 mm	Kopf der Hülsenmutter glatt, Kopf der Schraube geschlitzt tube with smooth head, screw with slotted head
SET.BS.125.06	125 mm	Kopf der Hülsenmutter glatt, Kopf der Schraube geschlitzt tube with smooth head, screw with slotted head
SET.BS.130.06	130 mm	Kopf der Hülsenmutter glatt, Kopf der Schraube geschlitzt tube with smooth head, screw with slotted head
SET.BS.135.06	135 mm	Kopf der Hülsenmutter glatt, Kopf der Schraube geschlitzt tube with smooth head, screw with slotted head
SET.BS.140.06	140 mm	Kopf der Hülsenmutter glatt, Kopf der Schraube geschlitzt tube with smooth head, screw with slotted head
SET.BS.145.06	145 mm	Kopf der Hülsenmutter glatt, Kopf der Schraube geschlitzt tube with smooth head, screw with slotted head
SET.BS.150.06	150 mm	Kopf der Hülsenmutter glatt, Kopf der Schraube geschlitzt tube with smooth head, screw with slotted head



Buchschauben & -ecken, Ringe, Ösen & Ketten

Binding screws, rings, eyelets & chains

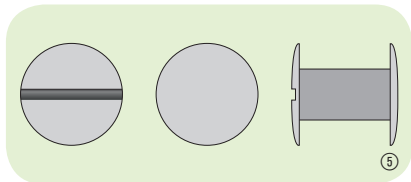
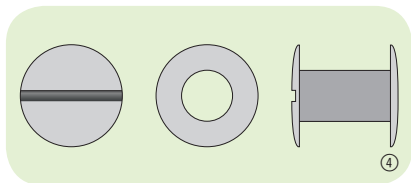
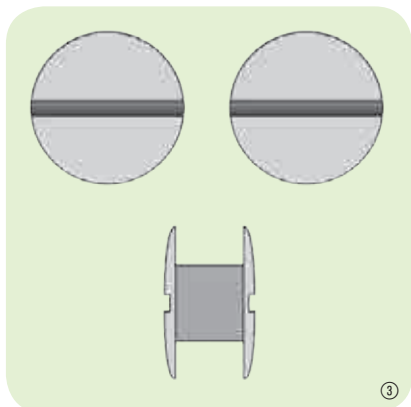

Buchschauben, vermessingt

Binding screws, brass-plated

10 mm Kopfdurchmesser, 5 mm Schaftdurchmesser

head diameter: 10 mm, shaft diameter: 5 mm



Artikel-Nr. Item no.	Schaftlänge Tube length	Ausführung Description
SET.BS.2.15	2 mm	Kopf der Hülsenmutter mit Loch, Kopf der Schraube geschlitzt tube with hole, screw with slotted head
SET.BS.3.15 ⁴	3,5 mm	Kopf der Hülsenmutter mit Loch, Kopf der Schraube geschlitzt tube with hole, screw with slotted head
SET.BS.5.15 ³	5 mm	Kopf der Hülsenmutter und Kopf der Schraube geschlitzt screw and tube with slotted head
SET.BS.5.15.A ⁵	5 mm	Kopf der Hülsenmutter glatt, Kopf der Schraube geschlitzt tube with smooth head, screw with slotted head
SET.BS.6.15 ¹	6 mm	Kopf der Hülsenmutter glatt, Kopf der Schraube geschlitzt tube with smooth head, screw with slotted head
SET.BS.7.15	7 mm	Kopf der Hülsenmutter glatt, Kopf der Schraube geschlitzt tube with smooth head, screw with slotted head
SET.BS.8.15 ²	8 mm	Kopf der Hülsenmutter glatt, Kopf der Schraube geschlitzt tube with smooth head, screw with slotted head
SET.BS.9.15	9 mm	Kopf der Hülsenmutter glatt, Kopf der Schraube geschlitzt tube with smooth head, screw with slotted head
SET.BS.10.15	10 mm	Kopf der Hülsenmutter glatt, Kopf der Schraube geschlitzt tube with smooth head, screw with slotted head
SET.BS.12.15	12 mm	Kopf der Hülsenmutter glatt, Kopf der Schraube geschlitzt tube with smooth head, screw with slotted head
SET.BS.15.15	15 mm	Kopf der Hülsenmutter glatt, Kopf der Schraube geschlitzt tube with smooth head, screw with slotted head
SET.BS.20.15	20 mm	Kopf der Hülsenmutter glatt, Kopf der Schraube geschlitzt tube with smooth head, screw with slotted head
SET.BS.25.15	25 mm	Kopf der Hülsenmutter glatt, Kopf der Schraube geschlitzt tube with smooth head, screw with slotted head
SET.BS.30.15	30 mm	Kopf der Hülsenmutter glatt, Kopf der Schraube geschlitzt tube with smooth head, screw with slotted head
SET.BS.35.15	35 mm	Kopf der Hülsenmutter glatt, Kopf der Schraube geschlitzt tube with smooth head, screw with slotted head
SET.BS.40.15	40 mm	Kopf der Hülsenmutter glatt, Kopf der Schraube geschlitzt tube with smooth head, screw with slotted head
SET.BS.45.15	45 mm	Kopf der Hülsenmutter glatt, Kopf der Schraube geschlitzt tube with smooth head, screw with slotted head
SET.BS.50.15	50 mm	Kopf der Hülsenmutter glatt, Kopf der Schraube geschlitzt tube with smooth head, screw with slotted head
SET.BS.55.15	55 mm	Kopf der Hülsenmutter glatt, Kopf der Schraube geschlitzt tube with smooth head, screw with slotted head
SET.BS.60.15	60 mm	Kopf der Hülsenmutter glatt, Kopf der Schraube geschlitzt tube with smooth head, screw with slotted head
SET.BS.65.15	65 mm	Kopf der Hülsenmutter glatt, Kopf der Schraube geschlitzt tube with smooth head, screw with slotted head
SET.BS.70.15	70 mm	Kopf der Hülsenmutter glatt, Kopf der Schraube geschlitzt tube with smooth head, screw with slotted head
SET.BS.75.15	75 mm	Kopf der Hülsenmutter glatt, Kopf der Schraube geschlitzt tube with smooth head, screw with slotted head
SET.BS.80.15	80 mm	Kopf der Hülsenmutter glatt, Kopf der Schraube geschlitzt tube with smooth head, screw with slotted head
SET.BS.85.15	85 mm	Kopf der Hülsenmutter glatt, Kopf der Schraube geschlitzt tube with smooth head, screw with slotted head
SET.BS.90.15	90 mm	Kopf der Hülsenmutter glatt, Kopf der Schraube geschlitzt tube with smooth head, screw with slotted head
SET.BS.95.15	95 mm	Kopf der Hülsenmutter glatt, Kopf der Schraube geschlitzt tube with smooth head, screw with slotted head
SET.BS.100.15	100 mm	Kopf der Hülsenmutter glatt, Kopf der Schraube geschlitzt tube with smooth head, screw with slotted head
SET.BS.105.15	105 mm	Kopf der Hülsenmutter glatt, Kopf der Schraube geschlitzt tube with smooth head, screw with slotted head
SET.BS.110.15	110 mm	Kopf der Hülsenmutter glatt, Kopf der Schraube geschlitzt tube with smooth head, screw with slotted head
SET.BS.115.15	115 mm	Kopf der Hülsenmutter glatt, Kopf der Schraube geschlitzt tube with smooth head, screw with slotted head
SET.BS.120.15	120 mm	Kopf der Hülsenmutter glatt, Kopf der Schraube geschlitzt tube with smooth head, screw with slotted head
SET.BS.125.15	125 mm	Kopf der Hülsenmutter glatt, Kopf der Schraube geschlitzt tube with smooth head, screw with slotted head
SET.BS.130.15	130 mm	Kopf der Hülsenmutter glatt, Kopf der Schraube geschlitzt tube with smooth head, screw with slotted head
SET.BS.135.15	135 mm	Kopf der Hülsenmutter glatt, Kopf der Schraube geschlitzt tube with smooth head, screw with slotted head
SET.BS.140.15	140 mm	Kopf der Hülsenmutter glatt, Kopf der Schraube geschlitzt tube with smooth head, screw with slotted head
SET.BS.145.15	145 mm	Kopf der Hülsenmutter glatt, Kopf der Schraube geschlitzt tube with smooth head, screw with slotted head
SET.BS.150.15	150 mm	Kopf der Hülsenmutter glatt, Kopf der Schraube geschlitzt tube with smooth head, screw with slotted head



Buchschrauben & -ecken, Ringe, Ösen & Ketten

Binding screws, rings, eyelets & chains

NEU
now in stock



Buchschrauben, verkupfert

Binding screws, copper-plated

10 mm Kopfdurchmesser, 5 mm Schaftdurchmesser
head diameter: 10 mm, shaft diameter: 5 mm

Artikel-Nr. Item no.	Schaftlänge Tube length	Ausführung Description
SET.BS.2.19	2 mm	Kopf der Hülsenmutter glatt, Kopf der Schraube geschlitzt tube with smooth head, screw with slotted head
SET.BS.3.19	3,5 mm	Kopf der Hülsenmutter glatt, Kopf der Schraube geschlitzt tube with smooth head, screw with slotted head
SET.BS.5.19	5 mm	Kopf der Hülsenmutter glatt, Kopf der Schraube geschlitzt tube with smooth head, screw with slotted head
SET.BS.6.19	6 mm	Kopf der Hülsenmutter glatt, Kopf der Schraube geschlitzt tube with smooth head, screw with slotted head
SET.BS.8.19	8 mm	Kopf der Hülsenmutter glatt, Kopf der Schraube geschlitzt tube with smooth head, screw with slotted head
SET.BS.10.19 ¹	10 mm	Kopf der Hülsenmutter glatt, Kopf der Schraube geschlitzt tube with smooth head, screw with slotted head
SET.BS.12.19	12 mm	Kopf der Hülsenmutter glatt, Kopf der Schraube geschlitzt tube with smooth head, screw with slotted head
SET.BS.15.19	15 mm	Kopf der Hülsenmutter glatt, Kopf der Schraube geschlitzt tube with smooth head, screw with slotted head
SET.BS.20.19	20 mm	Kopf der Hülsenmutter glatt, Kopf der Schraube geschlitzt tube with smooth head, screw with slotted head
SET.BS.25.19	25 mm	Kopf der Hülsenmutter glatt, Kopf der Schraube geschlitzt tube with smooth head, screw with slotted head



Buchschrauben, schwarz verzinkt

Binding screws, black zinc-plated

10 mm Kopfdurchmesser, 5 mm Schaftdurchmesser
head diameter: 10 mm, shaft diameter: 5 mm

Artikel-Nr. Item no.	Schaftlänge Tube length	Ausführung Description
SET.BS.45.02 ¹	45 mm	Kopf der Hülsenmutter glatt, Kopf der Schraube geschlitzt tube with smooth head, screw with slotted head
SET.BS.50.02	50 mm	Kopf der Hülsenmutter glatt, Kopf der Schraube geschlitzt tube with smooth head, screw with slotted head
SET.BS.55.02	55 mm	Kopf der Hülsenmutter glatt, Kopf der Schraube geschlitzt tube with smooth head, screw with slotted head
SET.BS.60.02	60 mm	Kopf der Hülsenmutter glatt, Kopf der Schraube geschlitzt tube with smooth head, screw with slotted head

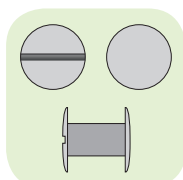

Verlängerungen für Buchschrauben

Extensions for binding-screws

zum Vergrößern der Schafthöhe, Schaftdurchmesser 5 mm
to enlarge the tube length, shaft diameter 5 mm

Artikel-Nr Item no.	Schaftlänge Tube length	Farbe Colour
BS.V10.06	10 mm	■ vernickelt nickel-plated
BS.V15.06	15 mm	■ vernickelt nickel-plated
BS.V20.06	20 mm	■ vernickelt nickel-plated
BS.V25.06	25 mm	■ vernickelt nickel-plated
BS.V30.06	30 mm	■ vernickelt nickel-plated



Buchschrauben & -ecken, Ringe, Ösen & Ketten

Binding screws, rings, eyelets & chains

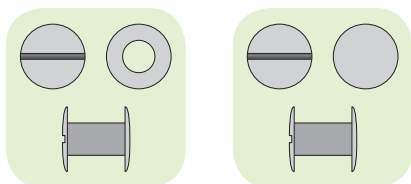

Buchschrauben, Kopf schwarz lackiert

Binding screws, black painted head

10 mm Kopfdurchmesser, 5 mm Schaftdurchmesser

head diameter: 10 mm, shaft diameter: 5 mm

Artikel-Nr. Item no.	Schaftlänge Tube length	Ausführung Description
SET.BS.2.02	2 mm	Kopf der Hülsenmutter mit Loch, Kopf der Schraube geschlitzt tube with hole, screw with slotted head
SET.BS.3.02	3,5 mm	Kopf der Hülsenmutter mit Loch, Kopf der Schraube geschlitzt tube with hole, screw with slotted head
SET.BS.5.02 ¹	5 mm	Kopf der Hülsenmutter glatt, Kopf der Schraube geschlitzt female tube and slotted male screw
SET.BS.6.02	6 mm	Kopf der Hülsenmutter glatt, Kopf der Schraube geschlitzt tube with smooth head, screw with slotted head
SET.BS.7.02	7 mm	Kopf der Hülsenmutter glatt, Kopf der Schraube geschlitzt tube with smooth head, screw with slotted head
SET.BS.8.02	8 mm	Kopf der Hülsenmutter glatt, Kopf der Schraube geschlitzt tube with smooth head, screw with slotted head
SET.BS.10.02	10 mm	Kopf der Hülsenmutter glatt, Kopf der Schraube geschlitzt tube with smooth head, screw with slotted head
SET.BS.15.02	15 mm	Kopf der Hülsenmutter glatt, Kopf der Schraube geschlitzt tube with smooth head, screw with slotted head
SET.BS.20.02	20 mm	Kopf der Hülsenmutter glatt, Kopf der Schraube geschlitzt tube with smooth head, screw with slotted head
SET.BS.25.02	25 mm	Kopf der Hülsenmutter glatt, Kopf der Schraube geschlitzt tube with smooth head, screw with slotted head
SET.BS.30.02	30 mm	Kopf der Hülsenmutter glatt, Kopf der Schraube geschlitzt tube with smooth head, screw with slotted head
SET.BS.35.02	35 mm	Kopf der Hülsenmutter glatt, Kopf der Schraube geschlitzt tube with smooth head, screw with slotted head
SET.BS.40.02	40 mm	Kopf der Hülsenmutter glatt, Kopf der Schraube geschlitzt tube with smooth head, screw with slotted head



Buchschrauben mit Rosettenscheibe

Binding screws with rosette disc

Hülse mit 10 mm Kopfdurchmesser und 5 mm Schaftdurchmesser,

Senkkopfschraube mit 8 mm Kopfdurchmesser und 3 mm Länge

Rosettenscheibe mit 6 mm Innendurchmesser, 13 mm Außendurchmesser und 2,3 mm Höhe

Tube: Head diameter: 10 mm, shaft diameter: 5 mm

Countersunk screw: Head diameter: 8 mm, length: 3 mm

Rosette discs: Inner diameter: 6 mm, outer diameter: 13 mm, height: 2.33 mm

NEU
now in stock

Artikel-Nr. Item no.	Schaftlänge Tube length	Ausführung Description
SET.BS.2.SK_RS.06	2 mm	Hülsenkopf mit Loch, Senkkopfschraube aus Edelstahl mit Innensechskant tube with hole, countersunk screw with internal hex, made of stainless steel
SET.BS.3_5.SK_RS.06	3,5 mm	Hülsenkopf mit Loch, Senkkopfschraube aus Edelstahl mit Innensechskant tube with hole, countersunk screw with internal hex, made of stainless steel
SET.BS.5.SK_RS.06	5 mm	Hülsenkopf glatt, Senkkopfschraube aus Edelstahl mit Innensechskant tube with smooth head, countersunk screw with internal hex, made of stainless steel
SET.BS.6.SK_RS.06	6 mm	Hülsenkopf glatt, Senkkopfschraube aus Edelstahl mit Innensechskant tube with smooth head, countersunk screw with internal hex, made of stainless steel
SET.BS.7.SK_RS.06	7 mm	Hülsenkopf glatt, Senkkopfschraube aus Edelstahl mit Innensechskant tube with smooth head, countersunk screw with internal hex, made of stainless steel
SET.BS.8.SK_RS.06 ¹	8 mm	Hülsenkopf glatt, Senkkopfschraube aus Edelstahl mit Innensechskant tube with smooth head, countersunk screw with internal hex, made of stainless steel
SET.BS.9.SK_RS.06	9 mm	Hülsenkopf glatt, Senkkopfschraube aus Edelstahl mit Innensechskant tube with smooth head, countersunk screw with internal hex, made of stainless steel
SET.BS.10.SK_RS.06	10 mm	Hülsenkopf glatt, Senkkopfschraube aus Edelstahl mit Innensechskant tube with smooth head, countersunk screw with internal hex, made of stainless steel
SET.BS.12.SK_RS.06	12 mm	Hülsenkopf glatt, Senkkopfschraube aus Edelstahl mit Innensechskant tube with smooth head, countersunk screw with internal hex, made of stainless steel
SET.BS.15.SK_RS.06	15 mm	Hülsenkopf glatt, Senkkopfschraube aus Edelstahl mit Innensechskant tube with smooth head, countersunk screw with internal hex, made of stainless steel

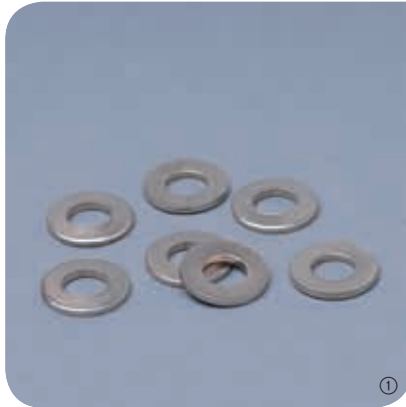

Unterlegscheiben

Washers

1 mm stark, zur Anpassung der Schafthöhe

1 mm thick, to adjust the filling level

Artikel-Nr. Item no.	Durchmesser Diameter	Ausführung Description	Farbe Colour
BS.U10.06 ¹	10 mm		■ vernickelt nickel-plated
BS.U10.15	10 mm		■ vermessingt brass-plated
BS.U15.06	15 mm		■ vernickelt nickel-plated
BS.U15.15	15 mm		■ vermessingt brass-plated
BS.U17.V.06 ²	17 mm	mit Vertiefung with recess	■ vernickelt nickel-plated
BS.U17.V.15	17 mm	mit Vertiefung with recess	■ vermessingt brass-plated

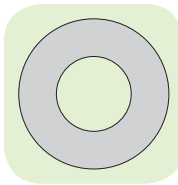

Abdeckkappen für Buchsrauben

Cover caps for binding screws

10 mm Kopfdurchmesser, 5 mm Schaftdurchmesser

head diameter: 10 mm, shaft diameter: 5 mm

Artikel-Nr. Item no.	Ausführung Description	Farbe Colour
BS.A.01 ¹	2-teilig (Abdeckkappe und Unterlegscheibe) 2 pcs (cover cap and washer)	□ weiß white
BS.A.02	2-teilig (Abdeckkappe und Unterlegscheibe) 2 pcs (cover cap and washer)	■ schwarz black



Trageschlaufen

Swatch straps

zum Einbinden in Buchsrauben

for integrating into binding screws

Artikel-Nr. Item no.	Länge Length	Farbe Colour
BS.SCHL.95.01 ¹	95 mm	□ weiß white
BS.SCHL.95.02	95 mm	■ schwarz black
BS.SCHL.135.01	135 mm	□ weiß white
BS.SCHL.135.02	135 mm	■ schwarz black





Buchschauben & -ecken, Ringe, Ösen & Ketten

Binding screws, rings, eyelets & chains

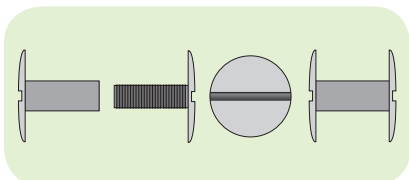

Kunststoffbuchschauben

Plastic binding screws

12 mm Kopfdurchmesser, 5 mm Schaftdurchmesser

head diameter: 12 mm, shaft diameter: 5 mm

Artikel-Nr. Item no.	Schafthöhe Tube length	Farbe Colour	Ausführung Description
NEU BS.KU.3_5.00	3,5 mm	☐ transparent transparent	Kopf der Hülsenmutter und Kopf der Schraube geschlitzt screw and tube with slotted head
BS.KU.3_5.01	3,5 mm	☐ weiß white	Kopf der Hülsenmutter und Kopf der Schraube geschlitzt screw and tube with slotted head
BS.KU.3_5.02	3,5 mm	■ schwarz black	Kopf der Hülsenmutter und Kopf der Schraube geschlitzt screw and tube with slotted head
NEU BS.KU.5.00	5 mm	☐ transparent transparent	Kopf der Hülsenmutter und Kopf der Schraube geschlitzt screw and tube with slotted head
BS.KU.5.01	5 mm	☐ weiß white	Kopf der Hülsenmutter und Kopf der Schraube geschlitzt screw and tube with slotted head
BS.KU.5.02	5 mm	■ schwarz black	Kopf der Hülsenmutter und Kopf der Schraube geschlitzt screw and tube with slotted head
BS.KU.6.01	6 mm	☐ weiß white	Kopf der Hülsenmutter und Kopf der Schraube geschlitzt screw and tube with slotted head
BS.KU.6.02	6 mm	■ schwarz black	Kopf der Hülsenmutter und Kopf der Schraube geschlitzt screw and tube with slotted head
BS.KU.7.01	7 mm	☐ weiß white	Kopf der Hülsenmutter und Kopf der Schraube geschlitzt screw and tube with slotted head
BS.KU.7.02	7 mm	■ schwarz black	Kopf der Hülsenmutter und Kopf der Schraube geschlitzt screw and tube with slotted head
BS.KU.8.01	8 mm	☐ weiß white	Kopf der Hülsenmutter und Kopf der Schraube geschlitzt screw and tube with slotted head
BS.KU.8.02	8 mm	■ schwarz black	Kopf der Hülsenmutter und Kopf der Schraube geschlitzt screw and tube with slotted head
NEU BS.KU.10.00 ²	10 mm	☐ transparent transparent	Kopf der Hülsenmutter und Kopf der Schraube geschlitzt screw and tube with slotted head
BS.KU.10.01	10 mm	☐ weiß white	Kopf der Hülsenmutter und Kopf der Schraube geschlitzt screw and tube with slotted head
BS.KU.10.02 ³	10 mm	■ schwarz black	Kopf der Hülsenmutter und Kopf der Schraube geschlitzt screw and tube with slotted head
BS.KU.12.01	12 mm	☐ weiß white	Kopf der Hülsenmutter und Kopf der Schraube geschlitzt screw and tube with slotted head
BS.KU.12.02	12 mm	■ schwarz black	Kopf der Hülsenmutter und Kopf der Schraube geschlitzt screw and tube with slotted head
BS.KU.13.01	13 mm	☐ weiß white	Kopf der Hülsenmutter und Kopf der Schraube geschlitzt screw and tube with slotted head
BS.KU.13.02	13 mm	■ schwarz black	Kopf der Hülsenmutter und Kopf der Schraube geschlitzt screw and tube with slotted head
NEU BS.KU.15.00	15 mm	☐ transparent transparent	Kopf der Hülsenmutter und Kopf der Schraube geschlitzt screw and tube with slotted head
BS.KU.15.01	15 mm	☐ weiß white	Kopf der Hülsenmutter und Kopf der Schraube geschlitzt screw and tube with slotted head
BS.KU.15.02	15 mm	■ schwarz black	Kopf der Hülsenmutter und Kopf der Schraube geschlitzt screw and tube with slotted head
BS.KU.16.01	16 mm	☐ weiß white	Kopf der Hülsenmutter und Kopf der Schraube geschlitzt screw and tube with slotted head
BS.KU.16.02	16 mm	■ schwarz black	Kopf der Hülsenmutter und Kopf der Schraube geschlitzt screw and tube with slotted head
NEU BS.KU.20.00	20 mm	☐ transparent transparent	Kopf der Hülsenmutter und Kopf der Schraube geschlitzt screw and tube with slotted head
BS.KU.20.01	20 mm	☐ weiß white	Kopf der Hülsenmutter und Kopf der Schraube geschlitzt screw and tube with slotted head
BS.KU.20.02	20 mm	■ schwarz black	Kopf der Hülsenmutter und Kopf der Schraube geschlitzt screw and tube with slotted head
NEU BS.KU.25.00 ⁴	25 mm	☐ transparent transparent	Kopf der Hülsenmutter und Kopf der Schraube geschlitzt screw and tube with slotted head
BS.KU.25.01	25 mm	☐ weiß white	Kopf der Hülsenmutter und Kopf der Schraube geschlitzt screw and tube with slotted head
BS.KU.25.02	25 mm	■ schwarz black	Kopf der Hülsenmutter und Kopf der Schraube geschlitzt screw and tube with slotted head
NEU BS.KU.30.00	30 mm	☐ transparent transparent	Kopf der Hülsenmutter und Kopf der Schraube geschlitzt screw and tube with slotted head
BS.KU.30.01	30 mm	☐ weiß white	Kopf der Hülsenmutter und Kopf der Schraube geschlitzt screw and tube with slotted head
BS.KU.30.02	30 mm	■ schwarz black	Kopf der Hülsenmutter und Kopf der Schraube geschlitzt screw and tube with slotted head
BS.KU.35.01 ¹	35 mm	☐ weiß white	Kopf der Hülsenmutter und Kopf der Schraube geschlitzt screw and tube with slotted head
BS.KU.35.02	35 mm	■ schwarz black	Kopf der Hülsenmutter und Kopf der Schraube geschlitzt screw and tube with slotted head
BS.KU.40.01	40 mm	☐ weiß white	Kopf der Hülsenmutter und Kopf der Schraube geschlitzt screw and tube with slotted head
BS.KU.40.02	40 mm	■ schwarz black	Kopf der Hülsenmutter und Kopf der Schraube geschlitzt screw and tube with slotted head
BS.KU.45.01	45 mm	☐ weiß white	Kopf der Hülsenmutter und Kopf der Schraube geschlitzt screw and tube with slotted head
BS.KU.45.02	45 mm	■ schwarz black	Kopf der Hülsenmutter und Kopf der Schraube geschlitzt screw and tube with slotted head
BS.KU.50.01	50 mm	☐ weiß white	Kopf der Hülsenmutter und Kopf der Schraube geschlitzt screw and tube with slotted head
BS.KU.50.02	50 mm	■ schwarz black	Kopf der Hülsenmutter und Kopf der Schraube geschlitzt screw and tube with slotted head
BS.KU.60.01	60 mm	☐ weiß white	Kopf der Hülsenmutter und Kopf der Schraube geschlitzt screw and tube with slotted head
BS.KU.60.02	60 mm	■ schwarz black	Kopf der Hülsenmutter und Kopf der Schraube geschlitzt screw and tube with slotted head
BS.KU.80.01	80 mm	☐ weiß white	Kopf der Hülsenmutter und Kopf der Schraube geschlitzt screw and tube with slotted head
BS.KU.80.02	80 mm	■ schwarz black	Kopf der Hülsenmutter und Kopf der Schraube geschlitzt screw and tube with slotted head
BS.KU.90.01	90 mm	☐ weiß white	Kopf der Hülsenmutter und Kopf der Schraube geschlitzt screw and tube with slotted head
BS.KU.90.02	90 mm	■ schwarz black	Kopf der Hülsenmutter und Kopf der Schraube geschlitzt screw and tube with slotted head



Buchschrauben & -ecken, Ringe, Ösen & Ketten

Binding screws, rings, eyelets & chains

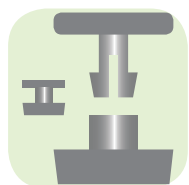

Druckösen

Snap studs

Kunststoff, 2-teilig

plastic, two-pieces

Artikel-Nr. Item no.	Füllhöhe / Ausführung Filling level	Farbe Colour
DOE.1_5.00	1,5 mm (dünn) (thin)	☐ transparent transparent
DOE.1_5.01	1,5 mm (dünn) (thin)	☐ weiß white
DOE.1_5.02	1,5 mm (dünn) (thin)	■ schwarz black
DOE.2_5.00	2,5 mm (dünn) (thin)	☐ transparent transparent
DOE.2_5.01 ³	2,5 mm (dünn) (thin)	☐ weiß white
DOE.2_5.02	2,5 mm (dünn) (thin)	■ schwarz black
DOE.2_5D.00	2,5 mm	☐ transparent transparent
DOE.2_5D.01	2,5 mm	☐ weiß white
DOE.3D.00 ¹	3 mm	☐ transparent transparent
DOE.3D.01	3 mm	☐ weiß white
DOE.3D.02	3 mm	■ schwarz black
DOE.3_5.00	3,5 mm (dünn) (thin)	☐ transparent transparent
DOE.3_5.01	3,5 mm (dünn) (thin)	☐ weiß white
DOE.3_5.02	3,5 mm (dünn) (thin)	■ schwarz black
DOE.L.3.00	0-3 mm (mit Loch) (with hole)	☐ transparent transparent
DOE.5D.00	5 mm	☐ transparent transparent
DOE.5D.01	5 mm	☐ weiß white
DOE.5D.02	5 mm	■ schwarz black
DOE.L.6.00	0-6 mm (mit Loch) (with hole)	☐ transparent transparent
DOE.7_5D.01	7,5 mm	☐ weiß white
DOE.7_5D.02 ²	7,5 mm	■ schwarz black
DOE.L.9.00	0-9 mm (mit Loch) (with hole)	☐ transparent transparent
DOE.10D.01	10 mm	☐ weiß white
DOE.10D.02	10 mm	■ schwarz black

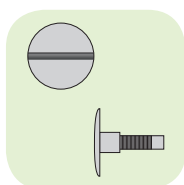
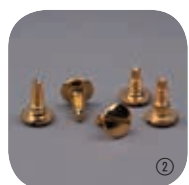

Spezialschrauben

Extension screw tops

mit Schlitz, zur Anpassung der Schafthöhe

with slot, to adjust the shaft length

Artikel-Nr. Item no.	Ausführung Description	Farbe Colour
BS.S7_5.1.06	1 mm Verlängerung 1 mm extension	■ vernickelt nickel-plated
BS.S7_5.1.15	1 mm Verlängerung 1 mm extension	■ vermessingt brass-plated
BS.S7_5.2.06	2 mm Verlängerung 2 mm extension	■ vernickelt nickel-plated
BS.S7_5.2.15	2 mm Verlängerung 2 mm extension	■ vermessingt brass-plated
BS.S7_5.3.06	3 mm Verlängerung 3 mm extension	■ vernickelt nickel-plated
BS.S7_5.3.15	3 mm Verlängerung 3 mm extension	■ vermessingt brass-plated
BS.S7_5.4.06 ¹	4 mm Verlängerung 4 mm extension	■ vernickelt nickel-plated
BS.S7_5.4.15 ²	4 mm Verlängerung 4 mm extension	■ vermessingt brass-plated



Buchschrauben & -ecken, Ringe, Ösen & Ketten

Binding screws, rings, eyelets & chains



①

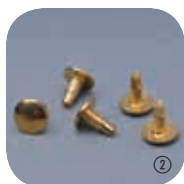

②

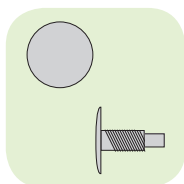

Einpressköpfe für Buchschrauben

Hammer tops for binding screws

8 mm lang, zum Einschlagen

length 8 mm, to hammer in

Artikel-Nr. | Item no. Farbe | Colour

BS.E8.06 ¹ ■ vernickelt | nickel-plated

BS.E8.15 ² ■ vermessingt | brass-plated



①



②

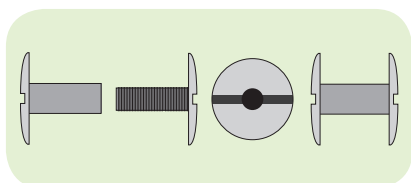

Kunststoffbuchschrauben mit Loch

Plastic binding screws with hole

12 mm Kopfdurchmesser, ca. 6 mm Schaftdurchmesser

head diameter: 12 mm, shaft diameter: 6 mm

Artikel-Nr. | Item no. Schaftlänge | Tube length Farbe | Colour

BS.D.3_5.01 3,5 mm □ weiß | white

BS.D.3_5.02 3,5 mm ■ schwarz | black

BS.D.5.01 ² 5 mm □ weiß | white

BS.D.5.02 5 mm ■ schwarz | black

BS.D.10.01 10 mm □ weiß | white

BS.D.10.02 10 mm ■ schwarz | black

BS.D.15.01 15 mm □ weiß | white

BS.D.15.02 15 mm ■ schwarz | black

BS.D.20.01 20 mm □ weiß | white

BS.D.20.02 ¹ 20 mm ■ schwarz | black

BS.D.30.01 30 mm □ weiß | white

BS.D.30.02 30 mm ■ schwarz | black

BS.D.40.01 40 mm □ weiß | white

BS.D.40.02 40 mm ■ schwarz | black

BS.D.50.01 50 mm □ weiß | white

BS.D.50.02 50 mm ■ schwarz | black

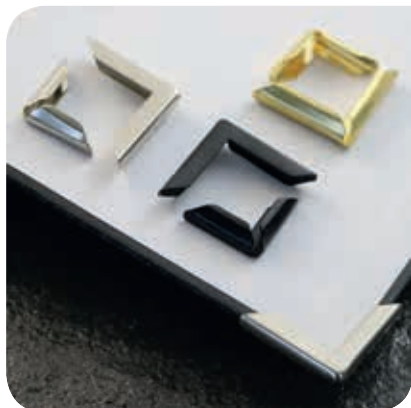

Buchecken

Corner protectors

aus Metall

made of metal

Artikel-Nr. Item no.	Format Size	Füllhöhe filling level	Farbe Colour
BE.C8Z.06 ¹	8 x 8 mm	1,8 mm	■ vernickelt nickel-plated
BE.C8Z.15	8 x 8 mm	1,8 mm	■ vermessingt brass-plated
BE.C10.06	10 x 10 mm	1,7 mm	■ vernickelt nickel-plated
BE.C10.15 ²	10 x 10 mm	1,7 mm	■ vermessingt brass-plated
BE.C15.06	15 x 15 mm	2 mm	■ vernickelt nickel-plated
BE.C15.15	15 x 15 mm	2 mm	■ vermessingt brass-plated
BE.C22.06	22 x 22 mm	1,5 mm	■ vernickelt nickel-plated
BE.C22.15	22 x 22 mm	1,5 mm	■ vermessingt brass-plated
BE.PS16.02	16 x 16 mm	3,5 mm	■ schwarz lackiert black painted
BE.PS16.06	16 x 16 mm	3,5 mm	■ vernickelt nickel-plated
BE.PS16.15	16 x 16 mm	3,5 mm	■ vermessingt brass-plated
BE.PS22.02	22 x 22 mm	3,5 mm	■ schwarz lackiert black painted
BE.PS22.06	22 x 22 mm	3,5 mm	■ vernickelt nickel-plated
BE.PS22.15	22 x 22 mm	3,5 mm	■ vermessingt brass-plated
BE.PS30.02	30 x 30 mm	4 mm	■ schwarz lackiert black painted
BE.PS30.06	30 x 30 mm	4 mm	■ vernickelt nickel-plated
BE.PS30.15	30 x 30 mm	4 mm	■ vermessingt brass-plated
BE.PS31.02 ³	31 x 31 mm	1,5 mm	■ schwarz lackiert black painted
BE.PS31.06	31 x 31 mm	1,5 mm	■ vernickelt nickel-plated
BE.PS31.15	31 x 31 mm	1,5 mm	■ vermessingt brass-plated
BE.PS30CA.06	30 x 30 mm	7 mm	■ vernickelt nickel-plated
BE.PS30CA.15	30 x 30 mm	7 mm	■ vermessingt brass-plated

Bucheckenzange

Corner puncher

Zange für Buchecken aus Metall

corner puncher for metal corner protectors

Artikel-Nr. | Item no.

BE.ZANGE





Buchschauben & -ecken, Ringe, Ösen & Ketten

Binding screws, rings, eyelets & chains

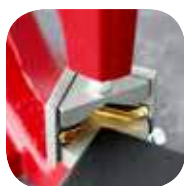

Buchecken-Werkzeug Set

Setting tool for book corners

bestehend aus Oberstempel für M6-Gewinde, Unterstempel zum Stecken mit einem Durchmesser von ca. 12,2 mm

consisting of upper die with M6 thread, lower die cylindric, diameter approx. 12.2 mm

Artikel-Nr. Item no.	Ausführung Description	Material Material
BE.WKZ.20	passend für Buchecken bis 20 mm Schenkellänge for book corners up to 20 mm side length	Werkzeugstahl tool-steel
BE.WKZ.22	passend für Buchecken bis 22 mm Schenkellänge for book corners up to 22 mm side length	Werkzeugstahl tool-steel

Passend für Spindelpresse N4. (Siehe Seite 9.13)
Fitting for spindle press N4. (see page 9.13)

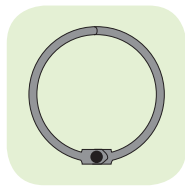

Heftringe

Binding rings

mit Scharnier
hinged

NEU

NEU

NEU

Artikel-Nr. Item no.	Ausführung Description	Farbe Colour
HR.14.01	14 mm Kunststoff plastic	☐ weiß white
HR.14.06.0	14 mm offen geliefert delivered open	■ vernickelt nickel-plated
HR.19.02 ³	19 mm	■ schwarz black
HR.19.06	19 mm	■ vernickelt nickel-plated
HR.19.06.0	19 mm offen geliefert delivered open	■ vernickelt nickel-plated
HR.19.15 ²	19 mm	■ vermessingt brass-plated
HR.25.02	25 mm	■ schwarz black
HR.25.06 ¹	25 mm	■ vernickelt nickel-plated
HR.25.15	25 mm	■ vermessingt brass-plated
HR.32.02	32 mm	■ schwarz black
HR.32.06	32 mm	■ vernickelt nickel-plated
HR.32.15	32 mm	■ vermessingt brass-plated
HR.38.06	38 mm	■ vernickelt nickel-plated
HR.50.06	50 mm	■ vernickelt nickel-plated
HR.63.06	63 mm	■ vernickelt nickel-plated
HR.76.06	76 mm	■ vernickelt nickel-plated
HR.OVAL.22.01	22 mm oval Kunststoff oval plastic	☐ weiß white
HR.OVAL.50.01 ⁴	50 mm oval Kunststoff oval plastic	☐ weiß white
HR.OVAL.50.02	50 mm oval Kunststoff oval plastic	■ schwarz black



Buchschauben & -ecken, Ringe, Ösen & Ketten

Binding screws, rings, eyelets & chains



Warenringe

Merchandise rings

vernickelt
nickel-plated

Artikel-Nr. Item no.	Innen-ø Inner-ø	Ausführung Description
WR.90.06 ¹	90 mm	ohne Haken
WR.90.H.06 ²	90 mm	mit Haken
WR.120.06	120 mm	ohne Haken
WR.120.H.06	120 mm	mit Haken
WR.152.06 ³	152 mm	mit Schraubverschluß
WR.203.06	203 mm	mit Schraubverschluß



Schlüsselringe

Key rings

vernickelt
nickel-plated

Artikel-Nr. Item no.	Außen-ø Outer-ø	Drahtstärke Thickness
SR.16.06	16 mm	1,2 mm
SR.20.06	20 mm	1,4 mm
SR.24.06	24 mm	1,8 mm
SR.30.06	30 mm	1,8 mm



Aufhängeösen

Binding screw hangers

zum Einbinden in Buchschauben
for integrating into binding screws

Artikel-Nr. Item no.	Farbe Colour
BS.0ESE.06	■ vernickelt nickel-plated
BS.0ESE.15	■ vermessingt brass-plated

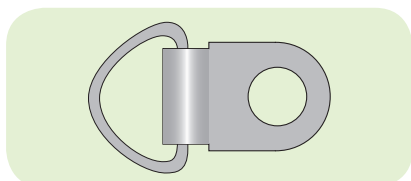



Metallösen, vermessingt

Eyelets, brass-plated

Artikel-Nr. Item no.	Bezeichnung Description	Kopf-ø Head-ø	Schaft-ø Shaft-ø	Schaftlänge Tube length
OE.65.45.32.15	Nr. 24	6,5 mm	4,5 mm	3,2 mm
OE.65.45.40.15	Nr. 25	6,5 mm	4,5 mm	4 mm
OE.67.49.50.15	Nr. 25 1 / 2	6,7 mm	4,85 mm	5 mm
NEU OE.69.45.36.15	ähnlich Typ 24, 25 Similar type 24, 25	6,9 mm	4,5 mm	3,65 mm
OE.75.47.60.15	Nr.26	7,5 mm	4,7 mm	6 mm
OE.80.61.28.15	Nr. 8E kurz No. 8E short	8 mm	6,1 mm	2,8 mm
OE.80.62.35.15	Nr. 8E	8 mm	6,2 mm	3,5 mm
NEU OE.80.59.36.06	ähnlich Typ 8E Similar type 8E	8 mm	5,9 mm	3,6 mm
OE.80.60.43.15	Nr. 8 E4 lang No. 8 E4 long	8 mm	6 mm	4,3 mm
OE.80.60.50.15	Nr. 8 E5 lang No. 8 E5 long	8 mm	6 mm	5 mm
OE.95.57.55.15	Nr. 269	9,5 mm	5,7 mm	5,5 mm
OE.95.57.70.15	Nr. 270	9,5 mm	5,7 mm	7 mm
OE.100.67.75.15	Nr. 271	10 mm	6,65 mm	7,5 mm
OE.100.67.50.15	Nr. 272	10 mm	6,65 mm	5 mm
OE.110.82.40.15	Nr. 9E	11 mm	8,2 mm	4 mm



Metallösen, vernickelt

Eyelets, nickel-plated

Artikel-Nr. Item no.	Bezeichnung Description	Kopf-ø Head-ø	Schaft-ø Shaft-ø	Schaftlänge Tube length
OE.65.45.32.06	Nr. 24	6,5 mm	4,5 mm	3,2 mm
OE.65.45.40.06	Nr. 25	6,5 mm	4,5 mm	4 mm
OE.67.49.50.06	Nr. 25 1 / 2	6,7 mm	4,85 mm	5 mm
NEU OE.69.45.36.06	ähnlich Typ 24, 25 Similar type 24, 25	6,9 mm	4,5 mm	3,65 mm
OE.75.47.60.06	Nr.26	7,5 mm	4,7 mm	6 mm
OE.80.61.28.06	Nr. 8E kurz No. 8E short	8 mm	6,1 mm	2,8 mm
OE.80.62.35.06	Nr. 8E	8 mm	6,2 mm	3,5 mm
NEU OE.80.59.36.06	ähnlich Typ 8E Similar type 8E	8 mm	5,9 mm	3,6 mm
OE.80.60.43.06	Nr. 8 E4 lang No. 8 E4 long	8 mm	6 mm	4,3 mm
OE.80.60.50.06	Nr. 8 E5 lang No. 8 E5 long	8 mm	6 mm	5 mm
OE.95.57.55.06	Nr. 269	9,5 mm	5,7 mm	5,5 mm
OE.95.57.70.06	Nr. 270	9,5 mm	5,7 mm	7 mm
OE.100.67.75.06	Nr. 271	10 mm	6,65 mm	7,5 mm
OE.100.67.50.06	Nr. 272	10 mm	6,65 mm	5 mm
OE.110.82.40.06	Nr. 9E	11 mm	8,2 mm	4 mm



Buchschrauben & -ecken, Ringe, Ösen & Ketten

Binding screws, rings, eyelets & chains



Spindelpresse N4

Spindle press N4

massive Bauweise mit Unter- und Oberstempelaufnahme, für verschiedene Werkzeuge geeignet
 massive type of construction, manual operation with turnable lever

Artikel-Nr. | Item no.

OE.M.SP.N4

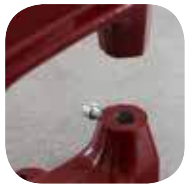

Ös-Werkzeug für Spindelpresse N4

Eyelet setting tool for spindle press N4

Artikel-Nr. | Item no. Ausführung | Description

OE.WKZ.8E¹ passend für Öse 8E, 8E kurz, 8E 4 lang, 8E 5 lang
 for eyelets 8E, 8E short, 8E 4 long, 8E 5 long

OE.WKZ.9E passend für Öse 9E
 for eyelets 9E

OE.WKZ.269 passend für Öse 269
 for eyelets 269

OE.WKZ.270 passend für Öse 270
 or eyelets 270

OE.WKZ.271_272 passend für Öse 271 und 272
 for eyelets 271 and 272

OE.WKZ.24_25_26 passend für Öse 24, 25, 25 ½, 26
 for eyelets 24, 25, 25 ½, 26



Spindelpresse N4 Set

Spindle press N4 set

Artikel-Nr. | Item no. Ausführung | Description

SET.OE.M.SP.S5.8E Spindelpresse N4 mit Werkzeug für Öse 8E, 8E kurz, 8E 4 lang, 8E 5 lang
 Spindle press set with eyelet setting tool for eyelets 8E, 8E short, 8E 4 long, 8E 5 long

SET.OE.M.SP.S5.9E Spindelpresse N4 mit Werkzeug für Öse 9E
 Spindle press set with eyelet setting tool for eyelets 9E

SET.OE.M.SP.S5.269 Spindelpresse N4 mit Werkzeug für Öse 269
 Spindle press set with eyelet setting tool for eyelets 269

SET.OE.M.SP.S5.270 Spindelpresse N4 mit Werkzeug für Öse 270
 Spindle press set with eyelet setting tool for eyelets 270

SET.OE.M.SP.S5.271_272 Spindelpresse N4 mit Werkzeug für Öse 271 und 272
 Spindle press set with eyelet setting tool for eyelets 271 and 272

SET.OE.M.SP.S5.242526 Spindelpresse N4 mit Werkzeug für Öse 24, 25, 25 ½, 26
 Spindle press set with eyelet setting tool for eyelets 24, 25, 25 ½, 26



Buchschrauben & -ecken, Ringe, Ösen & Ketten



Binding screws, rings, eyelets & chains



Ös-Maschine M165

Eyeletting machine M165

Massive Bauweise, mit Magazin und automatischer Ösenzuführung, Ausladung 165 mm
massive type of construction, with hopper and automatic feed, 165 mm throat depth

Artikel-Nr. Item no.	Ausführung Description
OE.M.PM.M165.8E_8E4 ¹	Ös-Maschine M165 mit montiertem Werkzeug für Öse 8E und 8E lang Eyeletting machine M165 with eyelet setting tool for eyelets 8E and 8E long
OE.M.PM.M165.24_25	Ös-Maschine M165 mit montiertem Werkzeug für Öse 24 und 25 Eyeletting machine M165 with eyelet setting tool for eyelets 24 and 25
 OE.M.PM.M165D.8E_8E4 ²	Doppel-Ös-Maschine M165 mit montiertem Werkzeug für Öse 8E und 8E lang Twin headed eyeletting machine M165 with eyelet setting tool for eyelets 8E and 8E long
 OE.M.PM.M165D.24_25	Doppel-Ös-Maschine M165 mit montiertem Werkzeug für Öse 24 und 25 lang Twin headed eyeletting machine M165 with eyelet setting tool for eyelets 24 and 25 long

Für Handbetrieb
For hand operation



Ös-Werkzeug für Maschine M165

Eyelet setting tool for eyeletting machine M165

Artikel-Nr. Item no.	Ausführung Description
OE.WKZ.M165.8E_8E4	passend für Öse 8E und 8E 4 lang for eyelets 8E and 8E 4 long
OE.WKZ.M165.24_25	passend für Öse 24 und 25 for eyelets 24 and 25



Ös-Maschine M80T

Eyeletting machine M80T

Massive Bauweise, mit Magazin und automatischer Ösenzuführung, Ausladung 80 mm
massive type of construction, with hopper and automatic feed, 80 mm throat depth

Artikel-Nr. Item no.	Ausführung Description
OE.M.PM.M80T.8E_8E4	Ös-Maschine M80T mit montiertem Werkzeug für Öse 8E und 8E lang Eyeletting machine M80T with eyelet setting tool for eyelets 8E and 8E long
OE.M.PM.M80T.24_25	Ös-Maschine M80T mit montiertem Werkzeug für Öse 24 und 25 Eyeletting machine M80T with eyelet setting tool for eyelets 24 and 25

Für Handbetrieb
For hand operation

NEU
 now in stock



Buchschrauben & -ecken, Ringe, Ösen & Ketten

Binding screws, rings, eyelets & chains



Ös-Maschine M80PU

Eyeletting machine M80PU

NEU
now in stock

Massive Bauweise, mit Magazin und automatischer Ösenzuführung, Ausladung 80 mm*
massive type of construction, with hopper and automatic feed, 80 mm throat depth*

Artikel-Nr. | Item no. **Ausführung | Description**

OE.M.PM.M80PU.24_25 Ös-Maschine M80PU mit montiertem Werkzeug für Öse 24 und 25
Eyeletting machine M80PU with eyelet setting tool for eyelets 24 and 25

Für Fußbetrieb
For foot operation



Kugeldetten auf Rolle

Ball chain reels

Artikel-Nr. Item no.	Kugeldurchmesser Ball diameter	Meter / Rolle Meters per roll	Farbe Colour
KK.1_5.RL.100.06	1,5 mm	100 m	■ vernickelt nickel-plated
KK.2_4.RL.25.06 ¹	2,4 mm	25 m	■ vernickelt nickel-plated
KK.2_4.RL.25.15A ²	2,4 mm	25 m	■ vermessingt antik antique brass-plated
KK.2_4.RL.25.19A ³	2,4 mm	25 m	■ kupferfarben antik antique copper colored
KK.2_4.RL.100.02 ⁴	2,4 mm	100 m	■ schwarz black
KK.2_4.RL.100.06	2,4 mm	100 m	■ vernickelt nickel-plated
KK.2_4.RL.100.ES.06	2,4 mm	100 m	■ Edelstahl, glänzend stainless steel, glossy
KK.2_4.RL.100.15	2,4 mm	100 m	■ vermessingt brass-plated
KK.3_2.RL.50.06	3,2 mm	50 m	■ vernickelt nickel-plated
KK.4.RL.30.06	4 mm	30 m	■ vernickelt nickel-plated
KK.4_5.RL.30.06	4,5 mm	30 m	■ vernickelt nickel-plated
KK.5.RL.20.06	5 mm	20 m	■ vernickelt nickel-plated
KK.8.RL.10.06	6 mm	10 m	■ vernickelt nickel-plated
KK.6.RL.20.06	6 mm	20 m	■ vernickelt nickel-plated





Kugellketten, abgelängt

Ball chains, cut-to-length

mit Einpressverschluss
with connector

Artikel-Nr. Item no.	Länge Length	Kugeldurchmesser Ball diameter	Farbe Colour
KK.2_4.50.06	50 mm	2,4 mm	■ vernickelt nickel-plated
KK.1_5.102.06	102 mm	1,5 mm	■ vernickelt nickel-plated
KK.2_4.102.02	102 mm	2,4 mm	■ schwarz black
KK.2_4.102.03	102 mm	2,4 mm	■ rot red
KK.2_4.102.04	102 mm	2,4 mm	■ blau blue
KK.102.06	102 mm	2,4 mm	■ vernickelt nickel-plated
KK.2_4.102.07	102 mm	2,4 mm	■ grün green
KK.2_4.102.15	102 mm	2,4 mm	■ vermessingt brass-plated
KK.2_4.102.15A	102 mm	2,4 mm	■ vermessingt antik antique brass-plated
KK.2_4.102.19A	102 mm	2,4 mm	■ kupferfarben antik antique copper colored
KK.3_2.105.06	105 mm	3,2 mm	■ vernickelt nickel-plated
KK.1_5.150.06	150 mm	1,5 mm	■ vernickelt nickel-plated
KK.2_4.150.02	150 mm	2,4 mm	■ schwarz black
KK.2_4.150.03	150 mm	2,4 mm	■ rot red
KK.2_4.150.04	150 mm	2,4 mm	■ blau blue
KK.150.06	150 mm	2,4 mm	■ vernickelt nickel-plated
KK.2_4.150.07	150 mm	2,4 mm	■ grün green
KK.2_4.150.15	150 mm	2,4 mm	■ vermessingt brass-plated
KK.2_4.150.15A	150 mm	2,4 mm	■ vermessingt antik antique brass-plated
KK.2_4.150.19A	150 mm	2,4 mm	■ kupferfarben antik antique copper colored
KK.3_2.150.06	150 mm	3,2 mm	■ vernickelt nickel-plated
KK.1_5.200.06	200 mm	1,5 mm	■ vernickelt nickel-plated
KK.2_4.200.02	200 mm	2,4 mm	■ schwarz black
KK.200.06	200 mm	2,4 mm	■ vernickelt nickel-plated
KK.2_4.200.15	200 mm	2,4 mm	■ vermessingt brass-plated
KK.3_2.200.06	200 mm	3,2 mm	■ vernickelt nickel-plated
KK.2_4.250.06	250 mm	2,4 mm	■ vernickelt nickel-plated
KK.2_4.300.06	300 mm	2,4 mm	■ vernickelt nickel-plated
KK.3_2.300.06	300 mm	3,2 mm	■ vernickelt nickel-plated
KK.2_4.350.06	350 mm	2,4 mm	■ vernickelt nickel-plated
KK.2_4.400.06	400 mm	2,4 mm	■ vernickelt nickel-plated
KK.2_4.450.06	450 mm	2,4 mm	■ vernickelt nickel-plated
KK.2_4.500.06	500 mm	2,4 mm	■ vernickelt nickel-plated
KK.2_4.500.15	500 mm	2,4 mm	■ vermessingt brass-plated
KK.2_4.600.06	600 mm	2,4 mm	■ vernickelt nickel-plated
KK.2_4.700.06	700 mm	2,4 mm	■ vernickelt nickel-plated
KK.2_4.700.15	700 mm	2,4 mm	■ vermessingt brass-plated
KK.2_4.760.NF.06	760 mm	2,4 mm	■ silberfarbig, nickelfrei silver, nickel-free
KK.2_4.800.06	800 mm	2,4 mm	■ vernickelt nickel-plated
KK.2_4.900.06	900 mm	2,4 mm	■ vernickelt nickel-plated
KK.2_4.900.NF.06	900 mm	2,4 mm	■ silberfarbig, nickelfrei silver, nickel-free
KK.2_4.1000.06	1000 mm	2,4 mm	■ vernickelt nickel-plated



Einhängeösen für Kugellketten

Clasps for ball chain

Artikel-Nr. Item no.	für Kugeldurchmesser for ball diameter	Farbe Colour
KK.2_4.EHOE.06	2,4 mm	■ vernickelt nickel-plated
KK.3_2.EHOE.06	3,2 mm	■ vernickelt nickel-plated



Einpressverschlüsse für Kugellketten

Ball chain connectors

Artikel-Nr. Item no.	für Kugeldurchmesser for ball diameter	Farbe Colour
KK.1_5.EPV.06 ¹	1,5 mm	■ vernickelt nickel-plated
KK.2_4.EPV.02 ²	2,4 mm	■ schwarz black
KK.2_4.EPV.06	2,4 mm	■ vernickelt nickel-plated
KK.2_4.EPV.ES.06	2,4 mm	■ Edelstahl, glänzend stainless steel, glossy
KK.2_4.EPV.15	2,4 mm	■ vermessingt brass-plated
KK.2_4.EPV.15A ³	2,4 mm	■ vermessingt antik antique brass-plated
KK.2_4.EPV.19A ⁴	2,4 mm	■ kupferfarben antik antique copper colored
KK.3_2.EPV.06	3,2 mm	■ vernickelt nickel-plated
KK.4.EPV.06	4,0 mm	■ vernickelt nickel-plated
KK.4_5.EPV.06	4,5 mm	■ vernickelt nickel-plated
KK.5.EPV.06	5 mm	■ vernickelt nickel-plated
KK.6.EPV.06	6 mm	■ vernickelt nickel-plated



Drahtseilverbinder mit Drehverschluss

Wire rope connector with screw

mit Drehverschluss, Materialstärke ca. 1,5 mm, aus Edelstahl
with screw, thickness approx. 1.5 mm, made of stainless steel

Artikel-Nr Item no.	Offene Länge Open Length
DI.DV.110.06	110 mm
DI.DV.150.06	150 mm
DI.DV.220.06	220 mm





Flachkopfnägel mit Kappe

Patternbook nails with cover

Kopfdurchmesser Flachkopfnagel: 10 mm, Kopfdurchmesser Kappe: 12 mm

head diameter patternbook: 10 mm, head diameter cover: 12 mm

Artikel-Nr. Item no.	Länge Length	Farbe Colour
SET.NG.F.7.02	7 mm	■ schwarz black
SET.NG.F.7.06	7 mm	■ vernickelt nickel-plated
SET.NG.F.7.15	7 mm	■ vermessingt brass-plated
SET.NG.F.10.02	10 mm	■ schwarz black
SET.NG.F.10.06	10 mm	■ vernickelt nickel-plated
SET.NG.F.10.15	10 mm	■ vermessingt brass-plated
SET.NG.F.15.01	15 mm	□ weiß white
SET.NG.F.15.02	15 mm	■ schwarz black
SET.NG.F.15.06	15 mm	■ vernickelt nickel-plated
SET.NG.F.15.15	15 mm	■ vermessingt brass-plated
SET.NG.F.17_5.01	17,5 mm	□ weiß white
SET.NG.F.17_5.02	17,5 mm	■ schwarz black
SET.NG.F.17_5.06	17,5 mm	■ vernickelt nickel-plated
SET.NG.F.17_5.15	17,5 mm	■ vermessingt brass-plated
SET.NG.F.20.06	20 mm	■ vernickelt nickel-plated
SET.NG.F.20.15	20 mm	■ vermessingt brass-plated
SET.NG.F.25.06	25 mm	■ vernickelt nickel-plated
SET.NG.F.25.15	25 mm	■ vermessingt brass-plated
SET.NG.F.30.06	30 mm	■ vernickelt nickel-plated
SET.NG.F.30.15	30 mm	■ vermessingt brass-plated



Nägel für Musterbücher

Patternbook nails

Kopf Durchmesser: 10 mm

head diameter: 10 mm

Artikel-Nr. Item no.	Länge Length	Ausführung Description	Farbe Colour
NG.20.FL.02 ¹	20 mm	flach flat head	■ schwarz black
NG.20.FL.06	20 mm	flach flat head	■ vernickelt nickel-plated
NG.20.RU.06 ²	20 mm	rund domed head	■ vernickelt nickel-plated
NG.25.FL.02	25 mm	flach flat head	■ schwarz black
NG.25.FL.06	25 mm	flach flat head	■ vernickelt nickel-plated
NG.25.RU.06	25 mm	rund domed head	■ vernickelt nickel-plated



C-Tragegriffe aus Metall

C-handles made of metal

Artikel-Nr. Item no.	Format Size	Farbe Colour
TG.MET.101.06	101 mm Abstand von Loch zu Loch 101 mm measured from hole to hole	■ vernickelt nickel-plated
TG.MET.165.06	165 mm Abstand von Loch zu Loch 165 mm measured from hole to hole	■ vernickelt nickel-plated

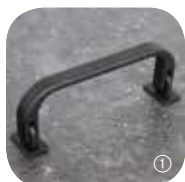

Tragegriffe aus Kunststoff

Handles made of plastic

mit 2 passenden Halteösen
with two eyelets

Artikel-Nr. Item no.	Format Size	Farbe Colour
TG.GR.115045.01 ¹	114 x 45 x 9 mm, rechteckig 114 x 45 x 9 mm, rectangular	□ weiß white
TG.GR.115045.02	114 x 45 x 9 mm, rechteckig 114 x 45 x 9 mm, rectangular	■ schwarz black
TG.GR.118040.01	118 x 40 x 11 mm, rechteckig 118 x 40 x 11 mm, rectangular	□ weiß white
TG.GR.118040.02	118 x 40 x 11 mm, rechteckig 118 x 40 x 11 mm, rectangular	■ schwarz black
TG.GR.136045.01 ²	136 x 45 x 9 mm, oval 136 x 45 x 9 mm, oval	□ weiß white
TG.GR.136045.02	136 x 45 x 9 mm, oval 136 x 45 x 9 mm, oval	■ schwarz black



Trageschlaufen aus Kunststoff

Strap handle made of plastic

2 fach gelocht
with 2 holes

Artikel-Nr. Item no.	Durchmesser Diameter	Farbe Colour
TG.SCHL.300.2L.00	300 x 25 x 2,5 mm	☐ transparent transparent
TG.SCHL.300.2L.01	300 x 25 x 2,5 mm	□ weiß white
TG.SCHL.300.2L.02	300 x 25 x 2,5 mm	■ schwarz black
TG.SCHL.320.2L.00	320 x 25 x 1,0 mm	☐ transparent transparent
TG.SCHL.320.2L.01	320 x 25 x 1,0 mm	□ weiß white
TG.SCHL.320.2L.02	320 x 25 x 1,0 mm	■ schwarz black



Kunststoff-Kollektionshaken

Display hooks made of plastic

Artikel-Nr. Item no.	Format Size	Farbe Colour
KH.072072.00	72 x 72 mm	☐ transparent transparent
KH.072072.01	72 x 72 mm	☐ weiß white
KH.072072.02	72 x 72 mm	■ schwarz black



Metall-Kollektionshaken & -platten

Display hooks and plates made of metal

Artikel-Nr. Item no.	Länge Length	Ausführung Description	Farbe Colour
KH.M.3_8.77.06 ²	3,8 x 77 mm		■ vernickelt nickel-plated
KH.M.3_8.77.06Z	3,8 x 77 mm		■ verzinkt zinc plated
KH.M.3_8.77.15	3,8 x 77 mm		■ vermessingt brass-plated
KH.M.4.68.06	4 x 68 mm		■ vernickelt nickel-plated
KH.M.4.68.06Z	4 x 68 mm		■ verzinkt zinc plated
KH.M.4.68.15	4 x 68 mm		■ vermessingt brass-plated
KH.M.3_3.65.S180.02	3,3 x 65 mm	mit Schiene, verzinkt with rail, zinc plated	■ schwarz black
KH.M.3_3.65.S180.06	3,3 x 65 mm	mit Schiene, verzinkt with rail, zinc plated	■ vernickelt nickel-plated
KH.M.3_3.65.S180.15 ¹	3,3 x 65 mm	mit Schiene, verzinkt with rail, zinc plated	■ vermessingt brass-plated
SET.KH.M.3_4.60.M4_MU.06Z	3,4 x 60 mm	M4 Gewinde mit Mutter M4 thread with nut	■ verzinkt zinc-plated
SET.KH.M.3_4.60.M4_MU.15	3,4 x 60 mm	M4 Gewinde mit Mutter M4 thread with nut	■ vermessingt brass-plated
SET.KH.M.4.78.M5_MU.06Z	4 x 78 mm	M5 Gewinde mit Mutter M5 thread with nut	■ verzinkt zinc-plated
SET.KH.M.4.78.M5_MU.15 ³	4 x 78 mm	M5 Gewinde mit Mutter M5 thread with nut	■ vermessingt brass-plated
SET.KH.M4_2.86.M5_MU.06Z	4,2 x 86 mm	M5 Gewinde mit Mutter M5 thread with nut	■ verzinkt zinc-plated
SET.KH.M4_2.86.M5_MU.15	4,2 x 86 mm	M5 Gewinde mit Mutter M5 thread with nut	■ vermessingt brass-plated



Platten mittig gelocht, Lochdurchmesser: 5,2 mm

with centred hole, hole diameter: 5,2 mm

Artikel-Nr. Item no.	Länge Length	Ausführung Description	Farbe Colour
KH.PL.100008.2L.06Z ⁴	100 x 8 x 2 mm		■ verzinkt zinc plated
KH.PL.100010.2.L.06Z	100 x 10 x 2 mm		■ verzinkt zinc plated



Steckverschlüsse

Locks

mit Halteösen aus Kunststoff

with eyelets made of plastic

Artikel-Nr. Item no.	Format Size	Farbe Colour
TG.VS.040025.01	40 x 25 x 9 mm	☐ weiß white
TG.VS.040025.02	40 x 25 x 9 mm	■ schwarz black



Abbildung ähnlich
similar product

Druckknöpfe

Press fasteners

4-teilig, bestehend aus Kappe, Federteil, Kugelteil und Nietteil

4-parts, consisting of cap, socket, towball and fastener

Artikel-Nr. Item no.	Type	Kappendurchmesser Head diameter	Farbe Colour
SET.DR.S.12_4.06	S	12,4 mm	■ vernickelt nickel-plated
SET.DR.R.12_4.06	R	12,4 mm	■ vernickelt nickel-plated
SET.DR.R.15_0.06	R	15 mm	■ vernickelt nickel-plated
SET.DR.R.15_5.06	R	15,5 mm	■ vernickelt nickel-plated



Werkzeug-Set für Kappen & Federteile der Druckknöpfe

Tool-set for cap and socket of press fasteners

bestehend aus Oberstempel mit M6-Gewinde, Unterstempel zum Stecken
mit einem Durchmesser von ca. 12 mm

consisting of upper die with M6 thread, lower die for plug-in with diameter of approx. 12 mm

Artikel-Nr. Item no.	Type	Kappendurchmesser Head diameter	Material
SET.DR.WKZ.S.12_4 ¹	S	12,4 mm	Werkzeugstahl tool steel
SET.DR.WKZ.R.12_4 ²	R	12,4 mm	Werkzeugstahl tool steel
SET.DR.WKZ.R.15_0	R	15 mm	Werkzeugstahl tool steel
SET.DR.WKZ.R.15_5	R	15,5 mm	Werkzeugstahl tool steel

Passend für Spindelpresse N4. (Siehe Seite 9.13)

Fitting for spindle press N4. (see page 9.13)



Druckknopfstifte

Pillar press fasteners

4-teilig, bestehend aus Kappe, Federteil, Schaft und Einspitzstift,
Kappendurchmesser: 12,4 mm

4-parts, consisting of cap, socket, pillar and stud cap diameters: 12,4 mm

Artikel-Nr. Item no.	Schafthöhe Tube length	Farbe Colour
SET.DR.PI.6.01	6 mm	☐ weiß white
SET.DR.PI.6.02	6 mm	■ schwarz black
SET.DR.PI.6.06	6 mm	■ vernickelt nickel-plated
SET.DR.PI.6.15	6 mm	■ vermessingt brass-plated
SET.DR.PI.9.01 ¹	9 mm	☐ weiß white
SET.DR.PI.9.02 ²	9 mm	■ schwarz black
SET.DR.PI.9.06 ³	9 mm	■ vernickelt nickel-plated
SET.DR.PI.9.15 ⁴	9 mm	■ vermessingt brass-plated
SET.DR.PI.12.01	12 mm	☐ weiß white
SET.DR.PI.12.02	12 mm	■ schwarz black
SET.DR.PI.12.06	12 mm	■ vernickelt nickel-plated
SET.DR.PI.12.15	12 mm	■ vermessingt brass-plated
SET.DR.PI.15.01	15 mm	☐ weiß white
SET.DR.PI.15.02	15 mm	■ schwarz black
SET.DR.PI.15.06	15 mm	■ vernickelt nickel-plated
SET.DR.PI.15.15	15 mm	■ vermessingt brass-plated
SET.DR.PI.17.01	17 mm	☐ weiß white
SET.DR.PI.17.02	17 mm	■ schwarz black
SET.DR.PI.17.06	17 mm	■ vernickelt nickel-plated
SET.DR.PI.17.15	17 mm	■ vermessingt brass-plated
SET.DR.PI.22.01	22 mm	☐ weiß white
SET.DR.PI.22.02	22 mm	■ schwarz black
SET.DR.PI.22.06	22 mm	■ vernickelt nickel-plated
SET.DR.PI.22.15	22 mm	■ vermessingt brass-plated
SET.DR.PI.27.01	27 mm	☐ weiß white
SET.DR.PI.27.02	27 mm	■ schwarz black
SET.DR.PI.27.06	27 mm	■ vernickelt nickel-plated
SET.DR.PI.27.15	27 mm	■ vermessingt brass-plated



Werkzeug-Set für Kunststoffschäfte & Einspitzstifte der Druckknopfstifte

Tool-set for pillar and stud of the pillar press fasteners

bestehend aus Oberstempel mit M6-Gewinde, Unterstempel zum Stecken
mit einem Durchmesser von ca. 12 mm

consisting of upper die with M6 thread, lower die for plug-in with diameter of approx. 12 mm

Artikel-Nr. Item no.	Passend für Kappendurchmesser Fits for head diameter	Material Material
SET.DR.WKZ.PI	12,4 mm	Werkzeugstahl tool steel

Passend für Spindelpresse N4. (Siehe Seite 9.13)

Fitting for spindle press N4. (see page 9.13)



Bindestifte mit Verschlusshülse

Ratchet post fasteners with tube

aus Kunststoff

made of plastic

Artikel-Nr. Item no.	Länge Length	Farbe Colour
SET.DOE.BM.45.VH.01	45 mm	<input type="checkbox"/> weiß white
SET.DOE.BM.45.VH.02	45 mm	<input checked="" type="checkbox"/> schwarz black
SET.DOE.BM.65.VH.01	65 mm	<input type="checkbox"/> weiß white
SET.DOE.BM.65.VH.02	65 mm	<input checked="" type="checkbox"/> schwarz black
SET.DOE.BM.85.VH.01	85 mm	<input type="checkbox"/> weiß white
SET.DOE.BM.85.VH.02	85 mm	<input checked="" type="checkbox"/> schwarz black
SET.DOE.BM.140.VH.01	140 mm	<input type="checkbox"/> weiß white
SET.DOE.BM.140.VH.02	140 mm	<input checked="" type="checkbox"/> schwarz black
SET.DOE.BM.205.VH.01	205 mm	<input type="checkbox"/> weiß white
SET.DOE.BM.205.VH.02	205 mm	<input checked="" type="checkbox"/> schwarz black

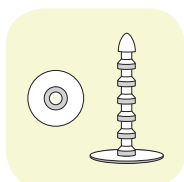

Bindestifte mit Verschluss Scheibe

Ratchet post fasteners with washer

aus Kunststoff

made of plastic

Artikel-Nr. Item no.	Länge Length	Farbe Colour
SET.DOE.BM.45.VS.01	45 mm	<input type="checkbox"/> weiß white
SET.DOE.BM.45.VS.02	45 mm	<input checked="" type="checkbox"/> schwarz black
SET.DOE.BM.65.VS.01	65 mm	<input type="checkbox"/> weiß white
SET.DOE.BM.65.VS.02	65 mm	<input checked="" type="checkbox"/> schwarz black
SET.DOE.BM.85.VS.01	85 mm	<input type="checkbox"/> weiß white
SET.DOE.BM.85.VS.02	85 mm	<input checked="" type="checkbox"/> schwarz black
SET.DOE.BM.140.VS.01	140 mm	<input type="checkbox"/> weiß white
SET.DOE.BM.140.VS.02	140 mm	<input checked="" type="checkbox"/> schwarz black
SET.DOE.BM.205.VS.01	205 mm	<input type="checkbox"/> weiß white
SET.DOE.BM.205.VS.02	205 mm	<input checked="" type="checkbox"/> schwarz black

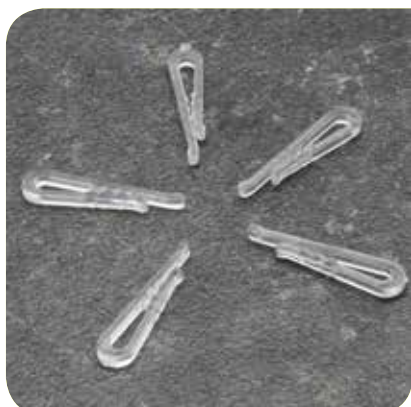

Konfektionsklammern

Garment clips

Kunststoff

plastic

Artikel-Nr. Item no.	Format Size	Farbe Colour
KH.KM.038004.00	38 x 4 mm	<input checked="" type="checkbox"/> transparent transparent



Display-Artikel
Display accessories





Display-Artikel

Display accessories



Eurolochaufhänger

Hanging tabs

selbstklebend, transparent, auf Rolle

self-adhesive, transparent, supplied on rolls

Artikel-Nr. Item no.	Ausführung Description
EA.018045.HPVC035.HAKEN ²	18 x 45 mm, für Gewichte bis 200 g, Haken 18 x 45 mm, for weights up to 200 g, hook
EA.025035.RL.500	25 x 35 mm, für Gewichte bis 250 g, Rundloch 25 x 35 mm, for weights up to 250 g, round hole
EA.040032.HPVC035.500 ¹	40 x 32 mm, für Gewichte bis 500 g 40 x 32 mm, for weights up to 500 g, euro hole
EA.043035.DELTA.500	43 x 35 mm, für Gewichte bis 275 g, Lochausstanzung ausgebrochen 43 x 35 mm, for weights up to 275 g, slot removed
EA.044036.FLEXI.BL.500	44 x 36 mm, für Gewichte bis 250 g, flexibel, Lochausstanzung ausgebrochen, je 10 St. auf Block 44 x 36 mm, for weights up to 250 g, flexible, slot removed, 10 tabs per book
EA.044036.FLEXI.500	44 x 36 mm, für Gewichte bis 250 g, flexibel, Lochausstanzung ausgebrochen 44 x 36 mm, for weights up to 250 g, flexible, slot removed
EA.044045.HPVC035.500	44 x 45 mm, für Gewichte bis 400 g, T-Form 44 x 45 mm, for weights up to 400 g, t-shape, euro hole
EA.044052.HPVC035.500	44 x 52 mm, für Gewichte bis 1.000 g 44 x 52 mm, for weights up to 1.000 g, euro hole
EA.047050.FLEXI.500	47 x 50 mm, für Gewichte bis 300 g, flexibel (kann umgeklappt werden) 47 x 50 mm, for weights up to 300 g, foldable, euro hole
EA.050027.EV.500	50 x 27 mm, Eurolocherstärker, Lochausstanzung ausgebrochen 50 x 27 mm, euro hole enforcer, slot removed
EA.050050.FLEXI.500	50 x 50 mm, für Gewichte bis 400 g, flexibel, Lochausstanzung ausgebrochen 50 x 50 mm, for weights up to 400 g, foldable, slot removed
EA.050050.FLEXI.BL.500	50 x 50 mm, für Gewichte bis 400 g, Lochausstanzung ausgebrochen, je 10 St. auf Block 50 x 50 mm, for weights up to 400 g, slot removed, 10 tabs per book
EA.050050.FLEXI.DP.500 ³	50 x 50 mm, für Gewichte bis 500 g, doppelt 50 x 50 mm, for weights up to 500 g, double
EA.062035.KL.PET040.500	62 x 35 mm, für Gewichte bis 400 g, Haken ausklappbar 62 x 35 mm, for weights up to 400 g, hook foldable, euro hole

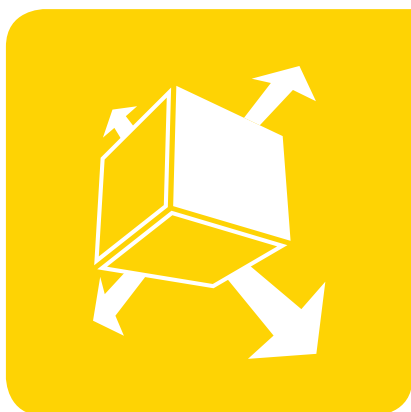

Eurolochaufhänger nach Kundenwunsch

Hanging tabs - customised

-  Mindestmenge: 20.000 Stück
minimum quantity: 20,000 pieces
-  Sonderformate in fast jeder gewünschten Abmessung
custom-made in nearly all desired dimensions
-  unterschiedlichste Lochungen
different punch hole sizes
-  verschiedene Folienarten und Folienstärken
different foil types and thicknesses
-  spezielle Ausführungen (z.B. flexibel, klappbar, etc.)
available in different versions (e.g. flexible, foldable, etc.)
-  auf Rolle, Bogen oder lose
on rolls, sheets or loose



Display-Artikel

Display accessories

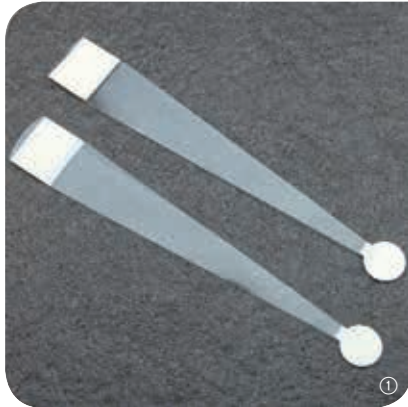

Regalwipper, wippend

Wobblers

mit Klebeflächen / Klebepunkten
with self-adhesive pads

Artikel-Nr. Item no.	Ausführung Description
RW.75.2KF ²	75 mm lang, transparent, mit PE-Schaum Klebeflächen an beiden Enden length 75 mm, transparent, with self-adhesive pads on both ends made of PE foam
RW.150.2KF.A.PET028	150 x 15 mm, transparent, mit Klebeflächen an beiden Enden, schwach haftendes Klebeband für leichte Schilder, von vielen Untergründen rückstandslos entfernbar, rechteckige parallele Form 150 x 15 mm, transparent, with self-adhesive pads (tissue tape) on both ends, low adhesive (acrylic) rectangular
RW.150.2KF.P.PET028	150 x 15 mm, transparent, mit Klebeflächen (transparentes Klebeband) mit Fingerlift an beiden Enden, rechteckige parallele Form 150 x 15 mm, transparent, with self-adhesive pads (tissue tape) on both ends, rectangular
RW.150.2KF.PET028	150 x 15 mm, transparent, mit Klebeflächen (PE-Schaum Klebeband) mit Fingerlift an beiden Enden, rechteckige parallele Form 150 x 15 mm, transparent, with self-adhesive pads on both ends, permanent (hotmelt) with strap on both ends, rectangular
NEU RW.150.2KF.AF_PE.PET028A	150 x 15 mm, transparent, mit 1x PE-Schaum- und 1x Reinacrylatklebefläche, rückstandslos entfernbar 150 x 15 mm, with 1 PE-foam self-adhesive (hotmelt), 1 acrylic-adhesive pad (highly transparent)
RW.150.2KF.19	152 x 7 / 11 mm, transparent, mit PE-Schaum Klebeflächen an beiden Enden 152 x 7 / 11 mm, transparent, with self-adhesive pads on both ends made of PE foam
RW.170.2KP.PET028	170 mm lang, transparent, mit großen PE-Schaumklebepunkten mit Anfasslaschen an beiden Enden length 170 mm, transparent, with self-adhesive pads on both ends
RW.170.2KF.P.PET028	170 x 15 mm, transparent, mit Klebeflächen (transparentes Klebeband) mit Fingerlift an beiden Enden, rechteckige parallele Form 170 x 15 mm, transparent, with self-adhesive pads (tissue tape) on both ends, rectangular
RW.170.2KF.PET028	170 x 15 mm, transparent, mit Klebeflächen (PE-Schaum Klebeband) mit Fingerlift an beiden Enden, rechteckige parallele Form 170 x 15 mm, transparent, with self-adhesive pads (PE-foam) on both ends, rectangular
RW.200.2KF.HPVC040.19	200 x 5 / 15 mm, transparent, mit PE-Schaum Klebeflächen an beiden Enden 200 x 5 / 15 mm, transparent, with self-adhesive pads on both ends made of PE foam
RW.208.2KF.PET038 ¹	208 mm, transparent, mit PE-Schaum Klebeflächen an beiden Enden 208 mm, transparent, with self-adhesive pads on both ends made of PE foam
RW.208.2KP.AF_PE.PET038 ³	208 mm, transparent, mit Klebepunkten an beiden Enden, Klebepunkt aus Reinacrylat auf der breiten Seite length 208 mm, transparent, with self-adhesive pads on both ends, adhesive disc made of acrylicfoam at the wide side
RW.210.H	210 mm lang, transparent, mit ausgestanztem Dreieck (Haken) auf der einen und Klebepunkt auf der anderen Seite length 210 mm, transparent, with punched out triangle (hook) on one side, self-adhesive pad on the other side
RW.215.SCAN.KP	215 mm lang, transparent, 25 mm breit für Scannerschiene auf der einen und Klebepunkt auf der anderen Seite length 215 mm, transparent, 25 mm wide for scanner rail and other end with self-adhesive pad

Regalwipper, biegsam

Wobblers, bendable

PE-Schaumklebeflächen / -klebepunkte, stark haftend
with self-adhesive pads made of PE foam, permanent adhesive



Artikel-Nr. Item no.	Ausführung Description
RW.75.2KF.06 ¹	75 mm lang, Aluminium (biegsam), mit Klebeflächen an beiden Enden length 75 mm, aluminium (bendable), with self-adhesive pads on both ends
RW.150.2KF.06	150 mm lang, Aluminium (biegsam), mit Klebeflächen an beiden Enden length 150 mm, aluminium (bendable), with self-adhesive pads on both ends
NEU RW.195.2KF.06	195 mm lang, Aluminium (biegsam), mit je zwei Klebeflächen an beiden Enden length 195 mm, aluminium (bendable), with 2 self-adhesive pads on both ends
RW.DT.90.01 ²	Dekotab 90 mm lang, weiß (biegsam), mit je zwei Klebeflächen an den Enden Dekotab length 90 mm, white (bendable), with two self-adhesive pads on both ends.
RW.DT.160.01	Dekotab 160 mm lang, weiß (biegsam), mit je zwei Klebeflächen an den Enden Dekotab length 160 mm, white (bendable), with zwei self-adhesive pads on both ends



Display-Artikel

Display accessories



Deko-Spring

Spring wobblers

jeweils mit PE-Schaumklebepunkten an den Enden, stark haftend
with PE foam self-adhesive pads on both ends, permanent adhesive

Artikel-Nr. | Item no. Ausführung | Description

RW.DS.30.2KP Spezialfeder 30 mm lang | *special spring, length 30 mm*



Abstandshalter

Spacers

jeweils mit Klebepunkten an den Enden, weiß
self-adhesive pads on both ends, white

Artikel-Nr. | Item no. Länge | Length

DI.AB.20.2KP.01 20 mm

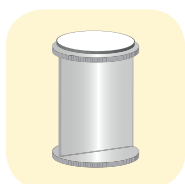

Verbindungselemente

Connection elements

Kunststoff, Klemmwirkung, transparent
plastic, with clamping assembly, transparent

Artikel-Nr. | Item no. Ausführung | Description Länge | Length

DI.VE.025022.00 ¹ Doppelgrip
double grip 25 x 22 mm

DI.VE.025.L.00 Montage von 2 Schildern, Schilder stehen im 90°-Winkel
for 2 cards, cards are at a 90° angle 25 mm

DI.VE.025.V.00 Montage von 2 Schildern, Schilder stehen im 60°-Winkel
for 2 cards, cards are at a 60° angle 25 mm

DI.VE.025.Y.00 Montage von 3 Schildern, Schilder stehen im 120°-Winkel
for 3 cards, cards are at a 120° angle 25 mm

DI.VE.025.X.00 ² Montage von 4 Schildern, Schilder stehen im 90°-Winkel
for 4 cards, cards are at a 90° angle 25 mm

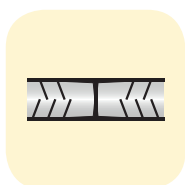



Display-Artikel

Display accessories

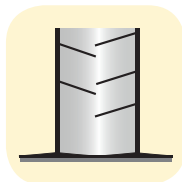

Kartenhalter

Card holders

Kunststoff, transparent, mit Klemmwirkung
plastic, transparent, with clamping assembly

Artikel-Nr. Item no.	Format Size	Ausführung Description	Schildausrichtung Label direction
NEU DI.KH.015012.SK.00	15 x 12 mm	selbstklebend self-adhesive	steht im 90°-Winkel at an angle of 90 degrees
DI.KH.025012.SK.00 ¹	25 x 12 mm	selbstklebend self-adhesive	steht im 90°-Winkel at an angle of 90 degrees
DI.KH.025019.SK.00	25 x 19 mm	selbstklebend self-adhesive	steht im 90°-Winkel at an angle of 90 degrees
DI.KH.025025.SK.00	25 x 25 mm	selbstklebend self-adhesive	steht im 90°-Winkel at an angle of 90 degrees
NEU DI.KH.038012.SK.00	38 x 12 mm	selbstklebend self-adhesive	steht im 90°-Winkel at an angle of 90 degrees
NEU DI.KH.038025.SK.00	38 x 25 mm	selbstklebend self-adhesive	steht im 90°-Winkel at an angle of 90 degrees
DI.KH.075012.SK.00	75 x 12 mm	selbstklebend self-adhesive	steht im 90°-Winkel at an angle of 90 degrees
DI.KH.075019.SK.00	75 x 19 mm	selbstklebend self-adhesive	steht im 90°-Winkel at an angle of 90 degrees
DI.KH.075025.SK.00	75 x 25 mm	selbstklebend self-adhesive	steht im 90°-Winkel at an angle of 90 degrees
NEU DI.KH.150025.SK.00	150 x 25 mm	selbstklebend self-adhesive	steht im 90°-Winkel at an angle of 90 degrees
DI.KH.025020.SK.PA.00 ³	25 x 20 mm	selbstklebend self-adhesive	steht parallel zum Regal parallel to the shelf
DI.KH.025025.FL.SK.00	25 x 25 mm	selbstklebend flexibel self-adhesive flexibel	steht im 90°-Winkel at an angle of 90 degrees
DI.KH.075025.FL.SK.00 ²	75 x 25 mm	selbstklebend flexibel self-adhesive flexibel	steht im 90°-Winkel at an angle of 90 degrees
DI.KH.018025.90G.00 ⁵	18 x 25 mm	L-Form L-shaped	steht im 90°-Winkel at an angle of 90 degrees
DI.KH.020038.FL.00	20 x 38 mm	zum Einstecken in Scannerschienen, flexibel to insert in scanner rails, flexibel	steht im 90°-Winkel at an angle of 90 degrees
DI.KH.020038.00 ⁴	20 x 38 mm	zum Einstecken in Scannerschienen to insert in scanner rails	steht im 90°-Winkel at an angle of 90 degrees
DI.DG.013.00	13 mm	zum Einstecken in Drahtkörbe, Drahtgrip to insert in wire baskets, Wire grip	steht im 90°-Winkel at an angle of 90 degrees
NEU DI.KH.075025.MS.00	75 x 25 mm	magnetisch flexibel magnetically flexible	steht im 90°-Winkel at an angle of 90 degrees
NEU DI.KH.075025.FL.MS.00	75 x 25 mm	magnetisch magnetically	steht im 90°-Winkel at an angle of 90 degrees
NEU DI.KH.150025.MS.00	150 x 25 mm	magnetisch magnetically	steht im 90°-Winkel at an angle of 90 degrees

- Außerdem im Angebot** | Also available
- Saugnapfe mit integriertem Kartenhalter. (Siehe Seite 16.3)
- We also offer suction cups with integrated card holder. (see page 16.3)



Flaschenringe

Bottle rings

Kunststoff, milchig-transparent
plastic, clear frosted

Artikel-Nr. Item no.	Durchmesser Diameter
DI.FR.40.00	40 mm



Display-Artikel

Display accessories

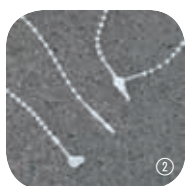

Sicherheitsfäden / Rasterschleufe

Loop pins / Stepped loop pins

Kunststoff natur, milchig-transparent

plastic, clear frosted

Artikel-Nr. | Item no. Länge | Length Ausführung | Description

SE.75.01 ¹	75 mm	
SE.125.01	125 mm	
SE.RS.125.01 ²	125 mm	Rasterschleufen Stepped loop pins
SE.225.01	225 mm	



Kordeln mit Einsteckbox

Loop pins / Stepped loop pins

Artikel-Nr. | Item no. Länge | Length Farbe | Colour Ausführung | Description

KO.120.BX.0710.1KS.01 ¹	120 mm	<input type="checkbox"/> weiß white	Gedrehte Kordel mit Einsteckbox twisted cord with box
KO.120.BX.0710.1KS.02	120 mm	<input checked="" type="checkbox"/> schwarz black	Gedrehte Kordel mit Einsteckbox twisted cord with box
KO.120.BX.0710.1KS.06	120 mm	<input type="checkbox"/> silber silver	Gedrehte Kordel mit Einsteckbox twisted cord with box
KO.120.BX.0710.1KS.13	120 mm	<input checked="" type="checkbox"/> gold gold	Gedrehte Kordel mit Einsteckbox twisted cord with box
KO.200.BX.0710.1KS.01	200 mm	<input type="checkbox"/> weiß white	Gedrehte Kordel mit Einsteckbox twisted cord with box
KO.200.BX.0710.1KS.02	200 mm	<input checked="" type="checkbox"/> schwarz black	Gedrehte Kordel mit Einsteckbox twisted cord with box
KO.200.BX.0710.1KS.06	200 mm	<input type="checkbox"/> silber silver	Gedrehte Kordel mit Einsteckbox twisted cord with box
KO.200.BX.0710.1KS.13 ²	200 mm	<input checked="" type="checkbox"/> gold gold	Gedrehte Kordel mit Einsteckbox twisted cord with box
KO.235.BX.1010.2KS.01	235 mm	<input type="checkbox"/> weiß white	Gedrehte Kordel mit 2 Splinten und Einsteckbox Twisted cord with 2 bars and box
KO.235.BX.1010.2KS.02 ³	235 mm	<input checked="" type="checkbox"/> schwarz black	Gedrehte Kordel mit 2 Splinten und Einsteckbox Twisted cord with 2 bars and box



Weitere Ausführungen möglich | Other versions available



Display-Artikel

Display accessories



Nylonclip

Nylon clip

milchig-transparent

clear frosted

Artikel-Nr. | Item no. Länge | Length

DI.NC.50.00 50 mm

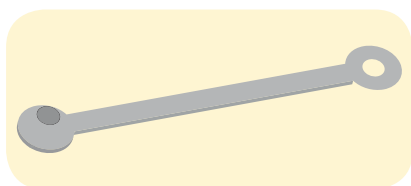

Abhängefedern JetSnabb

JetSnabbs

vernickelt

nickel-plated

Artikel-Nr. <i>Item no.</i>	für Gewichte <i>for weights</i>	Länge <i>Length</i>	Ausführung <i>Description</i>
JS.20.06	bis 400 g <i>up to 400 g</i>	165 mm	ausziehbar auf 1,5 m <i>extendible up to 1.5 m</i>
JS.40.06	bis 1.000 g <i>up to 1,000 g</i>	205 mm	ausziehbar auf 1,5 m <i>extendible up to 1.5 m</i>
JS.60.06	bis 1.000 g <i>up to 1,000 g</i>	320 mm	ausziehbar auf 3 m <i>extendible up to 3 m</i>

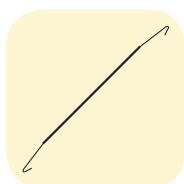

Haken mit Schnur

Wire hangers with cord

für Gewichte bis 700 g

for weights up to 700 g

Artikel-Nr. Item no.	Ausführung Description
HK.1_5M.MS ¹	1,5 m lange Nylonschnur inkl. Metallsplint, Standardhaken vernickelt <i>1.5 m nylon cord incl. metallic pin, standard hook nickel-plated</i>
HK.1_5M.MS.G	1,5 m lange Nylonschnur inkl. Metallsplint, großer Haken vernickelt <i>1.5 m nylon cord incl. metallic pin, large hook nickel-plated</i>
HK.1_7M.P	1,7 m langer Polyesterfaden mit transparenter Perle, Standardhaken vernickelt <i>1.7 m polyester cord incl. transparent pearl, standard hook nickel-plated</i>

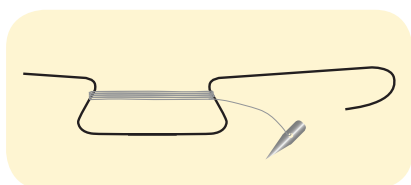



Display-Artikel

Display accessories



S-Haken

S-hooks

als Verbindungsteile
for use as connection parts

Artikel-Nr. Item no.	Länge Length	Farbe Colour	Material Material
HK.S.35.06 ¹	35 mm	■ verzinkt galvanized	Draht wire
HK.S.55.00 ²	55 mm	□ transparent transparent	Kunststoff plastic
HK.S.55.01	55 mm	□ weiß white	Kunststoff plastic
HK.S.65.06	65 mm	■ verzinkt galvanized	Draht wire



C-Haken

C-hooks

als Verbindungsteile
for use as connection parts

Artikel-Nr. Item no.	Länge Length	Farbe Colour	Material Material
HK.C.35.06 ¹	35 mm	■ verzinkt galvanized	Draht wire
HK.C.38.00 ²	38 mm	□ transparent transparent	Kunststoff plastic
HK.C.38.01	38 mm	□ weiß white	Kunststoff plastic
HK.C.39.2.06	39 mm	■ verzinkt galvanized	Draht wire
HK.C.62.06	62 mm	■ verzinkt galvanized	Draht wire
HK.C.500.06	500 mm	■ verzinkt galvanized	Draht wire
HK.C.700.06	700 mm	■ verzinkt galvanized	Draht wire



Aufhängehaken

Suspension hook

mit Klemmlasche, Kunststoff, milchig-transparent
with reclosable loop, plastic, clear frosted

Artikel-Nr. Item no.	Format Size
DI.HK.53.00	53 x 24 mm





Display-Artikel

Display accessories



Klebspunkte mit Öse

Self-adhesive pads with eyelet

selbstklebend, weiß
self-adhesive, white

Artikel-Nr. Item no.	Format Size	Ausführung Description
KP.OE.20.01 ¹	ø 20 mm	
KP.OE.2020.01	20 x 20 mm	
KP.OE.2040.01	20 x 40 mm	
KP.OE.2637.01	26 x 37 mm	
KP.OE.3030.D.01 ²	30 x 30 mm	Öse drehbar turnable eyelet



Decken-Cliphaken mit Öse

Suspended ceiling clip with eyelet

Kunststoff, milchig-transparent
plastic, clear frosted

Artikel-Nr. Item no.	Format Size
DI.DE.019019.01	19 x 19 mm

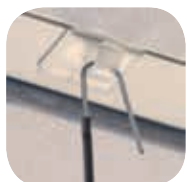

Mobile-Verbinder

Mobile strings

weißer Faden mit transparenten Kügelchen an beiden Enden
white cord with transparent beads at both ends

Artikel-Nr. Item no.	Länge Length
DI.MV.60.01	60 mm
DI.MV.80.01	80 mm
DI.MV.100.01	100 mm





Display-Artikel

Display accessories



Nylonfaden auf Rolle

Nylon cord reels

endlos auf Rolle, Materialstärke ca. 0,4 mm, mit max. Tragkraft bis 7,5 kg, transparent
nylon cord reels, material thickness approx. 0.4 mm, for weights up to 7.5 kilos, transparent

Artikel-Nr. | Item no. Länge | Length

NF.O_4.200 200 m



Deckenspinne, verzinkt

Suspended ceiling clip with eyelet, galvanized

Klammer für Deckenprofile, Materialstärke ca. 1,5 mm
for ceiling profiles, material thickness approx. 1.5 mm

Artikel-Nr. | Item no. passend für | suitable for

HK.DS.40.06 40 mm

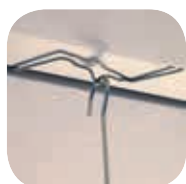

Deckenspinne, Form „8“, verzinkt

Suspended ceiling clip, "8" shape, galvanized

Klammer für Deckenprofile, Materialstärke ca. 1,5 mm
for ceiling profiles, material thickness approx. 1.5 mm

Artikel-Nr. | Item no. Format | Size

HK.DS.8.06 62 x 26 mm





Display-Artikel

Display accessories



Sign-Clip – Preishalter mit Kugelgelenk

Sign-Clip – price holder with ball joint

PC-Kunststoff, transparent
PC-plastic, transparent

Artikel-Nr. | Item no. **Ausführung | Description**

DI.SC.KK_PH50.70.00¹ mit kleiner Klammer, Preishalter 50 mm breit mit Klemmwirkung, Gesamthöhe 70 mm
with small clamp, price holder 50 mm wide with clamping, total height 70 mm

DI.SC.GK_PH80.110.00² mit großer Klammer, Preishalter 80 mm breit mit Klemmwirkung, Gesamthöhe 110 mm
with big clamp, price holder 80 mm wide with clamping, total height 110 mm



Bannerhalter mit Magnetbasis

Banner holder with magnetic base

L-Stange aus Aluminium, zwei transparente Clips
L-tube made of aluminium, two transparent hanging clips

Artikel-Nr. | Item no. **Länge | Length**

DI.BH.MS.250.06 250 mm



Blisterleisten

Display strips

600 mm lang, mit 12 Haken
600 mm long, with 12 hooks

Artikel-Nr. | Item no. **Ausführung | Description**

DI.BL.600.12H.TS.PP500¹ mit Topschild und Rundloch | with header and round hole

DI.BL.600.12H.TS.KN.PP² mit Topschild und Rundloch, knickbar | with header and round hole, bendable





Display-Artikel

Display accessories



Displayhaken

Display hooks

Kunststoff, weiß
plastic, white

Artikel-Nr. Item no.	Länge Length	Ausführung Description
DI.DH.K.EZ.70.01	70 mm	mit Klemme, Halterung Euro-Zunge with clamping, wide prong
DI.DH.K.EZ.100.01 ¹	100 mm	mit Klemme, Halterung Euro-Zunge with clamping, wide prong
DI.DH.K.EZ.120.01	120 mm	mit Klemme, Halterung Euro-Zunge with clamping, wide prong
DI.DH.K.EZ.150.01	150 mm	mit Klemme, Halterung Euro-Zunge with clamping, wide prong
DI.DH.K.EZ.170.01	170 mm	mit Klemme, Halterung Euro-Zunge with clamping, wide prong
DI.DH.KA.50.01 ³	50 mm	mit Klemme, Halterung schmaler Arm with clamping, single plastic prong
DI.DH.KA.100.01	100 mm	mit Klemme, Halterung schmaler Arm with clamping, single plastic prong
DI.DH.KA.150.01	150 mm	mit Klemme, Halterung schmaler Arm with clamping, single plastic prong
DI.DH.D.S.50.01 ⁴	50 mm	mit 3 Domen, Halterung Schlaufenhaken with automatic insertion hooks, double plastic prong
DI.DH.D.S.100.01	100 mm	mit 3 Domen, Halterung Schlaufenhaken with automatic insertion hooks, double plastic prong
DI.DH.D.S.150.01	150 mm	mit 3 Domen, Halterung Schlaufenhaken with automatic insertion hooks, double plastic prong
DI.DH.D.S.200.01	200 mm	mit 3 Domen, Halterung Schlaufenhaken with automatic insertion hooks, double plastic prong
DI.DH.D.S.250.01	250 mm	mit 3 Domen, Halterung Schlaufenhaken with automatic insertion hooks, double plastic prong
DI.DH.D.S.300.01	300 mm	mit 3 Domen, Halterung Schlaufenhaken with automatic insertion hooks, double plastic prong
DI.DH.D.A.50.01 ²	50 mm	mit 3 Domen, Halterung schmaler Arm with automatic insertion hooks, single plastic prong
DI.DH.D.A.100.01	100 mm	mit 3 Domen, Halterung schmaler Arm with automatic insertion hooks, single plastic prong
DI.DH.D.A.150.01	150 mm	mit 3 Domen, Halterung schmaler Arm with automatic insertion hooks, single plastic prong



Rückenstütze

Back support

Karton, 1,5 mm dick
cardboard, 1,5 mm thick

Artikel-Nr. Item no.	Format Size	Ausführung Description
DI.RS.A4.SK.01	für Inhalt DIN A4, 110 x 290 mm Back support for DIN A4, 110 x 290 mm	mit Selbstklebestreifen with self adhesive stripe

NEU
now in stock



Display-Artikel

Display accessories

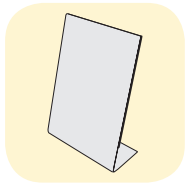

Prospekthalter L-Aufsteller

L-shaped sign holder

Polystyrol transparent
made of PS clear

Artikel-Nr. <i>Item no.</i>	Format <i>Size</i>	Ausführung <i>Description</i>	Materialstärke (ca.) <i>Material thickness (approx.)</i>
DI.A.L.DINLANG	DIN-lang, 101 x 215 mm <i>DL, 101 x 215 mm</i>	Fußbreite 65 mm, Hochformat <i>Base width 65 mm, vertical format</i>	1,5 mm
DI.A.L.A6	DIN A6, 106 x 151 mm <i>A6, 106 x 151 mm</i>	Fußbreite 44 mm, Hochformat <i>Base width 44 mm, vertical format</i>	1,5 mm
DI.A.L.A5	DIN A5, 149 x 212 mm <i>A5, 149 x 212 mm</i>	Fußbreite 50 mm, Hochformat <i>Base width 50 mm, vertical format</i>	1,5 mm
DI.A.L.A5.BS	DIN A5, 212 x 154 mm <i>A5, 212 x 154 mm</i>	Fußbreite 50 mm, Querformat <i>Base width 50 mm, horizontal format</i>	1,5 mm
DI.A.L.A4	DIN A4, 211 x 300 mm <i>A4, 211 x 300 mm</i>	Fußbreite 65 mm, Hochformat <i>Base width 65 mm, vertical format</i>	1,5 mm
DI.A.L.A4.BS	DIN A4, 299 x 214 mm <i>A4, 299 x 214 mm</i>	Fußbreite 70 mm, Querformat <i>Base width 70 mm, horizontal format</i>	1,5 mm
DI.A.L.A3	DIN A3, 299 x 445 mm <i>A3, 299 x 445 mm</i>	Fußbreite 105 mm, Hochformat <i>Base width 105 mm, vertical format</i>	2 mm

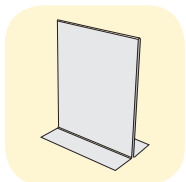

Prospekthalter T-Aufsteller

T-shaped sign holder

Polystyrol transparent, Materialstärke ca. 1,5 mm
made of PS clear, material thickness approx. 1.5 mm

Artikel-Nr. <i>Item no.</i>	Format <i>Size</i>	Ausführung <i>Description</i>
DI.A.T.DINLANG	DIN-lang, 101 x 212 mm <i>DL, 101 x 212 mm</i>	Fußbreite 84 mm, Hochformat <i>Base width 84 mm, vertical format</i>
DI.A.T.A6	DIN A6, 106 x 151 mm <i>A6, 106 x 151 mm</i>	Fußbreite 45 mm, Hochformat <i>Base width 45 mm, vertical format</i>
DI.A.T.A5	DIN A5, 149 x 212 mm <i>A5, 149 x 212 mm</i>	Fußbreite 84 mm, Hochformat <i>Base width 84 mm, vertical format</i>
DI.A.T.A5.BS	DIN A5, 212 x 154 mm <i>A5, 212 x 154 mm</i>	Fußbreite 72 mm, Querformat <i>Base width 72 mm, horizontal format</i>
DI.A.T.A4	DIN A4, 211 x 300 mm <i>A4, 211 x 300 mm</i>	Fußbreite 95 mm, Hochformat <i>Base width 95 mm, vertical format</i>
DI.A.T.A4.BS	DIN A4, 297 x 215 mm <i>A4, 297 x 215 mm</i>	Fußbreite 85 mm, Querformat <i>Base width 85 mm, horizontal format</i>

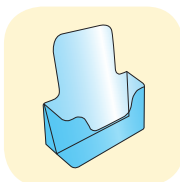

Displayständer

Brochure holder

Hochformat, Polystyrol transparent, Materialstärke ca. 2 mm
vertical format, PS clear, material thickness approx. 2 mm

Artikel-Nr. <i>Item no.</i>	Format <i>Size</i>	Fachbreite <i>Filling capacity</i>
DI.A.P.DINLANG	106 x 185 mm, für Inhalt DIN-lang <i>106 x 185 mm, for inserts DL</i>	27 mm
DI.A.P.DINLANG.4F ²	110 x 254 mm, 4 Fächer, für Inhalt DIN-lang, Hochformat <i>110 x 254 mm, 4 tier, for inserts DL, horizontal format</i>	158 mm
DI.A.P.DINLANG.6F	234 x 326 mm, 6 Fächer, für Inhalt DIN-lang, Hochformat <i>234 x 326 mm, 6 tier, for inserts DL, horizontal format</i>	161 mm
DI.A.P.A5	165 x 174 mm, für Inhalt DIN A5 <i>165 x 174 mm, for inserts A5</i>	34 mm
DI.A.P.A5.4F	172 x 254 mm, 4 Fächer, für Inhalt DIN A5 <i>172 x 254 mm, 4 tier, for inserts A5</i>	158 mm
DI.A.P.A4	234 x 250 mm, für Inhalt DIN A4 <i>234 x 250 mm, for inserts A4</i>	36 mm
DI.A.P.A4.3F ¹	234 x 318 mm, 3 Fächer, für Inhalt DIN A4 <i>234 x 318 mm, 3 tier, for inserts A4</i>	158 mm
DI.A.P.A4.4F	235 x 342 mm, 4 Fächer, für Inhalt DIN A4 <i>235 x 342 mm, 4 tier, for inserts A4</i>	175 mm



Display-Artikel Display accessories



Regalbodenhalter für Wellpappe-Displays

Shelf clips

2-teilig

2-parts

Artikel-Nr. Item no.	Format Size	Farbe Colour
SET.DI.RBH.059047.00 ¹	Aufnahme: 10 x 66 x 27 mm, Bodenhalterung: 59 x 47 mm bracket: 10 x 66 x 27 mm, carrier plate: 59 x 47 mm,	<input checked="" type="checkbox"/> transparent transparent
SET.DI.RBH.059047.01 ²	Aufnahme: 10 x 66 x 27 mm, Bodenhalterung: 59 x 47 mm bracket: 10 x 66 x 27 mm, carrier plate: 59 x 47 mm,	<input type="checkbox"/> weiß white



Gummischnüre, Kordeln & Bänder
Rubber bands, cords & ribbons





Rundgummi mit 2 Metallsplinten

Round elastic cords with 2 metal T-ends

elastisch, textilmflochten, ca. 2,2 mm dick, Metallsplinte mit eckigen Kanten
 elastic cords, textile-clad, approx. 2.2 mm thick, incl. metal T-ends

Artikel-Nr. Item no.	Länge Length	Farbe Colour
GZ.160.2.MS.01	160 mm	weiß white
GZ.160.2.MS.02	160 mm	schwarz black
GZ.160.2.MS.03	160 mm	rot red
GZ.160.2.MS.04	160 mm	mittelblau middle blue
GZ.160.2.MS.05	160 mm	dunkelblau dark blue
GZ.160.2.MS.07	160 mm	grün green
GZ.160.2.MS.11	160 mm	grau grey
GZ.180.2.MS.01	180 mm	weiß white
GZ.180.2.MS.02	180 mm	schwarz black
GZ.180.2.MS.03	180 mm	rot red
GZ.180.2.MS.04	180 mm	mittelblau middle blue
GZ.180.2.MS.05	180 mm	dunkelblau dark blue
GZ.180.2.MS.07	180 mm	grün green
GZ.180.2.MS.11	180 mm	grau grey
GZ.190.2.MS.01	190 mm	weiß white
GZ.190.2.MS.02	190 mm	schwarz black
GZ.190.2.MS.03	190 mm	rot red
GZ.190.2.MS.04	190 mm	mittelblau middle blue
GZ.190.2.MS.05	190 mm	dunkelblau dark blue
GZ.190.2.MS.07	190 mm	grün green
GZ.190.2.MS.11	190 mm	grau grey
GZ.230.2.MS.01	230 mm	weiß white
GZ.230.2.MS.02	230 mm	schwarz black
GZ.230.2.MS.03	230 mm	rot red
GZ.230.2.MS.04	230 mm	mittelblau middle blue
GZ.230.2.MS.05	230 mm	dunkelblau dark blue
GZ.230.2.MS.07	230 mm	grün green
GZ.230.2.MS.11	230 mm	grau grey
GZ.250.2.MS.01	250 mm	weiß white
GZ.250.2.MS.02	250 mm	schwarz black
GZ.250.2.MS.03	250 mm	rot red
GZ.250.2.MS.04	250 mm	mittelblau middle blue
GZ.250.2.MS.05	250 mm	dunkelblau dark blue
GZ.250.2.MS.07	250 mm	grün green
GZ.250.2.MS.11	250 mm	grau grey
GZ.270.2.MS.01	270 mm	weiß white
GZ.270.2.MS.02	270 mm	schwarz black
GZ.270.2.MS.03	270 mm	rot red
GZ.270.2.MS.04	270 mm	mittelblau middle blue
GZ.270.2.MS.05	270 mm	dunkelblau dark blue
GZ.270.2.MS.07	270 mm	grün green
GZ.270.2.MS.11	270 mm	grau grey



Gummischnüre, Kordeln & Bänder

Rubber bands, cords & ribbons



Artikel-Nr. Item no.	Länge Length	Farbe Colour
GZ.310.2.MS.01	310 mm	☐ weiß white
GZ.310.2.MS.02	310 mm	■ schwarz black
GZ.310.2.MS.03	310 mm	■ rot red
GZ.310.2.MS.04	310 mm	■ mittelblau middle blue
GZ.310.2.MS.05	310 mm	■ dunkelblau dark blue
GZ.310.2.MS.07	310 mm	■ grün green
GZ.310.2.MS.11	310 mm	■ grau grey
GZ.320.2.MS.01	320 mm	☐ weiß white
GZ.320.2.MS.02	320 mm	■ schwarz black
GZ.320.2.MS.03	320 mm	■ rot red
GZ.320.2.MS.04	320 mm	■ mittelblau middle blue
GZ.320.2.MS.05	320 mm	■ dunkelblau dark blue
GZ.320.2.MS.07	320 mm	■ grün green
GZ.320.2.MS.11	320 mm	■ grau grey
GZ.330.2.MS.01	330 mm	☐ weiß white
GZ.330.2.MS.02	330 mm	■ schwarz black
GZ.330.2.MS.03	330 mm	■ rot red
GZ.330.2.MS.04	330 mm	■ mittelblau middle blue
GZ.330.2.MS.05	330 mm	■ dunkelblau dark blue
GZ.330.2.MS.07	330 mm	■ grün green
GZ.330.2.MS.11	330 mm	■ grau grey
GZ.340.2.MS.01	340 mm	☐ weiß white
GZ.340.2.MS.02	340 mm	■ schwarz black
GZ.340.2.MS.03	340 mm	■ rot red
GZ.340.2.MS.04	340 mm	■ mittelblau middle blue
GZ.340.2.MS.05	340 mm	■ dunkelblau dark blue
GZ.340.2.MS.07	340 mm	■ grün green
GZ.340.2.MS.11	340 mm	■ grau grey
GZ.380.2.MS.01	380 mm	☐ weiß white
GZ.380.2.MS.02	380 mm	■ schwarz black
GZ.380.2.MS.03	380 mm	■ rot red
GZ.380.2.MS.04	380 mm	■ mittelblau middle blue
GZ.380.2.MS.05	380 mm	■ dunkelblau dark blue
GZ.380.2.MS.07	380 mm	■ grün green
GZ.380.2.MS.11	380 mm	■ grau grey
GZ.400.2.MS.01	400 mm	☐ weiß white
GZ.400.2.MS.02	400 mm	■ schwarz black
GZ.400.2.MS.03	400 mm	■ rot red
GZ.400.2.MS.04	400 mm	■ mittelblau middle blue
GZ.400.2.MS.05	400 mm	■ dunkelblau dark blue
GZ.400.2.MS.07	400 mm	■ grün green
GZ.400.2.MS.11	400 mm	■ grau grey
GZ.420.2.MS.01	420 mm	☐ weiß white
GZ.420.2.MS.02	420 mm	■ schwarz black
GZ.420.2.MS.03	420 mm	■ rot red
GZ.420.2.MS.04	420 mm	■ mittelblau middle blue
GZ.420.2.MS.05	420 mm	■ dunkelblau dark blue
GZ.420.2.MS.07	420 mm	■ grün green
GZ.420.2.MS.11	420 mm	■ grau grey







Gummischnüre, Kordeln & Bänder

Rubber bands, cords & ribbons



Rundgummi mit 2 Metallsplinten nach Kundenwunsch

Round elastic cords with 2 metal T-ends – customised

-  viele verschiedene Farben zur Auswahl (Farbkarte im Internet)
many different colours available (for colour chart see our online shop)
-  Länge nach Kundenvorgabe
customised length
-  andere Ausführungen auf Anfrage
different versions on request
-  Gummizugschnüre mit Metallsplinten aus 1,2 mm dünnem Rohmaterial
elastic cords with metal-ends made of 1.2 mm thin raw material
-  auch mit abgerundeten Splinten erhältlich
also available with rounded T-ends



Flachgummi mit 2 Metallsplinten

Flat elastic cords with 2 metal T-ends

elastisch, ca. 5 mm breit
elastic, approx. 5 mm wide



Artikel-Nr. Item no.	Länge Length	Farbe Colour
GZ.230.5.MS.01 ¹	230 mm	<input type="checkbox"/> weiß white
GZ.230.5.MS.02 ²	230 mm	<input checked="" type="checkbox"/> schwarz black
GZ.310.5.MS.01	310 mm	<input type="checkbox"/> weiß white
GZ.310.5.MS.02	310 mm	<input checked="" type="checkbox"/> schwarz black
GZ.340.5.MS.01	340 mm	<input type="checkbox"/> weiß white
GZ.340.5.MS.02	340 mm	<input checked="" type="checkbox"/> schwarz black



Gummizugschnüre mit Metallsplint zum Ring geschlossen

Elastic cord rings with metal ends

elastisch, textilumflochten, ca. 2,2 mm dick
elastic, textile-clad, approx. 2.2 mm diameter

Artikel-Nr. Item no.	Länge Length	Farbe Colour
GZ.410.2.R.01	410 mm	<input type="checkbox"/> weiß white
GZ.410.2.R.02	410 mm	<input checked="" type="checkbox"/> schwarz black
 GZ.410.2.R.03	410 mm	<input checked="" type="checkbox"/> rot red
 GZ.410.2.R.04	410 mm	<input checked="" type="checkbox"/> blau blue
 GZ.410.2.R.11	410 mm	<input checked="" type="checkbox"/> grau grey
GZ.410.2.R.13.A	410 mm	<input checked="" type="checkbox"/> gold gold
GZ.580.2.R.01	580 mm	<input type="checkbox"/> weiß white
GZ.580.2.R.02	580 mm	<input checked="" type="checkbox"/> schwarz black
GZ.580.2.R.06.A	580 mm	<input checked="" type="checkbox"/> silber silver
GZ.580.2.R.13.A	580 mm	<input checked="" type="checkbox"/> gold gold



Gummischnüre, Kordeln & Bänder

Rubber bands, cords & ribbons





Gummizugschnüre als Ring nach Kundenwunsch

Elastic cord rings - customised

mit Metallsplint, elastisch, textilumflochten, ca. 2,2 mm dick
with metal clip, textile-clad, approx. 2,2 mm thick

 viele verschiedene Farben zur Auswahl (Farbkarte im Internet)
many different colours available (for colour chart see our online shop)

 Länge nach Kundenvorgabe
customised length

 andere Ausführungen auf Anfrage, z.B. Tropfenform oder aus Flachgummi
different versions on request, e.g. drop shape or flat elastic cord



Rundgummi auf Rolle

Round elastic cords - on reels

elastisch, textilumspunnen
elastic, spun around a core

Artikel-Nr. Item no.	Durchmesser Diameter	Farbe Colour	Meter / Rolle Meters per roll
GZ.1_1.RL.350.06 ⁴	1 mm	silber silver	350 m
GZ.1_1.RL.350.13 ³	1 mm	gold gold	350 m
GZ.RL.1.01 ²	1 mm	weiß white	1050 m
GZ.RL.1.02 ¹	1 mm	schwarz black	1050 m
GZ.RL.1.03	1 mm	rot red	1050 m
GZ.RL.1.04	1 mm	mittelblau middle blue	1050 m
GZ.RL.1.07 ⁵	1 mm	dunkelgrün dark green	1050 m
GZ.RL.1.08	1 mm	gelb yellow	1050 m



elastisch, textilumflochten
elastic, textile-clad

Artikel-Nr. Item no.	Durchmesser Diameter	Farbe Colour	Meter / Rolle Meters per roll
GZ.RL.2.01	2,2 mm	weiß white	500 m
GZ.RL.2.02	2,2 mm	schwarz black	500 m
GZ.RL.2.03	2,2 mm	rot red	500 m
GZ.RL.2.04	2,2 mm	mittelblau middle blue	500 m
GZ.RL.2.450.06	2 mm	silber silver	450 m
GZ.RL.2.07	2,2 mm	dunkelgrün dark green	500 m
GZ.RL.2.08	2,2 mm	gelb yellow	500 m
GZ.RL.2.09	2,2 mm	orange orange	500 m
GZ.RL.2.11	2,2 mm	hellgrau light grey	500 m
GZ.RL.2.450.13	2 mm	gold gold	450 m
GZ.RL.2.14	2,2 mm	bordeaux-rot bordeaux-red	500 m
GZ.RL.2.17	2,2 mm	braun brown	500 m



Flachgummi auf Rolle

Flat elastic cords on reel

elastisch , textilumflochten
elastic, textile-clad

Artikel-Nr. Item no.	Meter / Rolle Meters per roll	Breite Width	Farbe Colour
GZ.RL.5.01	500 m	5 mm	☐ weiß white
GZ.RL.5.02	500 m	5 mm	■ schwarz black
GZ.RL.5.03	500 m	5 mm	■ rot red
GZ.RL.5.04 ¹	500 m	5 mm	■ blau blue
GZ.RL.5.07	500 m	5 mm	■ grün green
GZ.RL.5.08	500 m	5 mm	■ gelb yellow
GZ.RL.5.09	500 m	5 mm	■ orange orange
GZ.RL.5.11	500 m	5 mm	■ grau grey
GZ.RL.5.14	500 m	5 mm	■ bordeaux-rot bordeaux-red
GZ.RL.5.17	500 m	5 mm	■ braun brown
NEU GZ.RL.10.01	100 m	10 mm	☐ weiß white
NEU GZ.RL.10.02	100 m	10 mm	■ schwarz black
NEU GZ.RL.15.01	100 m	15 mm	☐ weiß white
NEU GZ.RL.15.02	100 m	15 mm	■ schwarz black



Fertigschleifen mit Metallsplint

Cord loops with metal clip

Baumwolle, nicht elastisch, ca. 1 mm dick, weiß
cotton, not elastic, material thickness approx. 1 mm, white

Artikel-Nr. Item no.	Länge bis Knoten Length to knot
K0.160.1.FS.MS.01	ca. 80 / 160 mm
K0.240.1.FS.MS.01	ca. 120 / 240 mm
K0.320.1.FS.MS.01	ca. 160 / 320 mm



Gummischnüre, Kordeln & Bänder

Rubber bands, cords & ribbons



Fertigschleifen aus Gummizugschnur

Elastic cord loops with knot

elastisch, umspinnen, ca. 1 mm dick
elastic, covered cord, approx. 1 mm thick

Artikel-Nr. Item no.	Länge bis Knoten Length to knot	Farbe Colour
GZ.80.1.FS.H.01	40 / 80 mm	<input type="checkbox"/> weiß white
GZ.80.1.FS.H.02	40 / 80 mm	<input checked="" type="checkbox"/> schwarz black
GZ.80.1.FS.H.06	40 / 80 mm	<input type="checkbox"/> silber silver
GZ.80.1.FS.H.13	40 / 80 mm	<input checked="" type="checkbox"/> gold gold
GZ.120.1.FS.H.01	60 / 120 mm	<input type="checkbox"/> weiß white
GZ.120.1.FS.H.02	60 / 120 mm	<input checked="" type="checkbox"/> schwarz black
GZ.120.1.FS.H.06	60 / 120 mm	<input type="checkbox"/> silber silver
GZ.120.1.FS.H.13	60 / 120 mm	<input checked="" type="checkbox"/> gold gold
NEU GZ.140.1.FS.H.01	70 / 140 mm	<input type="checkbox"/> weiß white
NEU GZ.140.1.FS.H.02	70 / 140 mm	<input checked="" type="checkbox"/> schwarz black
NEU GZ.140.1.FS.H.06	70 / 140 mm	<input type="checkbox"/> silber silver
NEU GZ.140.1.FS.H.13	70 / 140 mm	<input checked="" type="checkbox"/> gold gold
NEU GZ.160.1.FS.H.01	80 / 160 mm	<input type="checkbox"/> weiß white
NEU GZ.160.1.FS.H.02	80 / 160 mm	<input checked="" type="checkbox"/> schwarz black
NEU GZ.160.1.FS.H.06	80 / 160 mm	<input type="checkbox"/> silber silver
NEU GZ.160.1.FS.H.13	80 / 160 mm	<input checked="" type="checkbox"/> gold gold
GZ.180.1.FS.H.01	90 / 180 mm	<input type="checkbox"/> weiß white
GZ.180.1.FS.H.02	90 / 180 mm	<input checked="" type="checkbox"/> schwarz black
GZ.180.1.FS.H.06	90 / 180 mm	<input type="checkbox"/> silber silver
GZ.180.1.FS.H.13	90 / 180 mm	<input checked="" type="checkbox"/> gold gold
GZ.200.1.FS.H.01	100 / 200 mm	<input type="checkbox"/> weiß white
GZ.200.1.FS.H.02	100 / 200 mm	<input checked="" type="checkbox"/> schwarz black
GZ.200.1.FS.H.06	100 / 200 mm	<input type="checkbox"/> silber silver
GZ.200.1.FS.H.13	100 / 200 mm	<input checked="" type="checkbox"/> gold gold
NEU GZ.250.1.FS.H.01	125 / 250 mm	<input type="checkbox"/> weiß white
NEU GZ.250.1.FS.H.02	125 / 250 mm	<input checked="" type="checkbox"/> schwarz black
NEU GZ.250.1.FS.H.06	125 / 250 mm	<input type="checkbox"/> silber silver
NEU GZ.250.1.FS.H.13	125 / 250 mm	<input checked="" type="checkbox"/> gold gold
GZ.300.1.FS.H.01	150 / 300 mm	<input type="checkbox"/> weiß white
GZ.300.1.FS.H.02	150 / 300 mm	<input checked="" type="checkbox"/> schwarz black
GZ.300.1.FS.H.06	150 / 300 mm	<input type="checkbox"/> silber silver
GZ.300.1.FS.H.13	150 / 300 mm	<input checked="" type="checkbox"/> gold gold
GZ.400.1.FS.H.01	200 / 400 mm	<input type="checkbox"/> weiß white
GZ.400.1.FS.H.02	200 / 400 mm	<input checked="" type="checkbox"/> schwarz black
GZ.400.1.FS.H.06	200 / 400 mm	<input type="checkbox"/> silber silver
GZ.400.1.FS.H.13	200 / 400 mm	<input checked="" type="checkbox"/> gold gold







Gummischnüre, Kordeln & Bänder Rubber bands, cords & ribbons



Fertigschleifen maschinell an Anhängerkarten geknotet Elastic cord loops with knot on hang tag-machine-made





1 mm dick
1 mm thick

-  elastisch oder unelastisch
elastic or inelastic
-  schwarz, weiß, silber, gold oder farbig
black, white, silver, gold or coloured
-  von 40 / 80 mm bis 200 / 400 mm nach Kundenvorgabe gefertigt
from 40 / 80 mm up to 200 / 400 mm, customised
-  mit oder ohne Metallöse
with or without metal eyelet
-  andere Ausführungen und Farben auf Anfrage
other versions and colours on request



Abschnitte aus Gummizugschnur Elastic cords, cut-to-length

elastisch
elastic

-  Rund- oder Flachgummi in verschiedenen Durchmessern und Breiten
round- or flat elastic cord in different diameters and widths
-  schwarz, weiß, silber, gold oder farbig
black, white, silver, gold or coloured
-  Länge nach Kundenvorgabe
customer-specified length
-  andere Ausführungen und Farben auf Anfrage, auch heiß geschnitten möglich
other versions and colours on request, hot cutting is also available



Lederkordel auf Rolle Leather cord on reel

Artikel-Nr. Item no.	Durchmesser Diameter	Meter / Rolle Meters per roll
KO.RLL.5.02.25	5 mm	25 m
KO.RLL.6.02.50	6 mm	50 m



Gummischnüre, Kordeln & Bänder

Rubber bands, cords & ribbons



Atlaskordeln auf Rolle

Cords on reel

2-fach gedreht, ca. 2 mm dick, aus Viskose

double-twisted, approx. 2 mm thick, viscose

Artikel-Nr. Item no.	Farbe Colour	Meter / Rolle Meters per roll
KO.RL.2.01	☐ weiß white	100 m
KO.RL.2.02	■ schwarz black	100 m
KO.RL.2.03	■ rot red	100 m
KO.RL.2.04	■ mittelblau mid blue	100 m
KO.RL.2.05	■ dunkelblau dark blue	100 m
KO.RL.2.06	■ silbergrau silver grey	100 m
KO.RL.2.07	■ grün green	100 m
KO.RL.2.07	■ dunkelgrün dark green	100 m
KO.RL.2.08 ¹	■ gelb yellow	100 m
KO.RL.2.09	■ orange orange	100 m
KO.RL.2.13	■ gold gold	100 m
KO.RL.2.14	■ bordeaux-rot bordeaux-red	100 m
KO.RL.2.17	■ braun brown	100 m
KO.RL.2.18	■ beige beige	100 m



Kordelklammern

Cord clips

Metallsplint zur Fertigung als Ring, vernickelt

metal t-ends for ring production, nickel-plated

Artikel-Nr. Item no.	Format Size
KO.MS.R.9.6_3.10_2.06	9 x 6,3 x 10,2 mm
KO.MS.R.20.16.21.06	20 x 16 x 21 mm
KO.MS.R.20_5.11_5.13.06 ¹	20,5 x 11,5 x 13 mm
KO.MS.R.22_3.9_2.12_8.06	22,3 x 9,2 x 12,8 mm
KO.MS.R.30.11.14_2.06	30 x 11 x 14,2 mm
KO.MS.R.30_5.18.24_5.06	30,5 x 18 x 24,5 mm

Metallsplint zur Fertigung mit 2 Splinten, vernickelt

metal t-ends for production with two t-ends, nickel-plated

Artikel-Nr. Item no.	Format Size
KO.MS.T.15.3_3.4_7.06	15 x 3,3 x 4,7 mm
KO.MS.T.15_4.6_3.6_5.06	15,4 x 6,3 x 6,5 mm
KO.MS.T.24_6.3_7.3_6.06 ²	24,6 x 3,7 x 3,6 mm
KO.MS.T.28.6_5.7.06	28 x 6,5 x 7 mm
KO.MS.T.39.10.14_5.06 ³	39 x 10 x 14,5 mm





Gummischnüre, Kordeln & Bänder

Rubber bands, cords & ribbons



Kordeln mit Splinten

Braided cords with hooks

geflochten, ca. 5 mm dick
braided, approx. 5 mm thick

Artikel-Nr. Item no.	Farbe Colour	Länge von Splint zu Splint Length from film hook to film hook
KO.450.5.FOS.01	<input type="checkbox"/> weiß white	450 mm
KO.450.5.FOS.02	<input checked="" type="checkbox"/> schwarz black	450 mm
KO.800.5.FOS.01	<input type="checkbox"/> weiß white	800 mm
KO.800.5.FOS.02	<input checked="" type="checkbox"/> schwarz black	800 mm

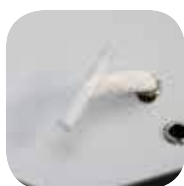

Lesezeichenband

Page marking ribbon





ca. 4-5 mm breit
approx. 4-5 mm wide

Artikel-Nr. Item no.	Farbe Colour	Meter / Rolle Meters per roll
ZL.RL.01_01	<input type="checkbox"/> weiß white	600 m
ZL.RL.02_105	<input checked="" type="checkbox"/> schwarz black	600 m
ZL.RL.03_24	<input checked="" type="checkbox"/> rot red	600 m
ZL.RL.04_07	<input checked="" type="checkbox"/> hellblau light blue	600 m
ZL.RL.04_53	<input checked="" type="checkbox"/> blau blue	600 m
ZL.RL.06_97	<input checked="" type="checkbox"/> silbergrau silver grey	600 m
ZL.RL.07_19	<input checked="" type="checkbox"/> grasgrün green	600 m
ZL.RL.07_71	<input checked="" type="checkbox"/> dunkelgrün dark green	600 m
ZL.RL.08_15	<input checked="" type="checkbox"/> gelb yellow	600 m
ZL.RL.09_117	<input checked="" type="checkbox"/> orange orange	600 m
ZL.RL.13_11	<input checked="" type="checkbox"/> gold gold	600 m



Abschnitte Lesezeichenband und Kordeln nach Kundenwunsch

Parts page marking ribbon and cords - customised

-  viele verschiedene Farben zur Auswahl
many different colours available
-  Länge nach Kundenwunsch
customised length
-  Kordeln auch mit Splinten und in verschiedenen Durchmessern
cords also available with metal ends and in different diameters
-  andere Ausführungen auf Anfrage
different versions on request



Gummiringe

Rubber bands

rot
red

Artikel-Nr. Item no.	Durchmesser Diameter	Stück / kg Pieces / Kg
GR.20.03.1KG	20 mm	8.300
GR.40.03.1KG	40 mm	4.500
GR.50.03.1KG	50 mm	3.100
GR.60.03.1KG	60 mm	2.300
GR.80.03.1KG	80 mm	2.000
GR.100.03.1KG	100 mm	1.100



Klemmschienen & Posterschienen
Slide binders & poster hanging rail sets





Klemmschienen & Posterschienen

Slide binders & poster hanging rail sets

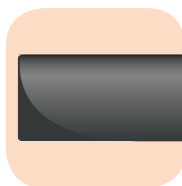
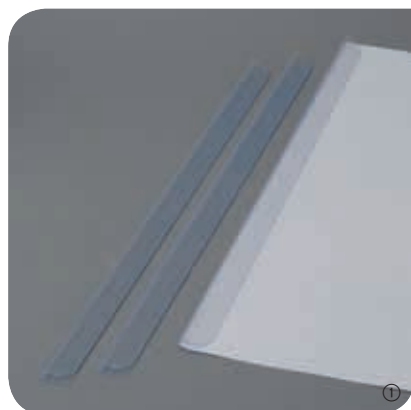

Klemmschienen

Slide binders

Kunststoff, zum Binden von losen Blättern

rigid-PVC, to bind loose sheets

Artikel-Nr. Item no.	Länge Length	max. Füllhöhe max filling level	Farbe Colour
KS.210.34.00	DIN A5, 210 mm	3-4 mm	☐ transparent transparent
KS.210.34.01	DIN A5, 210 mm	3-4 mm	☐ weiß white
KS.210.34.02	DIN A5, 210 mm	3-4 mm	■ schwarz black
KS.297.34.00 ¹	DIN A4, 297 mm	3-4 mm	☐ transparent transparent
KS.297.34.01 ³	DIN A4, 297 mm	3-4 mm	☐ weiß white
KS.297.34.02 ²	DIN A4, 297 mm	3-4 mm	■ schwarz black
KS.297.34.03 ⁴	DIN A4, 297 mm	3-4 mm	■ rot red
KS.297.34.04 ⁵	DIN A4, 297 mm	3-4 mm	■ blau blue
KS.297.34.05	DIN A4, 297 mm	3-4 mm	■ dunkelblau dark blue
KS.297.56.00	DIN A4, 297 mm	5-6 mm	☐ transparent transparent
KS.297.56.01	DIN A4, 297 mm	5-6 mm	☐ weiß white
KS.297.56.02	DIN A4, 297 mm	5-6 mm	■ schwarz black
KS.297.78.00	DIN A4, 297 mm	7-8 mm	☐ transparent transparent
KS.297.78.01	DIN A4, 297 mm	7-8 mm	☐ weiß white
KS.297.78.02	DIN A4, 297 mm	7-8 mm	■ schwarz black
KS.297.910.00	DIN A4, 297 mm	9-10 mm	☐ transparent transparent
KS.297.910.01	DIN A4, 297 mm	9-10 mm	☐ weiß white
KS.297.910.02	DIN A4, 297 mm	9-10 mm	■ schwarz black
PK.420.0.00	DIN A3, 420 mm	3-4 mm	☐ transparent transparent
PK.420.0.01 ⁶	DIN A3, 420 mm	3-4 mm	☐ weiß white
PK.420.0.02	DIN A3, 420 mm	3-4 mm	■ schwarz black

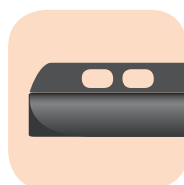

Klemmschienen mit Abheffahne

Slide binders with filing strip

Kunststoff, zum Binden von losen Blättern

rigid-PVC, to bind loose sheets

Artikel-Nr. Item no.	Länge Length	max. Füllhöhe max filling level	Farbe Colour
KS.297.34.AF.00	DIN A4, 297 mm	3-4 mm	☐ transparent transparent
KS.297.34.AF.02 ¹	DIN A4, 297 mm	3-4 mm	■ schwarz black
KS.297.56.AF.00	DIN A4, 297 mm	5-6 mm	☐ transparent transparent



Klemmschienen & Posterschienen

Slide binders & poster hanging rail sets

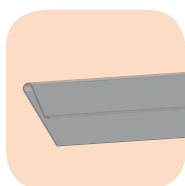
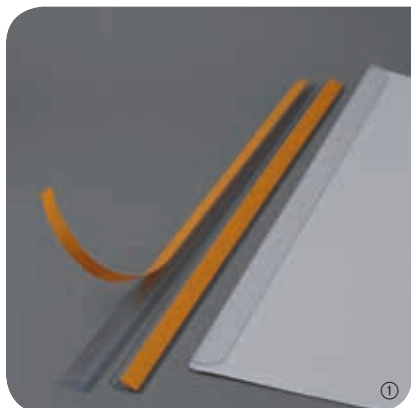

Klemmschienen, selbstklebend

Slide Binders, self-adhesive

Kunststoff, zum Binden von losen Blättern

rigid-PVC, to bind loose sheets

Artikel-Nr. Item no.	Länge Length	max. Füllhöhe max filling level	Farbe Colour
KS.50.1.SK.00	50 mm	1 mm	☐ transparent transparent
KS.210.1.SK.00	DIN A5, 210 mm	1 mm	☐ transparent transparent
KS.297.1.SK.00	DIN A4, 297 mm	1 mm	☐ transparent transparent
KS.297.34.SK.00 ¹	DIN A4, 297 mm	3-4 mm	☐ transparent transparent
KS.297.56.SK.00	DIN A4, 297 mm	5-6 mm	☐ transparent transparent
KS.550.1.SK.00	550 mm	1 mm	☐ transparent transparent
KS.1000.1.SK.00	1000 mm	1 mm	☐ transparent transparent



Klemmschienenhüllen

Slide binder covers

PP-Folie 110 µm transparent genarbt

PP foil 110 micron, orange peel, transparent

Artikel-Nr. Item no.	Format Size
KS.H.PP011	DIN A4



Klemmschienen nach Kundenwunsch

Slide binders - customised

-  Mindestmenge: 250 Stück
minimum quantity: 250 pieces
-  Sonderlängen in fast jeder gewünschten Abmessung
custom-made in all desired lengths
-  Sonderfarben, z.B. grün, gelb, grau, etc.
special colours, e.g. green, yellow, grey, etc.
-  verschiedene Füllhöhen und Breiten
different filling levels and widths
-  auf Wunsch selbstklebend ausgestattet
self-adhesive on request
-  mit oder ohne Abheftfahne
with or without filing strip



Klemmschienen & Posterschienen

Slide binders & poster hanging rail sets

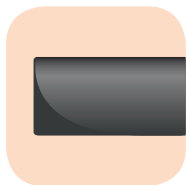
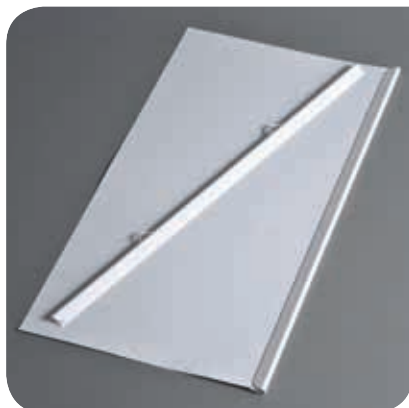

Posterklemmschienen

Poster hanging rail sets

Hart-PVC, 13 mm breit, bestehend aus einer Oberschiene mit Aufhänger und einer Unterschiene ohne Aufhänger

rigid-PVC, width 13 mm, consisting of upper rail with hanger and bottom rail without hanger

Artikel-Nr. Item no.	Länge Length	Aufhänger No. of hangers	Farbe Colour
SET.PK.210.1.00	210 mm	1 Aufhänger 1 hanger	☐ transparent transparent
SET.PK.297.1.00	297 mm	1 Aufhänger 1 hanger	☐ transparent transparent
SET.PK.400.2.00	400 mm	2 Aufhänger 2 hanger	☐ transparent transparent
SET.PK.420.1.00	420 mm	1 Aufhänger 1 hanger	☐ transparent transparent
SET.PK.420.2.00	420 mm	2 Aufhänger 2 hanger	☐ transparent transparent
SET.PK.420.2.01	420 mm	2 Aufhänger 2 hanger	☐ weiß white
SET.PK.420.2.02	420 mm	2 Aufhänger 2 hanger	■ schwarz black
SET.PK.500.2.00	500 mm	1 Aufhänger 1 hanger	☐ transparent transparent
SET.PK.594.1.00	594 mm	1 Aufhänger 1 hanger	☐ transparent transparent
SET.PK.594.2.00	594 mm	2 Aufhänger 2 hanger	☐ transparent transparent
SET.PK.594.2.01	594 mm	2 Aufhänger 2 hanger	☐ weiß white
SET.PK.594.2.02	594 mm	2 Aufhänger 2 hanger	■ schwarz black
SET.PK.600.2.00	600 mm	2 Aufhänger 2 hanger	☐ transparent transparent
SET.PK.700.2.00	700 mm	2 Aufhänger 2 hanger	☐ transparent transparent
SET.PK.800.2.00	800 mm	2 Aufhänger 2 hanger	☐ transparent transparent
SET.PK.841.2.00	841 mm	2 Aufhänger 2 hanger	☐ transparent transparent
SET.PK.841.2.01	841 mm	2 Aufhänger 2 hanger	☐ weiß white
SET.PK.841.2.02	841 mm	2 Aufhänger 2 hanger	■ schwarz black
SET.PK.900.2.00	900 mm	2 Aufhänger 2 hanger	☐ transparent transparent
SET.PK.1000.2.00	1000 mm	2 Aufhänger 2 hanger	☐ transparent transparent
SET.PK.1200.2.00	1200 mm	2 Aufhänger 2 hanger	☐ transparent transparent



Klemmschienen & Posterschienen

Slide binders & poster hanging rail sets

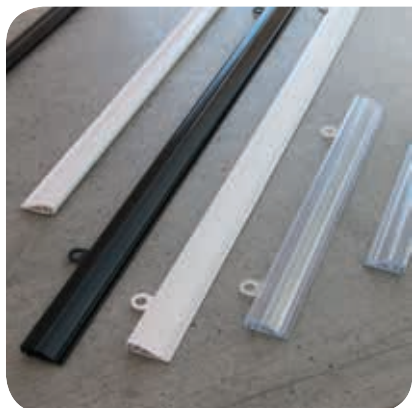

Posterklemmschienen, aufklappbar

Poster hanging rail sets with clamping

Hart-PVC, bestehend aus Oberschiene mit zwei Aufhängern (beiliegend) und Unterschiene ohne Aufhänger

rigid-PVC, consisting of upper rail with two hangers (loose inserted) and bottom rail without hanger

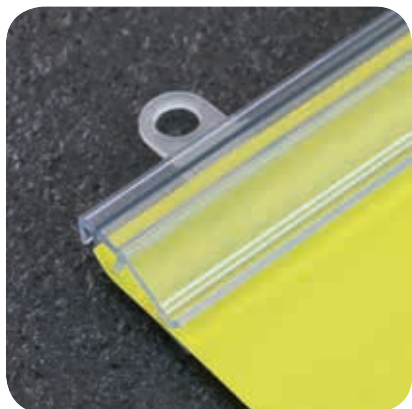
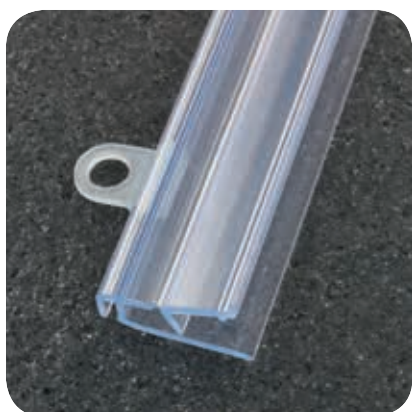

Artikel-Nr. Item no.	Länge Length	Breite Width	Farbe Colour
SET.PK.210.KL.00	210 mm	20 mm	☐ transparent transparent
SET.PK.297.KL.00	297 mm	20 mm	☐ transparent transparent
SET.PK.420.KL.00	420 mm	20 mm	☐ transparent transparent
SET.PK.420.KL.01	420 mm	20 mm	☐ weiß white
SET.PK.420.KL.02	420 mm	20 mm	■ schwarz black
SET.PK.500.KL.00	500 mm	20 mm	☐ transparent transparent
SET.PK.594.KL.00	594 mm	20 mm	☐ transparent transparent
SET.PK.594.KL.01	594 mm	20 mm	☐ weiß white
SET.PK.594.KL.02	594 mm	20 mm	■ schwarz black
SET.PK.700.KL.00	700 mm	20 mm	☐ transparent transparent
SET.PK.800.KL.00	800 mm	20 mm	☐ transparent transparent
SET.PK.841.KL.00	841 mm	20 mm	☐ transparent transparent
SET.PK.841KL.01	841 mm	20 mm	☐ weiß white
SET.PK.841.KL.02	841 mm	20 mm	■ schwarz black
SET.PK.900.KL.00	900 mm	20 mm	☐ transparent transparent
SET.PK.1000.KL.00	1000 mm	20 mm	☐ transparent transparent
SET.PK.1200.KL.00	1200 mm	20 mm	☐ transparent transparent



Klemmschienen & Posterschienen

Slide binders & poster hanging rail sets



Posterklemmschienen Aluminium

Slide binders

silber eloxiert, 26 mm breit, bestehend aus einer Oberschiene mit 2 Aufhängern und einer Unterschiene ohne Aufhänger, aufklappbar mit Endkappen und Anti-Rutschgummi
silver anodised, 26 mm wide, upper rail with 2 hangers, bottom rail without hanger, with end caps and anti-slip rubber

Artikel-Nr. | Item no. Länge | Length

PK.ALU.210.06 210 mm

PK.ALU.297.06 297 mm

PK.ALU.420.06 420 mm

PK.ALU.500.06 500 mm

PK.ALU.594.06 594 mm

PK.ALU.700.06 700 mm

PK.ALU.800.06 800 mm

PK.ALU.841.06 841 mm

PK.ALU.900.06 900 mm

PK.ALU.1000.06 1000 mm

PK.ALU.1200.06 1200 mm

Posterklemmschienen nach Kundenwunsch

Poster hanging rail sets - customised



Mindestmenge: 50 Paar
minimum quantity: 50 pairs



Sonderlängen in fast jeder gewünschten Abmessung
custom-made in all desired lengths



Sonderfarben, z.B. weiß, rot, blau, grün, gelb, grau, etc.
special colours, e.g. white, red, blue, green, yellow, grey, etc.



mit oder ohne Aufhänger
with or without hangers



mit Kordel als Aufhänger
with cord as hanger





Hüllen für Schutz & Präsentation
Covers for protection & presentation





Hüllen für Schutz & Präsentation

Covers for protection & presentation

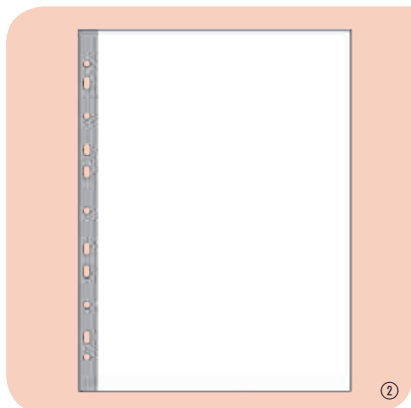

Prospekthüllen / Ablagehüllen

Sheet protectors

transparent, mit Abheftrand

transparent, with punched filing strip

Artikel-Nr. Item no.	Format Size	Ausführung Description	Folienstärke Foil thickness	Material Material
PH.US.WPVC014	für US-Letter-Format for US-letter format	Schmalseite offen, 5-fach gelocht short edge open, 5-on-1 hole	140 µm 140 micron	Weich-PVC soft-PVC
PH.A6.WPVC018 ¹	für Inhalt DIN A6 for A6	Schmalseite offen, 2-fach gelocht short edge open, 2-on-1 hole	180 µm 180 micron	Weich-PVC soft-PVC
PH.A5.WPVC018 ³	für Inhalt DIN A5 for A5	Schmalseite offen, 2-fach gelocht short edge open, 2-on-1 hole	180 µm 180 micron	Weich-PVC soft-PVC
PH.A5.PP60.GN	für Inhalt DIN A5 for A5	Schmalseite offen, 7-fach gelocht, genarbt short edge open, 7-on-1 hole, grained	60 µm 60 micron	PP-Folie PP foil
PH.A4.WPVC018	für Inhalt DIN A4 for A4	Schmalseite offen, 4-fach gelocht short edge open, 4-on-1 hole	180 µm 180 micron	Weich-PVC soft-PVC
PH.A4.PP80.GN ²	für Inhalt DIN A4 for A4	Schmalseite offen, 11-fach gelocht, genarbt for A4, short edge open, 11-on-1 hole, grained	80 µm 80 micron	PP-Folie PP foil
PH.A4.PP55.GN ²	für Inhalt DIN A4 for A4	Schmalseite offen, 11-fach gelocht, genarbt short edge open, 11-on-1 hole, grained	55 µm 55 micron	PP-Folie PP foil

Prospekthüllen aus PP-Folie zum Einbinden in Draht- und Plastikbinderücken

PP foil protective covers for filing in wire or plastic spine binding systems

Artikel-Nr. Item no.	Format Size	Ausführung Description	Folienstärke Foil thickness	Material Material
PH.A4.UG.PP011	für Inhalt DIN A4 for A4	Schmalseite offen, ungelocht short edge open, unperforated	110 µm 110 micron	PP-Folie PP foil
PH.A4.UG.PP012.GN	für Inhalt DIN A4 for A4	Schmalseite offen, ungelocht, genarbt short edge open, unperforated, grained	120 µm 120 micron	PP-Folie PP foil

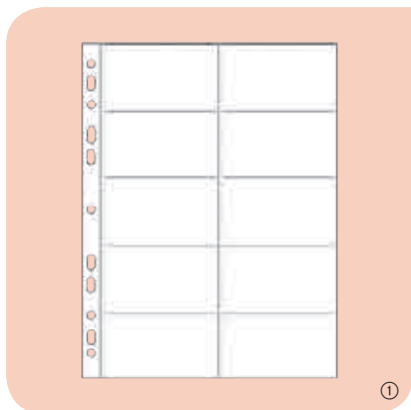

Ablagehüllen aus PP-Folie

PP foil protective covers

PP-Folie 11-fach gelocht

PP foil 11-on-1 hole

Artikel-Nr. Item no.	Ausführung Description
PH.A4.10VK.PP010 ¹	für 10 Visitenkarten oder Scheckkarten for 10 business cards or credit cards
PH.A4.15X050050.PP012 ²	für 15 gerahmte Dias for 15 framed slides
PH.A4.4X100150.PP010	für 4 Fotos Querformat 10 x 15 cm for 4 photos (landscape) 10 x 15 cm
PH.A4.4X130180.PP010	für 4 Fotos Querformat 13 x 18 cm for 4 photos (landscape) 13 x 18 cm
PH.A4.8X090130.PP010	für 8 Fotos Hochformat 9 x 13 cm for 8 photos (portrait) 9 x 13 cm
PH.A4.8X100150.PP010 ³	für 8 Postkarten Hochformat 10 x 15 cm for 8 postcards (portrait) 10 x 15 cm
PH.A4.FH.ES.PP018	für Inhalt DIN A4, mit Füllhöhe für voluminösen Inhalt for A4, with filling level for voluminous contents











Hüllen für Schutz & Präsentation

Covers for protection & presentation



Prospekthüllen nach Kundenwunsch

sheet protectors – customised

-  Mindestmenge: 250 Stück
minimum quantity: 250 pieces
-  Sonderformate in fast jeder gewünschten Abmessung
custom-made in nearly all desired sizes
-  Schmalseite oder Breitseite offen
short edge open or long edge open
-  verschiedene Folienarten, Folienstärken und Folienfarben, z.B. glasklar, matt, transluzent oder farbig
available in different foil types, thicknesses and colours, e.g. transparent, frosted, translucent or coloured
-  Abschweißungen / Aufschweißungen für mehrere Taschen
multiple pockets / welded on pockets
-  Abheftrand mit 2-fach, 4-fach oder kundenspezifischer Lochung
punched filing strip with 2-on-1, 4-on-1 or customised punched holes
-  auf Wunsch mit Klappe (auch mit Klettband oder Laschenverschluss)
with flap on request (also available with hook and loop fasteners or flap fastener)
-  Aufdrucke im Siebdruck, Offsetdruck oder mit (Blind)-Prägung
overprint with silk screen printing, offset printing or with (blind) embossing

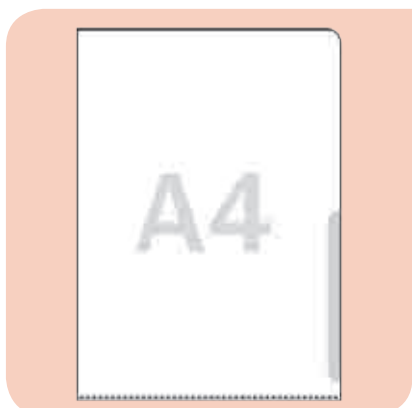

Sichthüllen, unbedruckt

L-Folders – unprinted

für Inhalt DIN A4, oben und rechts offen, mit Griffaussparung, Ecke oben rechts gerundet
for A4, top and right edge open, upper right corner rounded

Artikel-Nr. <i>Item no.</i>	Folienstärke <i>Foil thickness</i>	Material <i>Material</i>
SH.A4.HPVC015	150 µm 150 micron	Hart-PVC, transparent glasklar <i>rigid-PVC, transparent</i>
SH.A4.PP012	120 µm 120 micron	PP-Folie, transparent genarbt <i>PP foil, transparent grained</i>
SH.A4.PP015	150 µm 150 micron	PP-Folie, transparent leicht genarbt <i>PP foil, transparent lightly grained</i>
SH.A4.PP016	160 µm 160 micron	PP-Folie, transparent glatt <i>PP foil, transparent smooth</i>

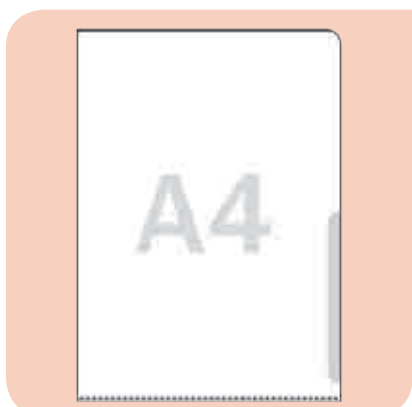

Sichthüllen, bedruckt

L-Folders – printed

für Inhalt DIN A4, oben und rechts offen, mit Daumenaussparung, Ecke oben rechts gerundet, mit Sieb- oder Offsetdruck individualisiert
for insert A4, top and right edge open, upper right corner rounded, customized with silk screen printing or offset printing

Artikel-Nr. <i>Item no.</i>	Folienstärke <i>Foil thickness</i>	Material <i>Material</i>	Druck <i>Print</i>
SH.A4.PP016.OFFSET ¹	160 µm 160 micron	PP-Folie, transparent, glatt <i>PP foil, transparent, smooth</i>	Offset, 4-farbig <i>4-colour offset printing</i>
SH.A4.PP020.OFFSET	200 µm 200 micron	PP-Folie, transparent, glatt <i>PP foil, transparent, smooth</i>	Offset, 4-farbig <i>4-colour offset printing</i>
SH.A4.PP012.SIEBDRUCK	120 µm 120 micron	PP-Folie, transparent, genarbt <i>PP foil, transparent, grained</i>	Siebdruck, 1-4 farbig <i>1 to 4-colour silk screen printing</i>
SH.A4.PP015.SIEBDRUCK ²	150 µm 150 micron	PP-Folie, transparent, leichtgenarbt <i>PP foil, transparent, slightly grained</i>	Siebdruck, 1-4 farbig <i>1 to 4-colour silk screen printing</i>
SH.A4.PP016.SIEBDRUCK	160 µm 160 micron	PP-Folie, transparent, glatt <i>PP foil, transparent, smooth</i>	Siebdruck, 1-4 farbig <i>1 to 4-colour silk screen printing</i>
SH.A4.HPVC015.SIEBDRUCK	150 µm 150 micron	PP-Folie, transparent, klar <i>PP foil, transparent, clear</i>	Siebdruck, 1-4 farbig <i>1 to 4-colour silk screen printing</i>





Hüllen für Schutz & Präsentation

Covers for protection & presentation

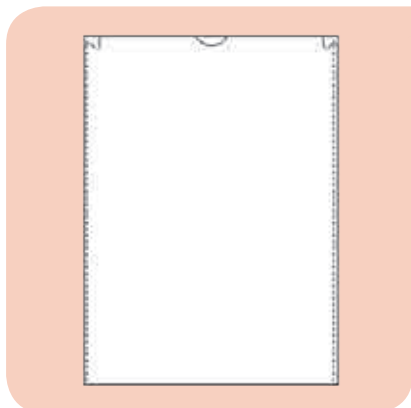

Schutzhüllen

Protective covers

Schmalseite offen, mit Daumenausparung, transparent

short edge open, with thumb slot, transparent

Artikel-Nr. Item no.	Format Size	Folienstärke Foil thickness	Material Material
SZ.DINLANG.SS.PP012	für Inhalt DIN-lang for DL	120 µm 120 micron	PP-Folie PP foil
SZ.A7.SS.DA.ES.PP012	für Inhalt DIN A7 for A7	120 µm 120 micron	PP-Folie PP foil
SZ.A6.SS.DA.ES.PP012	für Inhalt DIN A6 for A6	120 µm 120 micron	PP-Folie PP foil
SZ.A5.SS.DA.ES.PP012	für Inhalt DIN A5 for A5	120 µm 120 micron	PP-Folie PP foil
SZ.148.210.DA.ES.PP016	für Inhalt DIN A5 for A5	160 µm 160 micron	PP-Folie PP foil
NEU SZ.210.297.DA.ES.PP016.GN	Außenformat DIN A4 external format A4	160 µm 160 micron	PP-Folie PP foil
SZ.A4.SS.DA.PP012	für Inhalt DIN A4 for A4	120 µm 120 micron	PP-Folie PP foil
NEU SZ.2XA4.PP014 ¹	für 2x Inhalt DIN A4 for 2x A4	140 µm 140 micron	PP-Folie PP foil
SZ.A3.SS.DA.ES.PP012	für Inhalt DIN A3 for A3	120 µm 120 micron	PP-Folie PP foil
SZ.A2.SS.WPVC018	für Inhalt DIN A2 for A2	180 µm 180 micron	Weich-PVC soft-PVC



Schutzhüllen nach Kundenwunsch

Protective covers - customised

- Mindestmenge: 250 Stück
minimum quantity: 250 pieces
- Sonderformate in fast jeder gewünschten Abmessung
custom-made in nearly all desired sizes
- Schmalseite oder Breitseite offen
short edge open or long edge open
- verschiedene Folienarten, Folienstärken und Folienfarben, z.B. glasklar, matt, transluzent oder farbig
available in different foil types, thicknesses and colours, e.g. transparent, frosted, translucent or coloured
- Abschweißungen / Aufschweißungen für mehrere Taschen
multiple pockets / welded on pockets
- mit Daumenausparung oder Einreißschutz
with thumb slot or tear protection
- auf Wunsch mit Klappe (auch mit Klettband oder Laschenverschluss)
with flap on request (also available with hook and loop fasteners or flap fastener)
- Aufdrucke im Siebdruck, Offsetdruck oder mit (Blind-)Prägung
overprint with silk screen printing, offset printing or with (blind) embossing

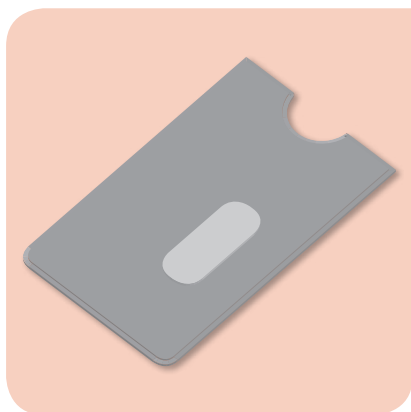

Scheckkartenhüllen

Credit card holders

Schmalseite offen

short edge open

Artikel-Nr. Item no.	Format Size	Ausführung Description	Folienstärke Foil thickness	Material
SK.058089.DA.LL.OO.MATT	58 x 86 / 89 mm	mit Langloch und Daumenausparung, matt-transparent with thumb slot, long hole, frosted-transparent	400 µm 400 micron	Hart-PVC rigid-PVC
SK.058089.DA.OO	58 x 86 / 89 mm	mit Daumenausparung, transparent klar with thumb slot, transparent	400 µm 400 micron	Hart-PVC rigid-PVC
SK.061091.SS.WPVC018	61 x 91 mm	transparent transparent	180 µm 180 micron	Weich-PVC soft-PVC







Hüllen für Schutz & Präsentation

Covers for protection & presentation



Scheckkartenhüllen nach Kundenwunsch

Credit card holders - customised

-  Mindestmenge: 2.000 Stück
minimum quantity: 2,000 pieces
-  egal ob Schmalseite oder Breitseite offen
short edge open or long edge open
-  verschiedene Folienarten, Folienstärken und Folienfarben, z.B. glasklar, matt, transluzent oder farbig
available in different foil types, thicknesses and colours, e.g. transparent, frosted, translucent or coloured
-  mit oder ohne Daumenausparung und / oder Langloch
with or without thumb slot and / or long hole
-  Aufdrucke im Tampondruck, Siebdruck oder Offsetdruck
overprinted by pad printing, silk screen or offset

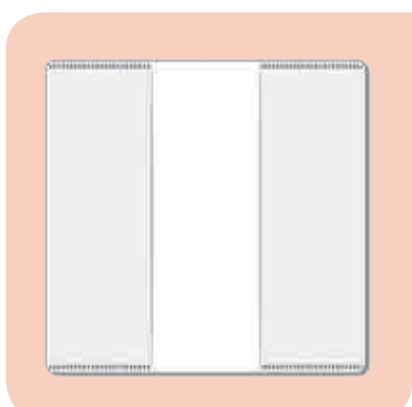

Umschlaghüllen / Tickettaschen

Covers for books and documents

mit zwei Innentaschen zur Faltnitte hin offen, transparent

with two in edge pockets, transparent







NEU

Artikel-Nr. <i>tem no.</i>	Format <i>Size</i>	Folienstärke <i>Foil thickness</i>	Material <i>Material</i>
UH.115160.FN.WPVC020	115 x 160 mm offen, 115 x 80 mm geschlossen (für DIN A7) <i>115 x 160 mm open, 115 x 80 mm closed, for A7</i>	200 µm <i>200 micron</i>	Weich-PVC <i>soft-PVC</i>
UH.135190.WPVC018	135 x 190 mm offen, 137 x 95 mm geschlossen (für Reisepässe ab 2017) <i>135 x 190 mm open, 137 x 95 mm closed (for passports off 2017)</i>	180 µm <i>180 micron</i>	Weich-PVC <i>soft-PVC</i>
UH.137200.WPVC018	137 x 200 mm offen, 137 x 100 mm geschlossen (für Reisepässe) <i>137 x 200 mm open, 137 x 100 mm closed (for passports)</i>	140 µm <i>140 micron</i>	Weich-PVC <i>soft-PVC</i>
UH.160220.WPVC018	160 x 220 mm offen, 160 x 110 mm geschlossen (für DIN A6) <i>160 x 220 mm open, 160 x 110 mm closed, for A6</i>	150 µm <i>150 micron</i>	Weich-PVC <i>soft-PVC</i>
UH.180260.WPVC018	180 x 260 mm offen, 180 x 130 mm geschlossen (für Mutterpässe) <i>180 x 260 mm open, 180 x 130 mm closed</i>	180 µm <i>180 micron</i>	Weich-PVC <i>soft-PVC</i>
UH.180390.WPVC018	180 x 390 mm offen, 3-teilig (für Mutterpässe) <i>180 x 390 mm open, three parts</i>	180 µm <i>180 micron</i>	Weich-PVC <i>soft-PVC</i>
UH.190405.2FN.PP020 ¹	190 x 405 mm offen, 3-teilig (für Mutterpässe) <i>190 x 405 mm open, three parts</i>	200 µm <i>200 micron</i>	PP-Folie <i>PP foil</i>
UH.219315.WPVC018	219 x 315 mm offen, 219 x 157,5 mm geschlossen (für DIN A5) <i>219 x 315 mm open, 219 x 157,5 mm closed, for A5</i>	140 µm <i>140 micron</i>	Weich-PVC <i>soft-PVC</i>
UH.230240.WPVC018	230 x 240 mm offen, 230 x 120 mm geschlossen (für Flugtickets) <i>230 x 240 mm open, 230 x 120 mm closed (for flight tickets)</i>	180 µm <i>180 micron</i>	Weich-PVC <i>soft-PVC</i>
UH.235240.FN.PP020 ²	235 x 240 mm offen, 235 x 120 mm geschlossen, je 80 mm zur Mitte hin offen (für Flugtickets) <i>235 x 240 mm open, 235 x 120 mm closed, 80 mm each, opened to the middle (for flight tickets)</i>	200 µm <i>200 micron</i>	PP-Folie <i>PP foil</i>
UH.305435.WPVC018	305 x 435 mm offen, 305 x 217,5 mm geschlossen (für DIN A4) <i>305 x 435 mm open, 305 x 217,5 mm closed, for A4</i>	140 µm <i>140 micron</i>	Weich-PVC <i>soft-PVC</i>



Umschlaghüllen nach Kundenwunsch

Covers for books and documents - customised

-  Mindestmenge: 250 Stück
minimum quantity: 250 pieces
-  Sonderformate in nahezu jeder gewünschten Abmessung (z.B. für Reisepässe, Mutterpässe oder Untersuchungshefte)
custom-made in nearly all required sizes (e.g. for passports or examination records)
-  Schmalseite oder Breitseite offen
short edge open or long edge open
-  verschiedene Folienarten, -stärken und -farben, z.B. glasklar, matt, transluzent oder farbig
available in different foil types, thicknesses and colours, e.g. transparent, frosted, translucent or coloured
-  Sonderausführungen, z.B. 3-teilig oder mit mehreren Innentaschen
special versions, e.g. 3 parts or with several inside pockets
-  mit aufgeschweißter Tasche (z.B. für Visitenkarte)
with welded-on pocket (e.g. for business card)
-  Aufdruck im Siebdruck, Offsetdruck oder mit (Blind-) Prägung
overprint by silk screen printing, offset printing or (blind) embossing



Hüllen für Schutz & Präsentation

Covers for protection & presentation

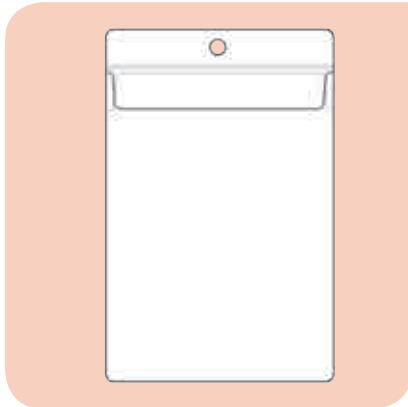

Hängetaschen

Display pockets

Weich-PVC, Hängerand mit Rundloch, transparent

soft-pvc, with hanging edge and round hole, transparent



Artikel-Nr. Item no.	Format Size	Ausführung Description	Folienstärke Foil thickness
HT.061124.SS.RL.WPVC018	für Inhalt 52 x 100 mm for 52 x 100 mm	Schmalseite offen ohne Klappe short edge open without flap	180 µm 180 micron
HT.A8.SS.RL.WPVC014	für Inhalt DIN A8 for A8	Schmalseite offen ohne Klappe short edge open without flap	140 µm 140 micron
HT.A7.SS.RL.WPVC014	für Inhalt DIN A7 for A7	Schmalseite offen, ohne Klappe short edge open, without flap	140 µm 140 micron
AH.A7.SS.RL	für Inhalt DIN A7 for A7	Schmalseite offen, Hinterfolie als Dach überstehend short edge open	180 µm 180 micron
HTA6.SS.RL.KL.WPVC016	für Inhalt DIN A6 for A6	Schmalseite offen, mit Klappe short edge open, with flap	160 µm 160 micron
HT.114180.RL5.WPVC018	für Inhalt DIN A6 for A6	Schmalseite offen, mit 5 mm Rundloch short edge open, 5 mm round hole	180 µm 180 micron
HT.A6.BS.RL.WPVC018	für Inhalt DIN A6 for A6	Breitseite offen long edge open	180 µm 180 micron
HT.DINLANG.SS.RL.WPVC018	für Inhalt DIN-lang for DL	Schmalseite offen, ohne Klappe short edge open, without flap	180 µm 180 micron
HT.A5.SS.RL.KL.WPVC016	für Inhalt DIN A5 for A5	Schmalseite offen, mit Klappe short edge open, with flap	160 µm 160 micron
HT.A5.SS.RL.WPVC018	für Inhalt DIN A5 for A5	Schmalseite offen, ohne Klappe short edge open, without flap	180 µm 180 micron
HTA4.SS.RL.KL.WPVC016	für Inhalt DIN A4 for A4	Schmalseite offen, mit Klappe short edge open, with flap	160 µm 160 micron
HTA4.SS.RL.WPVC018	für Inhalt DIN A4 for A4	Schmalseite offen, ohne Klappe short edge open, without flap	180 µm 180 micron

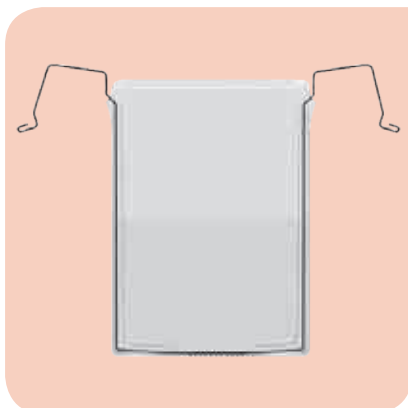

Drahtbügeltaschen

Wire framed pockets

Weich-PVC, transparent

soft-pvc, transparent



Artikel-Nr. Item no.	Format Size	Ausführung Description	Folienstärke Foil thickness
DBT.A5.BS.WPVC014.OE ¹	für Inhalt DIN A5 for A5	Breitseite offen long edge open	140 µm 140 micron
DBT.A5.BS.KL.WPVC014.OE	für Inhalt DIN A5 for A5	Breitseite offen mit Klappe long edge open with flap	140 µm 140 micron
DBT.A5.SS.WPVC014.OE	für Inhalt DIN A5 for A5	Schmalseite offen short edge open	140 µm 140 micron
DBT.A5.SS.KL.WPVC014.OE	für Inhalt DIN A5 for A5	Schmalseite offen mit Klappe short edge open with flap	140 µm 140 micron
DBT.A4.BS.WPVC014.OE	für Inhalt DIN A4 for A4	Breitseite offen long edge open	140 µm 140 micron
DBT.A4.BS.KL.WPVC014.OE	für Inhalt DIN A4 for A4	Breitseite offen mit Klappe long edge open with flap	140 µm 140 micron
DBT.A4.SS.WPVC014.OE ²	für Inhalt DIN A4 for A4	Schmalseite offen short edge open	140 µm 140 micron
DBT.A4.SS.KL.WPVC014.OE	für Inhalt DIN A4 for A4	Schmalseite offen mit Klappe short edge open with flap	140 µm 140 micron
DBT.A4_A5.SS.WPVC014.OE	für Inhalt DIN A4 for A4	Schmalseite offen mit zusätzlicher Tasche für DIN A5, Breitseite offen short edge open with additional pocket for A5, opening long edge	140 µm 140 micron
DBT.A4_A5.SS.WPVC014.OE	für Inhalt DIN A4 for A4	Schmalseite offen mit zusätzlicher Tasche für DIN A5, Breitseite offen short edge open with additional pocket for A5, opening long edge	140 µm 140 micron
DBT.A4.SS.KL.WPVC018.G	für Inhalt DIN A4 for A4	Schmalseite offen mit Klappe short edge open with flap	180 µm 180 micron
DBT.A4.SS.KL.WPVC018.G	für Inhalt DIN A4 for A4	Schmalseite offen mit Klappe short edge open with flap	180 µm 180 micron



Hüllen für Schutz & Präsentation

Covers for protection & presentation



Plakattaschen

Poster pockets

mit 2 Rundlöchern, matt-transparent

two round holes on the top, semi-transparent

Artikel-Nr. Item no.	Format Size	Folienstärke Foil thickness	Material Material
SZ.PT.A4.HOCH.2RL	für Inhalt DIN A4 for A4	400 µm 400 micron	Hart-PVC rigid-PVC

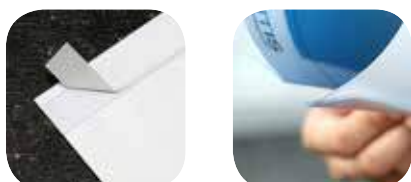
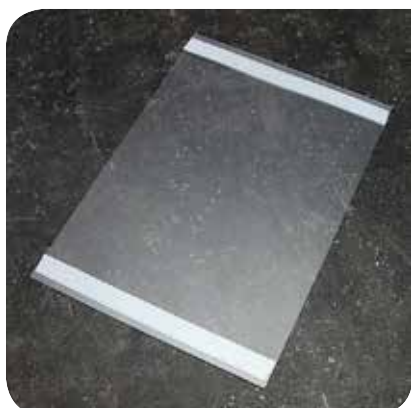

C-Hüllen

C-pockets

mit zwei Klebestreifen, matt-transparent







two stripes of adhesive tape, semi-transparent

Artikel-Nr. Item no.	Format Size	Folienstärke Foil thickness	Material Material
SZ.CH.A4.HOCH.2DK	für Inhalt DIN A4 for A4	400 µm 400 micron	Hart-PVC rigid-PVC



Hängetaschen nach Kundenwunsch

Display pockets - customised

-  Mindestmenge: 250 Stück
minimum quantity: 250 pieces
-  Sonderformate in fast jeder gewünschten Abmessung
custom-made in nearly all desired sizes
-  Schmalseite oder Breitseite offen
short edge open or long edge open
-  verschiedene Folienarten, Folienstärken und Folienfarben, z.B. glasklar, matt, transluzent oder farbig
available in different foil types, thicknesses and appearances, e.g. transparent, frosted, translucent or coloured
-  Abschweißungen / Aufschweißungen für mehrere Taschen
multiple pockets / welded-on pockets
-  Hängerland mit Rund-, Lang- oder Euroloch, auf Wunsch mit Metallöse verstärkt
hanging edge with round hole, slot or euro hole, strengthened with eyelets on request
-  Aufdrucke im Siebdruck, Offsetdruck oder mit (Blind-)Prägung
overprinted by silk screen, offset or with (blind) embossing



Hüllen für Schutz & Präsentation

Covers for protection & presentation



Dokumententaschen

Document folders





PP-Folie, Breitseite offen, transparent

PP foil, long edge open, transparent

Artikel-Nr. Item no.	Format Size	Ausführung Description	Folienstärke Foil thickness
SZ.105065.KL.KT.PP020 ¹	105 x 65 mm	mit trapezförmiger Klappe mit weißem Klettverschluss with trapezoidal flap and white velcro	200 µm 200 micron
SZ.A4.BS.KL.AF.PP018.DG ²	für Inhalt DIN A4 310 x 220/235 mm for DIN A4 310 x 220/235 mm	mit trapezförmiger Klappe mit Druckknopf, mit Abheftrand (15 mm breit, 11-fach gelocht, weiß verstärkt), diagonal gestreift with trapezoidal flap and snap fastener, with filing strip (15 mm wide with 11-on-1 hole, strengthened white), diagonal striped	180 µm 180 micron
SZ.A4.BS.KL.PP018	für Inhalt DIN A4 335 x 235 mm for DIN A4 335 x 235 mm	mit trapezförmiger Klappe mit Druckknopf with trapezoidal flap and snap fastener	180 µm 180 micron
SZ.A4.BS.KL.PP018.DG	für Inhalt DIN A4 335 x 235 mm for DIN A4 335 x 235 mm	mit trapezförmiger Klappe mit Druckknopf, diagonal gestreift long edge open, with trapezoidal flap and snap fastener, diagonal striped	180 µm 180 micron

Dokumententaschen nach Kundenwunsch

Document folders - customised

-  Mindestmenge: 1.000 Stück
minimum quantity: 1.000 pieces
-  Verschiedene Folienarten, Folienstärken
available in different foil types and thicknesses
-  Verschiedene Größen, Füllhöhen, Verschlüsse (z.B. Klettverschluss)
available in different measurements, filling height and flap fasteners
-  Mit aufgebracht Zusatztaschen und deren Größe sowie Material (z.B. mit Visitenkartentasche)
additional pockets in various sizes
-  Aufdrucke im Offsetdruck
additional offset prints



Kunststoffschleife für Gepäckanhänger

Luggage tags

transparent, ca. 2,5 mm dick
transparent, approx. 2.5 mm thick

Artikel-Nr. Item no.	Format Size
AH.KS.152.00	152 mm lang 152 mm long





Hüllen für Schutz & Präsentation

Covers for protection & presentation

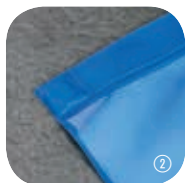

Magnettaschen

Magnetic pockets

Oberfolie Weich-PVC 200 µm, transparent, Unterfolie Weich-PVC 300 µm
Upper foil soft PVC 200 micron, transparent, bottom foil soft PVC 300 micron

Artikel-Nr. Item no.	Format Size	Ausführung Description	Farbe Colour
MT.A5.SS.B.04	160 x 215 / 225 mm	für DIN A5, Schmalseite offen for A5, short edge open	blau blue
NEU MT.A6.BS.B.03	164 x 110 / 115 mm	für DIN A6, Breitseite offen for A6, long edge open	rot red
MT.A6.BS.B.04	164 x 110 / 115 mm	für DIN A6, Breitseite offen for A6, long edge open	blau blue
NEU MT.A6.BS.B.07	164 x 110 / 115 mm	für DIN A6, Breitseite offen for A6, long edge open	grün green
NEU MT.A5.BS.B.03	225 x 152 / 160 mm	für DIN A5, Breitseite offen for A5, long edge open	rot red
MT.A5.BS.B.04 ¹	225 x 152 / 160 mm	für DIN A5, Breitseite offen for A5, long edge open	blau blue
NEU MT.A5.BS.B.07	225 x 152 / 160 mm	für DIN A5, Breitseite offen for A5, long edge open	grün green
NEU MT.A4.SS.B.03	234 x 304 / 312 mm	für DIN A4, Schmalseite offen for A4, short edge open	rot red
MT.A4.SS.B.04	234 x 304 / 312 mm	für DIN A4, Schmalseite offen for A4, short edge open	blau blue
MT.A4.SS.B.07	234 x 304 / 312 mm	für DIN A4, Schmalseite offen for A4, short edge open	grün green
NEU MT.A4.BS.B.03	315 x 217 / 234 mm	für DIN A4, Breitseite offen for A4, long edge open	rot red
MT.A4.BS.B.04	315 x 217 / 234 mm	für DIN A4, Breitseite offen for A4, long edge open	blau blue
NEU MT.A4.BS.B.07	315 x 217 / 234 mm	für DIN A4, Breitseite offen for A4, long edge open	grün green

mit 2 starken Neodym-Magneten, Oberfolie Weich-PVC 250 µm, transparent, Unterfolie Weich-PVC 300 µm

2 welded in neodymium magnets inside the hanging edge, upper foil soft PVC 250 micron, transparent, bottom foil soft-PVC 300 micron

Artikel-Nr. Item no.	Format Size	Ausführung Description	Farbe Colour
NEU MT.A6.BS.2MS.04	160 x 120 / 150 mm	für DIN A6, Breitseite offen for A6, long edge open	blau blue
NEU MT.A5.SS.2MS.04	160 x 120 / 150 mm	für DIN A5, Schmalseite offen for A5, short edge open	blau blue
MT.A5.BS.2MS.04 ²	230 x 152 / 190 mm	für DIN A5, Breitseite offen for A5, long edge open	blau blue
NEU MT.A4.SS.2MS.04	220 x 320 / 350 mm	für DIN A4, Schmalseite offen for A4, short edge open	blau blue
NEU MT.A4.SS.KL.2MS.04	220 x 320 / 350 mm	für DIN A4, Schmalseite offen, mit Klappe for A4, short edge open, with flap	blau blue
NEU MT.A4.BS.2MS.04	315 x 220 / 250 mm	für DIN A4, Breitseite offen for A4, long edge open	blau blue



Ausweishüllen mit farbigem Hängerand

ID pockets with coloured hanging edge

Hängerand mit 2 Rundlöchern und 1 Euroloch, Weich-PVC 400 µm
soft-PVC, hanging edge with 2 round holes and 1 euro hole, soft-PVC 400 micron

Artikel-Nr. Item no.	Farbe Colour
AH.SCHECK.BS.WPVC040.01	weiß white
AH.SCHECK.BS.WPVC040.02	schwarz black
AH.SCHECK.BS.WPVC040.04	blau blue
AH.SCHECK.BS.WPVC040.07	grün green



Hüllen für Schutz & Präsentation

Covers for protection & presentation



Ausweishüllen

ID pockets







Hängerand mit Rund-, Lang- oder Euroloch

hanging edge with round hole, euro hole or slot, transparent

Artikel-Nr. Item no.	Format Size	Ausführung Description	Folienstärke Foil thickness	Material
AH.060087.SS.EL	67 x 95 / 110 mm 67 x 95 / 110 mm	für Scheckkartenformat, Schmalseite offen, mit Euroloch for credit card size, short edge open, with euro hole	180 µm 180 micron	Weich-PVC soft-PVC
AH.087060.BS.EL ¹	95 x 65 / 77 mm 95 x 65 / 77 mm	für Scheckkartenformat, Breitseite offen, mit Euroloch for credit card size, long edge open, with euro hole	180 µm 180 micron	Weich-PVC soft-PVC
AH.A7.BS.LL ²	110 x 78 / 90 mm 110 x 78 / 90 mm	für Inhalt DIN A7, Breitseite offen, mit Langloch for A7, long edge open, with slot	180 µm 180 micron	Weich-PVC soft-PVC
AH.A7.BS.RL ³	110 x 78 / 90 mm 110 x 78 / 90 mm	für Inhalt DIN A7, Breitseite offen, mit Rundloch for A7, long edge open, with round hole	180 µm 180 micron	Weich-PVC soft-PVC
AH.A7.SS.RL	80 x 110 / 130 mm 80 x 110 / 130 mm	für Inhalt DIN A7, Schmalseite offen, Hinterfolie als Dach überstehend, mit Rundloch for A7, short edge open, with round hole, rear foil projecting	180 µm 180 micron	Weich-PVC soft-PVC
AH.A7.BS.EL.WPVC025 ⁴	113 x 77 / 94 mm 113 x 77 / 94 mm	für Inhalt DIN A7, Breitseite offen, Hängerand mit Euroloch for A7, long edge open, with euro hole	250 µm 250 micron	Weich-PVC soft-PVC
HT.114180.RL5.WPVC018 ⁵	114 x 157 / 180 mm 114 x 157 / 180 mm	für Inhalt DIN A6, Hängerand mit Rundloch for A6, hanging edge with round hole	180 µm 180 micron	Weich-PVC soft-PVC
AH.O.HP.00 ⁶	92 x 58 / 68 mm 92 x 58 / 68 mm	offene Ausweishülle für Scheckkartenformat, Schmalseite offen, mit zwei Rundlöchern und ein Euroloch ID pocket for credit card size, one short edge open, with two round holes and one euro hole		Hartplastik rigid plastic material
AH.SCHECK.HP.00 ⁷	92 x 58 / 68 mm 92 x 58 / 68 mm	für Scheckkartenformat, Schmalseite offen, Daumenlangloch in der Oberfolie, mit zwei Rundlöchern und einem Langloch ID pocket for credit card size, one short edge open, upper foil with thumb slot, with two round holes and one long hole		Hartplastik rigid plastic material
AH.SCHECK.BS.EL.WPVC025 ⁸	95 x 62 / 79 mm 95 x 62 / 79 mm	für Scheckkartenformat, Breitseite offen, Hängerand transparent mit Euroloch for credit card size, long edge open, hanging edge in transparent with euro hole	250 µm 250 micron	Weich-PVC soft-PVC

Ausweishüllen nach Kundenwunsch

ID pockets - customised

-  Mindestmenge: 250 Stück
minimum quantity: 250 pieces
-  Sonderformate in fast jeder gewünschten Abmessung
custom-made in nearly all desired sizes
-  Schmalseite oder Breitseite offen
short edge open or long edge open
-  verschiedene Folienarten, Folienstärken und Folienfarben, z.B. glasklar, matt, transluzent oder farbig
available in different foil types, thicknesses and appearances, e.g. transparent, frosted, translucent or coloured
-  Abschweißungen / Aufschweißungen für mehrere Taschen
welded or welded-on pockets
-  Hängerand mit Rund-, Lang- oder Euroloch, auf Wunsch mit Metallöse verstärkt
hanging edge with round hole, slot or euro hole, strengthened with eyelets on request
-  Aufdrucke im Siebdruck, Offsetdruck oder mit (Blind)-Prägung
overprinted by silk screen, offset, or with (blind) embossing



Hüllen für Schutz & Präsentation

Covers for protection & presentation



Kartenjojo aus Kunststoff

Badge reel made of plastic

mit Ansteckclip, Kunststoffschleife und Druckknopf, Ausziehlänge 864 mm
with belt clip, plastic loop and press stud, extendible length 864 mm

Artikel-Nr. | Item no. Farbe | Colour

AH.KJ.32.02 ■ schwarz | black

AH.KJ.32.04 ■ blau | blue



Hosenträgerclips

ID lever clips

für Ausweishüllen und Namensschilder
for card holders and name badges

Artikel-Nr. | Item no. Ausführung | Description

AH.HC.PK für Ausweishüllen mit Langloch oder Euroloch | suitable for ID card holders with slot or euro hole



Lanyard / Schlüsselband

Lanyards

mit drehbarem Metallhaken, 10 mm breit, offene Länge 900 mm
with rotatable metal hook, 10 mm wide, open length 900 mm

Artikel-Nr. | Item no. Farbe | Colour

AH.LY.10.DM.01 □ weiß | white

AH.LY.10.DM.02 ■ schwarz | black

AH.LY.10.DM.03 ■ rot | red

AH.LY.10.DM.04 ■ blau | blue

AH.LY.10.DM.07 ■ grün | green





Hüllen für Schutz & Präsentation

Covers for protection & presentation



Kombiklammern

Combi clips

für Ausweishüllen und Namensschilder

for card holders and name badges

Artikel-Nr. | Item no. Format | Size Ausführung | Description

NS.KK.029011.SK 29 x 11 mm Nadel-Clip-Kombination, selbstklebend | Metal pin and clip, self-adhesive

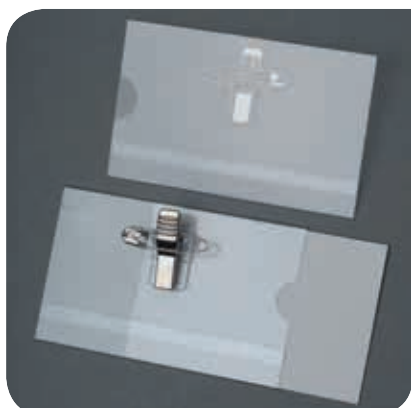

Namensschilder mit Kombiklammer

Name badge holders

mit Nadel & Clip (Kombiklammer), Hart-PVC 350 µm, transparent

with pin and clip, rigid-PVC 350 micron, transparent

Artikel-Nr. | Item no. Format | Size

NS.075040.KK 75 x 40 mm

NS.090058.KK 90 x 58 mm

Beschriftungsbogen | Sheets for labeling

NS.BSB.090055.9 90 x 55 mm

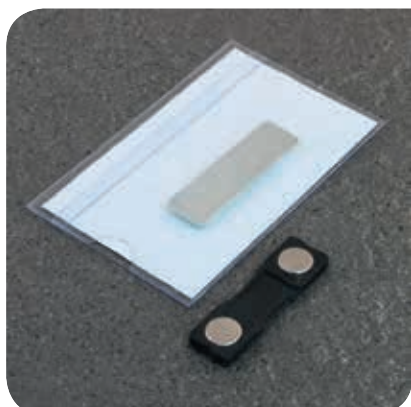

Namensschilder mit Magnet

Magnetic name badge holders

Magnetclip mit 2 Scheibenmagneten, Hart-PVC 350 µm, transparent

magnetic catch with 2 magnets, rigid-PVC 350 micron, transparent

Artikel-Nr. | Item no. Format | Size

NS.090058.MS 90 x 58 mm



Hüllen für Schutz & Präsentation

Covers for protection & presentation



Magnetclip für Namensschilder

Magnetic catch for badge holders

selbstklebend, bestehend aus Magnet- und Trägerplatte

self-adhesive, consisting of magnet- and base plate

	Artikel-Nr. Item no.	Format Size	Ausführung Description
NEU	MS.N3.033012.6_5.SK	33 x 12,5 x 6,5 mm	2 Scheibenmagneten 2 magnets
	MS.NS.045013.6.SK.316	45 x 13 x 6 mm	2 Scheibenmagneten 2 magnets
NEU	MS.NS.3MS.045013.6.SK	45 x 13 x 6 mm	3 Scheibenmagneten 3 magnets

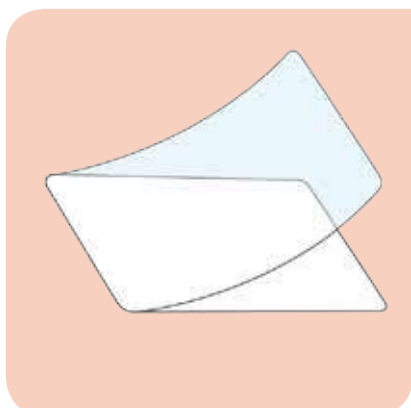

Kaltlaminierfolien

Self laminating cards

PP-Folie 200 µm transparent





PP foil 200 micron, transparent

Artikel-Nr. Item no.	Format Size
KL.054086	54 x 86 mm (Endformat Scheckkartengröße) 54 x 86 mm (end size like credit cards)
KL.066100	66 x 100 mm (für Einleger Scheckkartenformat, 54 x 86 mm) 66 x 100 mm (for inserts in credit card size, 54 x 86 mm)
KL.086117	86 x 117 mm (für DIN A7) 86 x 117 mm (for A7)
KL.117160	117 x 160 mm (für DIN A6) 117 x 160 mm (for A6)
KL.160222	160 x 222 mm (für DIN A5) 160 x 222 mm (for A5)
KL.225312	225 x 312 mm (für DIN A4) 225 x 312 mm (for A4)
KL.071115.LL	71 x 115 mm mit Langloch an der Schmalseite 71 x 115 mm with slot on the short edge



Kaltlaminierfolien nach Kundenwunsch

Self laminating cards - customised

-  Mindestmenge: 250 Stück
minimum quantity: 250 pieces
-  Sonderformate in fast jeder gewünschten Abmessung
custom-made in nearly all desired sizes
-  verschiedene Folienarten, Folienstärken und Folienfarben, z.B. glasklar, matt, transluzent oder farbig.
available in different foil types, thicknesses and appearances, e.g. transparent, frosted, translucent or coloured
-  große Stückzahlen aus PP-Folie (ohne Weichmacher)
large assortment of PP foil available (without softener)
-  Aufdruck im Siebdruck oder mit (Blind)-Prägung
overprinted by silk screen printing or with (blind) embossing



Hüllen für Schutz & Präsentation

Covers for protection & presentation

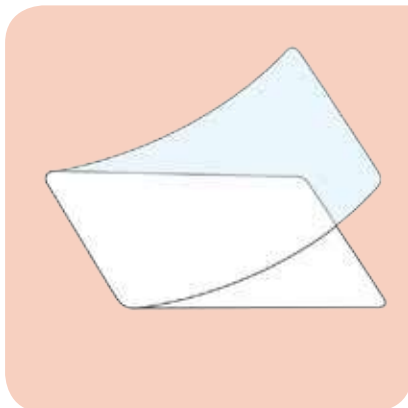

Heißlaminiertaschen

Hot laminating pouches

an einer Schmalseite verbunden, Ecken gerundet, PET-Folie, transparent

connected at short edge, rounded corners, PET foil, transparent

Artikel-Nr. Item no.	Format Size	Folienstärke Foil thickness	Ausführung Description
HL054086.080.G ¹	54 x 86 mm	2 x 80 µm 2 x 80 micron	glänzend glossy
HL054086.125.G	54 x 86 mm Endformat Scheckkartengröße 54 x 86 mm, end size for credit cards	2 x 125 µm 2 x 125 micron	glänzend glossy
HL065095.080.G	65 x 95 mm	2 x 80 µm 2 x 80 micron	glänzend glossy
HL065095.125.G	65 x 95 mm (für Einleger Scheckkartenformat, 54 x 86 mm) 65 x 95 mm for inserts in credit card size, 54 x 86 mm	2 x 125 µm 2 x 125 micron	glänzend glossy
HL075105.080.G	75 x 105 mm	2 x 80 µm 2 x 80 micron	glänzend glossy
HL075105.125.G	75 x 105 mm	2 x 125 µm 2 x 125 micron	glänzend glossy
HLA7.125.G	80 x 111 mm, für DIN A7 80 x 111 mm, for A7	2 x 125 µm 2 x 125 micron	glänzend glossy
HLA6.080.G	111 x 154 mm, für DIN A6 111 x 154 mm, for A6	2 x 80 µm 2 x 80 micron	glänzend glossy
HLA6.125.G	111 x 154 mm, für DIN A6 111 x 154 mm, for A6	2 x 125 µm 2 x 125 micron	glänzend glossy
HLA5.080.G	154 x 216 mm, für DIN A5 154 x 216 mm, for A5	2 x 80 µm 2 x 80 micron	glänzend glossy
HLA5.125.G	154 x 216 mm, für DIN A5 154 x 216 mm, for A5	2 x 125 µm 2 x 125 micron	glänzend glossy
HLA4.060.G	216 x 303 mm, für DIN A4 216 x 303 mm, for A4	2 x 60 µm 2 x 60 micron	glänzend glossy
HLA4.075.G	216 x 303 mm, für DIN A4 216 x 303 mm, for A4	2 x 75 µm 2 x 75 micron	glänzend glossy
HLA4.080.G	216 x 303 mm, für DIN A4 216 x 303 mm, for A4	2 x 80 µm 2 x 80 micron	glänzend glossy
HLA4.080.M	216 x 303 mm, für DIN A4 216 x 303 mm, for A4	2 x 80 µm 2 x 80 micron	matt matt
HLA4.080.SK.G	216 x 303 mm, für DIN A4 216 x 303 mm, for A4	2 x 80 µm 2 x 80 micron	glänzend, Rückseite selbstklebend glossy, self-adhesive back side
HLA4.100.G ²	216 x 303 mm, für DIN A4 216 x 303 mm, for A4	2 x 100 µm 2 x 100 micron	glänzend glossy
HLA4.125.G	216 x 303 mm, für DIN A4 216 x 303 mm, for A4	2 x 125 µm 2 x 125 micron	glänzend glossy
HLA4.125.M	216 x 303 mm, für DIN A4 216 x 303 mm, for A4	2 x 125 µm 2 x 125 micron	matt matt
HLA4.175.G	216 x 303 mm, für DIN A4 216 x 303 mm, for A4	2 x 175 µm 2 x 175 micron	glänzend glossy
HLA4.250.G	216 x 303 mm, für DIN A4 216 x 303 mm, for A4	2 x 250 µm 2 x 250 micron	glänzend glossy
HLA3.080.G	303 x 426 mm, für DIN A3 303 x 426 mm, for A3	2 x 80 µm 2 x 80 micron	glänzend glossy
HLA3.100.G	303 x 426 mm, für DIN A3 303 x 426 mm, for A3	2 x 100 µm 2 x 100 micron	glänzend glossy
HLA3.125.G	303 x 426 mm, für DIN A3 303 x 426 mm, for A3	2 x 125 µm 2 x 125 micron	glänzend glossy
HLA3.175.G	303 x 426 mm, für DIN A3 303 x 426 mm, for A3	2 x 175 µm 2 x 175 micron	glänzend glossy



Beutel für Versand & Verpackung
Bags for shipping & packaging





Beutel für Versand & Verpackung

Bags for shipping & packaging

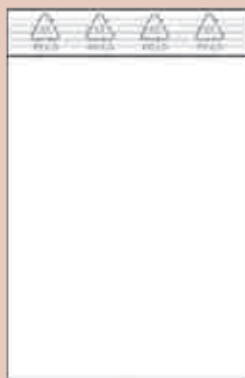

①



①



②

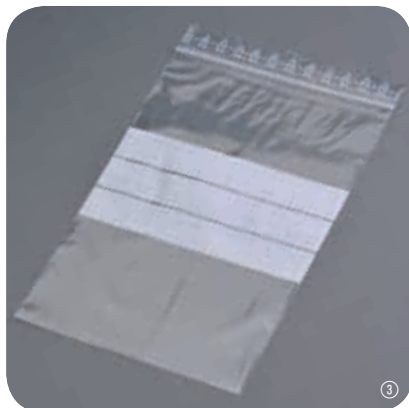

③

Druckverschlussbeutel, PE-Folie 50 µm

Zip lock bags, PE foil, 50 micron

Schmalseite offen, transparent

short edge open, transparent

Format Size	Artikel-Nr. Standard ¹ Item no. Standard ¹	Artikel-Nr. mit Euroloch ² Item no. with euro hole ²	Artikel-Nr. mit Beschriftungsstreifen ³ Item no. with labeling strip ³
35 x 55 mm	DV.035055.PE50		
40 x 60 mm	DV.040060.PE50	DV.040060.EL.PE50	DV.040060.BSS.PE50
40 x 170 mm	DV.040170.PE50		
40 x 230 mm	DV.040230.PE50		
45 x 220 mm	DV.045220.PE50		
50 x 70 mm	DV.050070.PE50		
50 x 75 mm	DV.050075.PE50		DV.050075.BSS.PE50
50 x 80 mm	DV.050080.PE50		
50 x 90 mm	DV.050090.PE50		
50 x 100 mm	DV.050100.PE50		
50 x 130 mm	DV.050130.PE50		
50 x 170 mm	DV.050170.PE50		
50 x 250 mm	DV.050250.PE50		
60 x 80 mm	DV.060080.PE50	DV.060080.EL.PE50	DV.060080.BSS.PE50
60 x 130 mm	DV.060130.PE50		
60 x 160 mm	DV.060160.PE50		
60 x 230 mm	DV.060230.PE50		
60 x 260 mm	DV.060260.PE50		
70 x 100 mm	DV.070100.PE50	DV.070100.EL.PE50	
75 x 90 mm	DV.075090.PE50		DV.075090.BSS.PE50
80 x 80 mm	DV.080080.PE50		
80 x 120 mm	DV.080120.PE50	DV.080120.EL.PE50	DV.080120.BSS.PE50
80 x 250 mm	DV.080250.PE50		
85 x 180 mm	DV.085180.PE50		
90 x 90 mm	DV.090090.PE50		
90 x 110 mm	DV.090110.PE50	DV.090110.EL.PE50	DV.090110.BSS.PE50
100 x 100 mm	DV.100100.PE50		
100 x 125 mm	DV.100125.PE50		DV.100125.BSS.PE50
100 x 150 mm	DV.100150.PE50	DV.100150.EL.PE50	DV.100150.BSS.PE50
100 x 220 mm	DV.100220.PE50		
115 x 155 mm	DV.115155.PE50	DV.115155.EL.PE50	DV.115155.BSS.PE50
120 x 120 mm	DV.120120.PE50		
120 x 170 mm	DV.120170.PE50	DV.120170.EL.PE50	DV.120170.BSS.PE50
120 x 180 mm	DV.120180.PE50		
120 x 250 mm	DV.120250.PE50		
150 x 180 mm	DV.150180.PE50		DV.150180.BSS.PE50
150 x 220 mm	DV.150220.PE50		
150 x 250 mm	DV.150250.PE50		
160 x 220 mm	DV.160220.PE50	DV.160220.EL.PE50	DV.160220.BSS.PE50
180 x 250 mm	DV.180250.PE50	DV.180250.EL.PE50	DV.180250.BSS.PE50
200 x 250 mm	DV.200250.PE50		
200 x 300 mm	DV.200300.PE50	DV.200300.EL.PE50	DV.200300.BSS.PE50
220 x 280 mm	DV.220280.PE50		
220 x 310 mm	DV.220310.PE50	DV.220310.EL.PE50	DV.220310.BSS.PE50



Beutel für Versand & Verpackung

Bags for shipping & packaging

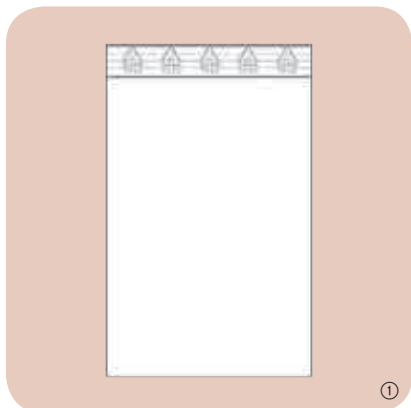

Format Size	Artikel-Nr. Standard ¹ Item no. Standard ¹	Artikel-Nr. mit Euroloch ² Item no. with euro hole ²	Artikel-Nr. mit Beschriftungsstreifen ³ Item no. with labeling strip ³
250 x 350 mm	DV.250350.PE50		DV.250350.BSS.PE50
280 x 400 mm	DV.280400.PE50		
300 x 400 mm	DV.300400.PE50		DV.300400.BSS.PE50
300 x 500 mm	DV.300500.PE50		
350 x 450 mm	DV.350450.PE50		
400 x 500 mm	DV.400500.PE50		
400 x 600 mm	DV.400600.PE50		
500 x 600 mm	DV.500600.PE50		

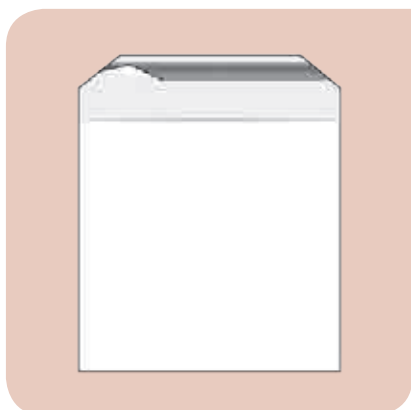

PE-Klappenbeutel für den Versand

PE bags with flap for mailing

Schmalseite offen, Klappe mit Klebeverschluss, PE-Folie transparent

short edge open, flap with adhesive strip, PE foil transparent



Artikel-Nr. Item no.	Format Size	Klappe Flap	Folienstärke Foil thickness
NEU KB.070100.PE50	70 x 100 mm 70 x 100 mm	30 mm	50 µm 50 micron
NEU KB.080120.PE50	80 x 120 mm 80 x 120 mm	30 mm	50 µm 50 micron
KB.105150.PE50	105 x 150 mm 105 x 150 mm	30 mm	50 µm 50 micron
NEU KB.110170.PE50	110 x 170 mm 110 x 170 mm	30 mm	50 µm 50 micron
NEU KB.110220.PE35	DIN-lang, 110 x 220 mm DL, 110 x 220 mm	30 mm	35 µm 35 micron
KB.110220.PE70	DIN-lang, 110 x 220 mm DL, 110 x 220 mm	30 mm	70 µm 70 micron
NEU KB.119162.PE35	119 x 162 mm 119 x 162 mm	40 mm	35 µm 35 micron
KB.119162.PE50	DIN C6, 119 x 162 mm C6, 119 x 162 mm	40 mm	50 µm 50 micron
KB.120230.PE60 ²	DIN-lang, 120 x 230 mm DL, 120 x 230 mm	50 mm	60 µm 60 micron
NEU KB.130130.PE50	130 x 130 mm 130 x 130 mm	30 mm	50 µm 50 micron
KB.130180.PE50	130 x 180 mm 130 x 180 mm	50 mm	50 µm 50 micron
KB.165220.PE50	DIN C5, 165 x 220 mm C5, 165 x 220 mm	40 mm	50 µm 50 micron
NEU KB.165220.PE35	165 x 220 mm 165 x 220 mm	40 mm	35 µm 35 micron
KB.165220.PE70	165 x 220 mm 165 x 220 mm	40 mm	70 µm 70 micron
NEU KB.180250.PE35	DIN B5, 180 x 250 mm B5, 180 x 250 mm	50 mm	35 µm 35 micron
KB.180250.PE70	DIN B5, 180 x 250 mm B5, 180 x 250 mm	50 mm	70 µm 70 micron
KB.220215.PE50	DIN 1/6, 220 x 215 mm 1/6, 220 x 215 mm	50 mm	50 µm 50 micron
KB.225310.PE35	DIN C4, 225 x 310 mm C4, 225 x 310 mm	50 mm	35 µm 35 micron
KB.225310.PE50 ¹	DIN C4, 225 x 310 mm C4, 225 x 310 mm	50 mm	50 µm 50 micron
KB.225310.PE70	DIN C4, 225 x 310 mm C4, 225 x 310 mm	50 mm	70 µm 70 micron
NEU KB.225310.PERM.PE70 ³	225 x 310 mm, Klebeverschluss permanent 225 x 310 mm, self-adhesive strip permanent	50 mm	70 µm 70 micron
KB.240320.PE50	240 x 320 mm 240 x 320 mm	40 mm	50 µm 50 micron
KB.250350.PE70	DIN B4, 250 x 350 mm B4, 250 x 350 mm	50 mm	70 µm 70 micron
NEU KB.250350.PE50	DIN B4, 250 x 350 mm B4, 250 x 350 mm	50 mm	50 µm 50 micron
NEU KB.250350.PERM.PE70	DIN B4, 250 x 350 mm, Klebeverschluss permanent B4, 250 x 350 mm, self-adhesive strip permanent	50 mm	70 µm 70 micron
KB.300400.PE50	300 x 400 mm 300 x 400 mm	50 mm	50 µm 50 micron
KB.310440.PE70	für DIN A3, 310 x 440 mm for A3, 310 x 440 mm	50 mm	70 µm 70 micron



Beutel für Versand & Verpackung

Bags for shipping & packaging



Artikel-Nr. Item no.	Format Size	Klappe Flap	Folienstärke Foil thickness
KB.350450.PE50	350 x 450 mm 350 x 450 mm	50 mm	50 µm 50 micron
KB.400500.PE50	400 x 500 mm 400 x 500 mm	50 mm	50 µm 50 micron
KB.440620.PE70	für DIN A2, 440 x 620 mm for A2, 440 x 620 mm	50 mm	70 µm 70 micron

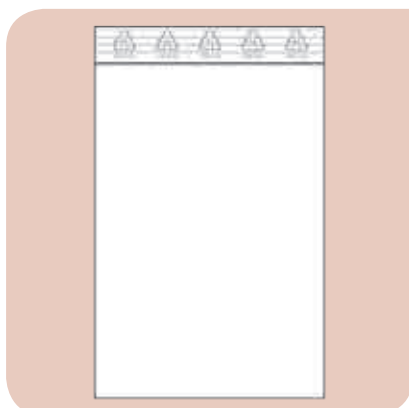

Druckverschlussbeutel, PE-Folie 90 µm

Zip lock bags, PE foil, 90 micron

Schmalseite offen, transparent

short edge open, transparent

Format Size	Artikel-Nr. Standard ¹ Item no. Standard ¹	Artikel-Nr. mit Euroloch ² Item no. with euro hole ²	Artikel-Nr. mit Beschriftungsstreifen ³ Item no. with labeling strip ³
70 x 100 mm	DV.070100.PE90	DV.070100.EL.PE90	DV.070100.BSS.PE90
80 x 120 mm	DV.080120.PE90	DV.080120.EL.PE90	DV.080120.BSS.PE90
100 x 150 mm	DV.100150.PE90	DV.100150.EL.PE90	DV.100150.BSS.PE90
110 x 220 mm	DV.110220.PE90	DV.110220.EL.PE90	DV.110220.BSS.PE90
120 x 170 mm	DV.120170.PE90	DV.120170.EL.PE90	DV.120170.BSS.PE90
160 x 220 mm	DV.160220.PE90	DV.160220.EL.PE90	DV.160220.BSS.PE90
180 x 250 mm	DV.180250.PE90	DV.180250.EL.PE90	DV.180250.BSS.PE90
200 x 300 mm	DV.200300.PE90	DV.200300.EL.PE90	DV.200300.BSS.PE90
220 x 310 mm	DV.220310.PE90	DV.220310.EL.PE90	DV.220310.BSS.PE90
250 x 350 mm	DV.250350.PE90	DV.250350.EL.PE90	DV.250350.BSS.PE90
300 x 400 mm	DV.300400.PE90	DV.300400.EL.PE90	DV.300400.BSS.PE90
300 x 600 mm	DV.400600.PE90		





Beutel für Versand & Verpackung

Bags for shipping & packaging

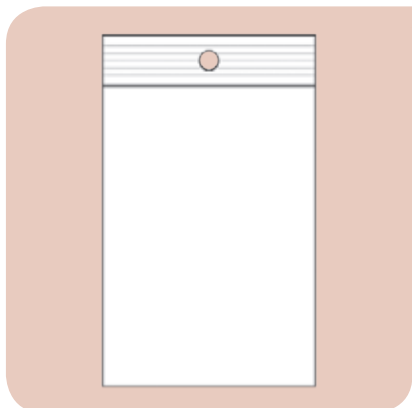

Druckverschlussbeutel, PP-Folie 50 µm

Zip lock bags with hole, PP foil, 50 micron

mit Rundloch, Schmalseite offen, transparent
round hole, short edge open, transparent

Format | Size **Artikel-Nr. | Item no.**

70 x 100 mm DV.070100.RL.PP50

80 x 120 mm DV.080120.RL.PP50

100 x 150 mm DV.100150.RL.PP50

120 x 170 mm DV.120170.RL.PP50

160 x 220 mm DV.160220.RL.PP50

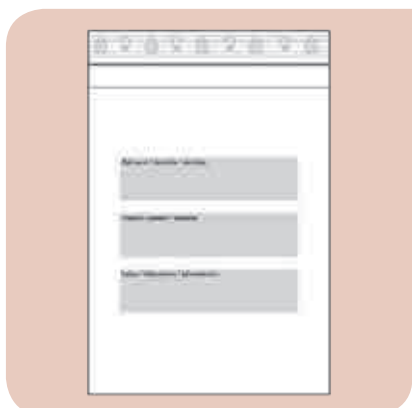

Dental-Druckverschlussbeutel, PE-Folie 50 µm

Dental zip lock bags, PE foil, 50 micron

Schmalseite offen, transparent, mit zusätzlicher Kängurutasche und 3 Beschriftungsstreifen
short edge open, transparent, with additional kangaroo pocket, with three labeling strips

Artikel-Nr. | Item no. **Format | Size**

DV.180250.T.BSS.PE50 180 x 250 mm



PP-Klappenbeutel mit Warntext, PP-Folie 40 µm

Bags with flap, with warning imprint, PP foil 40 micron

Klappe mit Klebeverschluss, Schmalseite offen, transparent, Warnhinweis:
„WARNUNG! Für Kinder unter 36 Monaten nicht geeignet. Erstickungsgefahr.“
flap with self-adhesive strip, short edge open, transparent, with warning imprint:
“WARNING! Not suitable for children under 36 months! Suffocation hazard.”

Artikel-Nr. | Item no. **Format | Size** **Klappe | Flap**

KB.210300.PP40.HINW 210 x 300 mm 50 mm

KB.300400.PP40.HINW 300 x 400 mm 50 mm

KB.460620.PP40.HINW 460 x 620 mm 50 mm



Beutel für Versand & Verpackung

Bags for shipping & packaging



PP-Klappenbeutel für den Versand

PP bags with flap for mailing

PP-Folie 50 µm, Klappe mit Klebeverschluss, PP-Folie transparent, Schmalseite offen

PP foil 50 micron, flap with adhesive strip, transparent, short edge open

Artikel-Nr. Item no.	Format Size	Klappe Flap
KB.165220.PP50	DIN C5, 165 x 220 mm C5, 165 x 220 mm	40 mm
KB.225310.PP50	DIN C4, 225 x 310 mm C4, 225 x 310 mm	50 mm
KB.250350.PP50	DIN B4, 250 x 350 mm B4, 250 x 350 mm	50 mm
KB.300400.PP50	300 x 400 mm 300 x 400 mm	50 mm

PP-Folie 100 µm, Klappe abgeschrägt mit Knicknaht und Klebeverschluss, transparent, Breitseite offen

PP foil 100 micron, sloped flap with self-adhesive strip, transparent, long edge open

Artikel-Nr. Item no.	Format Size	Klappe Flap
KB.162114.PP100	DIN C6, 162 x 114 mm C6, 162 x 114 mm	30 mm
KB.220110.PP100	DIN-lang, 220 x 110 DL, 220 x 110	30 mm
KB.229114.PP100	DIN C5 / C6, 229 x 114 mm C5 / C6, 229 x 114 mm	30 mm
KB.229162.PP100	DIN C5, 229 x 162 mm C5, 229 x 162 mm	30 mm
KB.324229.PP100	DIN C4, 324 x 229 mm C4, 324 x 229 mm	30 mm

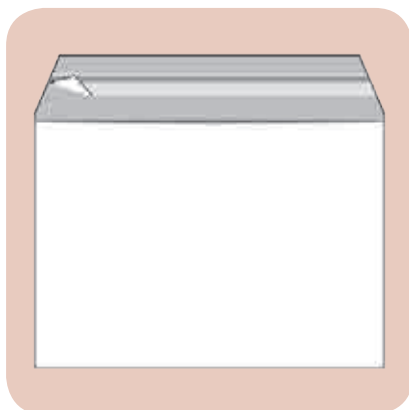

PP-Flachbeutel, PP-Folie 40 µm

PP flat bags, PP foil 40 micron

Schmalseite offen, transparent

short edge open, transparent

Artikel-Nr. Item no.	Format Size
FB.062310.PP40	62 x 310 mm
FB.080110.PP40	80 x 110 mm
FB.100150.PP40	100 x 150 mm
FB.110220.PP40	110 x 220 mm
FB.125250.PP40	125 x 250 mm
FB.160300.PP40	160 x 300 mm
FB.170235.PP40	170 x 325 mm
FB.200300.PP40	200 x 300 mm

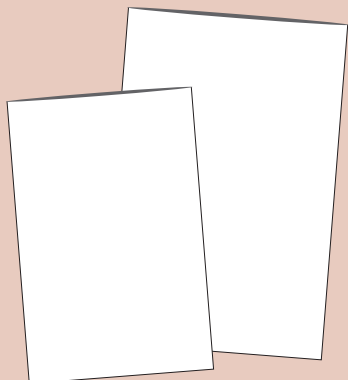



Beutel für Versand & Verpackung

Bags for shipping & packaging

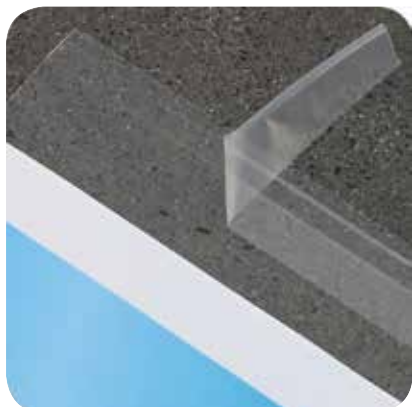
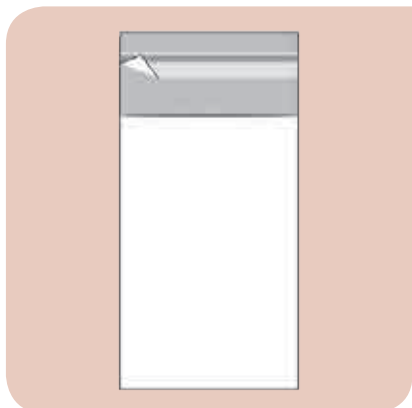

OPP-Klappenbeutel für Glückwunschkarten, OPP-Folie 30 µm

OPP bags with flap for greeting cards, OPP foil 30 micron

Schmalseite offen, Klappe mit Klebeverschluss, transparent

short edge open, flap with adhesive strip, transparent

Artikel-Nr. Item no.	Format Size	Klappe Flap
KB.040060.OPP30	40 x 60 mm 40 x 60 mm	20 mm
KB.050070.OPP30	50 x 70 mm 50 x 70 mm	30 mm
KB.050180.OPP30	50 x 180 mm 50 x 180 mm	30 mm
KB.060082.OPP30	DIN C8, 60 x 82 mm C8, 60 x 82 mm	30 mm
KB.060120.OPP30	60 x 120 mm 60 x 120 mm	30 mm
KB.060240.OPP30	60 x 240 mm 60 x 240 mm	30 mm
KB.065130.OPP30	65 x 130 mm 65 x 130 mm	30 mm
KB.070100.OPP30	70 x 100 mm 70 x 100 mm	30 mm
KB.075095.OPP30	75 x 95 mm 75 x 95 mm	30 mm
NEU KB.080080.OPP30	80 x 80 mm 80 x 80 mm	30 mm
KB.080120.OPP30	80 x 120 mm 80 x 120 mm	30 mm
KB.080160.OPP30	80 x 160 mm 80 x 160 mm	30 mm
KB.080180.OPP30	80 x 180 mm 80 x 180 mm	30 mm
KB.087116.OPP30	DIN C7, 87 x 116 mm C7, 87 x 116 mm	30 mm
KB.090130.OPP30	90 x 130 mm 90 x 130 mm	30 mm
KB.095105.OPP30	95 x 105 mm 95 x 105 mm	30 mm
KB.095130.OPP30	95 x 130 mm 95 x 130 mm	30 mm
NEU KB.100100.OPP30	100 x 100 mm 100 x 100 mm	30 mm
NEU KB.100125.OPP30	100 x 125 mm 100 x 125 mm	30 mm
KB.100200.OPP30	100 x 200 mm 100 x 200 mm	30 mm
KB.100250.OPP30	100 x 250 mm 100 x 250 mm	30 mm
KB.105150.OPP30	105 x 150 mm 105 x 150 mm	30 mm
KB.110110.OPP30	110 x 110 mm 110 x 110 mm	30 mm
KB.110170.OPP30	110 x 170 mm 110 x 170 mm	30 mm
KB.115220.OPP30	DIN-lang, 115 x 220 mm DL, 115 x 220 mm	30 mm
KB.119162.OPP30	DIN C6, 119 x 162 mm C6, 119 x 162 mm	30 mm
KB.120200.OPP30	120 x 200 mm 120 x 200 mm	30 mm
KB.125185.OPP30	125 x 185 mm 125 x 185 mm	30 mm
KB.130130.OPP30	130 x 130 mm 130 x 130 mm	30 mm
KB.130180.OPP30	DIN B6, 130 x 180 mm B6, 30 x 180 mm	30 mm
KB.140220.OPP30	140 x 220 mm 140 x 220 mm	30 mm
KB.145155.OPP30	145 x 155 mm 145 x 155 mm	30 mm
NEU KB.150150.OPP30	150 x 150 mm 150 x 150 mm	30 mm
KB.150180.OPP30	150 x 180 mm 150 x 180 mm	30 mm
KB.150300.OPP30	150 x 300 mm 150 x 300 mm	30 mm
KB.155200.OPP30	155 x 200 mm 155 x 200 mm	30 mm
NEU KB.155215.OPP30	155 x 215 mm 155 x 215 mm	30 mm
KB.160160.OPP30	160 x 160 mm 160 x 160 mm	30 mm
NEU KB.165165.OPP30	165 x 165 mm 165 x 165 mm	30 mm
KB.165220.OPP30	DIN C5, 165 x 220 mm C5, 165 x 220 mm	30 mm
NEU KB.165230.OPP30	165 x 230 mm 165 x 230 mm	30 mm
KB.170170.OPP30	170 x 170 mm 170 x 170 mm	30 mm
KB.180280.OPP30	180 x 280 mm 180 x 280 mm	30 mm
KB.180245.OPP30	DIN B5, 180 x 245 mm B5, 180 x 245 mm	30 mm
KB.180300.OPP30	180 x 300 mm 180 x 300 mm	30 mm



Beutel für Versand & Verpackung Bags for shipping & packaging

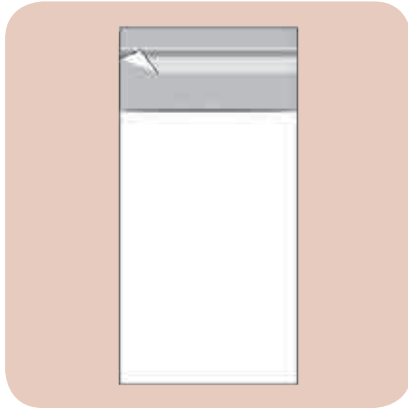









Artikel-Nr. Item no.	Format Size	Klappe Flap
KB.180350.OPP30	180 x 350 mm 180 x 350 mm	30 mm
NEU KB.200200.OPP30	200 x 200 mm 200 x 200 mm	30 mm
KB.200250.OPP30	200 x 250 mm 200 x 250 mm	30 mm
KB.200300.OPP30	200 x 300 mm 200 x 300 mm	30 mm
NEU KB.220215.OPP30	220 x 215 mm 220 x 215 mm	30 mm
KB.220280.OPP30	220 x 280 mm 220 x 280 mm	30 mm
KB.225310.OPP30	DIN C4, 225 x 310 mm C4, 225 x 310 mm	40 mm
KB.240320.OPP30	240 x 320 mm 240 x 320 mm	40 mm
NEU KB.250250.OPP30	250 x 250 mm 250 x 250 mm	40 mm
KB.250350.OPP30	250 x 350 mm 250 x 350 mm	40 mm
NEU KB.300300.OPP30	300 x 300 mm 300 x 300 mm	40 mm
KB.300400.OPP30	300 x 400 mm 300 x 400 mm	40 mm



Klappenbeutel nach Kundenwunsch

Bags with flap - customised

-  Mindestmenge: 5.000 Stück
minimum quantity: 5,000 pieces
-  Sonderformate in fast jeder gewünschten Abmessung
custom-made in almost all sizes as required
-  verschiedene Folienstärken für jeden Einsatzzweck
different foil thicknesses for every purpose
-  für Füllhöhe mit Seitenfalte oder Bodenfalte
for filling level with side or bottom gusset
-  Schmalseite oder Breitseite offen
short edge or long edge open
-  PE-Folie, PP-Folie, hochtransparente OPP-Folie oder COEX-Folie (schwarz/weiß) möglich
PE foil, PP foil, highly transparent OPP foil or COEX foil (black / white)
-  Klappe mit permanentem oder ablösbarem Klebestreifen
flap with adhesive or removable strip
-  ungelocht oder gelocht (Luftloch)
with or without hole (with added air hole)
-  auf Wunsch mit Hängerand inkl. Rund- oder Euroloch
with hanger edge incl. round or euro hole as required
-  Aufdruck im Flexodruck, Inkjetdruck oder Thermotransfer
overprint by flexo printing, inkjet printing or thermotransfer



Beutel für Versand & Verpackung

Bags for shipping & packaging

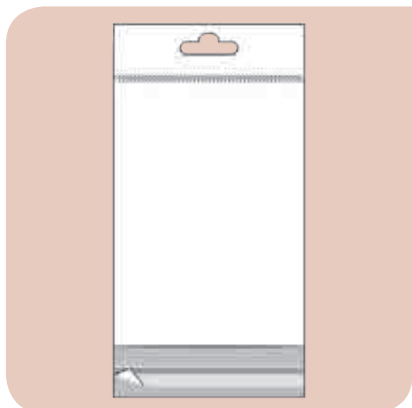

Headerbeutel, OPP-Folie 30 µm

Header bags, OPP foil 30 micron

Schmalseite offen, mit Klebeverschluss, 30 mm Hängerrand mit Euroloch, transparent verstärkt
short edge open, with self-adhesive strip, additional 30 mm hanging part with euro-hole, with transparent inner strengthening

Artikel-Nr. Item no.	Format Size	Klappe Flap
KB.080110.EL.OPP30	für DIN A7, 80 x 110 mm for A7, 80 x 110 mm	30 mm
KB.110155.EL.OPP30	für DIN A6, 110 x 155 mm for A6, 110 x 155 mm	30 mm
KB.155215.EL.OPP30	für DIN A5, 115 x 215 mm for A5, 115 x 215 mm	30 mm
KB.115220.EL.OPP30	DIN-lang, 115 x 220 mm DL, 115 x 220 mm	30 mm



transparent ohne Verstärkung

transparent without inner strengthening

Artikel-Nr. Item no.	Format Size	Klappe Flap
KB.215310.EL.OV.OPP30	für DIN A4, 215 x 310 mm for A4, 215 x 310 mm	40 mm

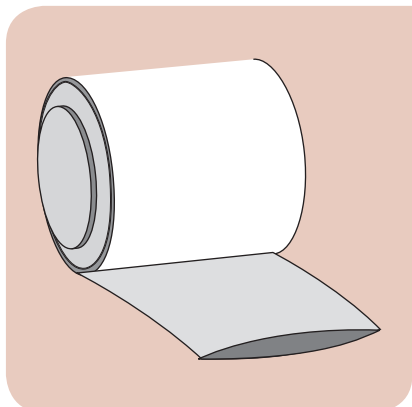

Schlauchfolie

Tubularfoil

auf Rolle, PE-Folie transparent

in rolls, PE foil transparent

Breite Width	Artikel-Nr. 50 µm (Rolle mit 500 m) Item no. 50 micron (rolls with 500 m)	Artikel-Nr. 100 µm (Rolle mit 250 m) Item no. 100 micron (rolls with 250 m)
50 mm	SF.50.PE50.500	SF.50.PE100.250
80 mm	SF.80.PE50.500	SF.80.PE100.250
100 mm	SF.100.PE50.500	SF.100.PE100.250
120 mm	SF.120.PE50.500	SF.120.PE100.250
150 mm	SF.150.PE50.500	SF.150.PE100.250
200 mm	SF.200.PE50.500	SF.200.PE100.250
250 mm	SF.250.PE50.500	SF.250.PE100.250
300 mm	SF.300.PE50.500	SF.300.PE100.250
350 mm	SF.350.PE50.500	SF.350.PE100.250
400 mm	SF.400.PE50.500	SF.400.PE100.250
500 mm		SF.500.PE100.250
600 mm		SF.600.PE100.250



Breite Width	Artikel-Nr. 50 µm (Rolle mit 250 m) Item no. 50 micron (rolls with 250 m)	Artikel-Nr. 100 µm (Rolle mit 125 m) Item no. 100 micron (rolls with 125 m)
500 mm	SF.500.PE50.250	
600 mm	SF.600.PE50.250	
700 mm	SF.700.PE50.250	SF.700.PE100.125

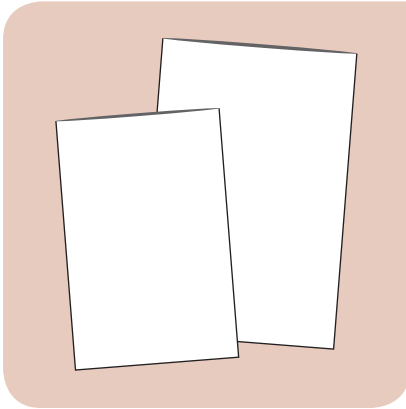

PE-Flachbeutel

PE flat bags

Schmalseite offen, PE-Folie transparent

short edge open, PE foil transparent

Format Size	Artikel-Nr. 25 µm Item no. 25 micron	Artikel-Nr. 50 µm Item no. 50 micron	Artikel-Nr. 100 µm Item no. 100 micron
40 x 60 mm		FB.040060.PE50	
50 x 80 mm		FB.050080.PE50	
50 x 100 mm		FB.050100.PE50	
60 x 90 mm		FB.060090.PE50	
70 x 80 mm			FB.070080.PE100
70 x 100 mm		FB.070100.PE50	
80 x 120 mm ¹		FB.080120.PE50	FB.080120.PE100
80 x 750 mm		FB.080750.PE50	
100 x 125 mm			FB.100125.PE100
100 x 150 mm		FB.100150.PE50	
100 x 200 mm	FB.100200.PE25	FB.100200.PE50	
100 x 1000 mm ²		FB.1001000.PE50	
120 x 180 mm		FB.120180.PE50	
120 x 220 mm	FB.120220.PE25		
150 x 200 mm		FB.150200.PE50	
150 x 210 mm		FB.150210.PE50	
150 x 250 mm		FB.150250.PE50	
150 x 300 mm		FB.150300.PE50	
160 x 240 mm	FB.160240.PE25		
160 x 250 mm		FB.160250.PE50	FB.160250.PE5100
170 x 320 mm		FB.170320.PE50	
180 x 220 mm			FB.180220.PE100
200 x 300 mm	FB.200300.PE25	FB.200300.PE50	FB.200300.PE100
200 x 320 mm		FB.200320.PE50	
220 x 360 mm		FB.220360.PE50	
250 x 350 mm	FB.250350.PE25	FB.250350.PE50	FB.250350.PE100
250 x 400 mm	FB.250400.PE25	FB.250400.PE50	FB.250400.PE100
300 x 400 mm	FB.300400.PE25	FB.300400.PE50	
300 x 450 mm			FB.300450.PE100
300 x 500 mm	FB.300500.PE25	FB.300500.PE50	FB.300500.PE100
350 x 550 mm		FB.350550.PE50	
400 x 500 mm		FB.400500.PE50	
400 x 600 mm	FB.400600.PE25	FB.400600.PE50	FB.400600.PE100
450 x 600 mm			FB.450600.PE100
450 x 650 mm		FB.450650.PE50	
500 x 600 mm		FB.500600.PE50	
500 x 700 mm		FB.500700.PE50	FB.500700.PE100
500 x 800 mm		FB.500800.PE50	
550 x 800 mm			FB.550800.PE100
600 x 800 mm		FB.600800.PE50	
600 x 900 mm			FB.600900.PE100
800 x 1200 mm			FB.8001200.PE120









Beutel für Versand & Verpackung

Bags for shipping & packaging



Flachbeutel nach Kundenwunsch

Flat bags - customised

-  Mindestmenge: 5.000 Stück
minimum quantity: 5,000 pieces
-  Sonderformate in fast jeder gewünschten Abmessung
custom-made in almost every desired size
-  verschiedene Folienstärken für jeden Einsatzzweck
different foil thicknesses for every purpose
-  für Füllhöhe mit Seitenfalte oder Bodenfalte
for filling level with side or bottom gusset
-  Schmalseite oder Breitseite offen
short edge or long edge open
-  PE-Folie, PP-Folie, hochtransparente OPP-Folie oder COEX-Folie (schwarz/weiß) möglich
PE foil, PP foil, highly transparent OPP foil or COEX foil (black / white)
-  ungelocht oder gelocht (Luftloch)
with or without hole (with added air hole)
-  auf Wunsch mit Hängerand inkl. Rund- oder Euroloch
with hanger edge incl. round or euro hole as required
-  Aufdruck im Flexodruck, Inkjetdruck oder Thermotransfer
overprint by flexo printing, inkjet printing or thermotransfer



Kordelzugbeutel, PE-Folie 50 µm

Drawstring bags, PE foil 50 micron

Schmalseite offen, transparent

short edge open, transparent

Artikel-Nr. | Item no. Format | Size

	KZ.100120.PE50	100 x 120 mm
	KZ.150210.PE50	150 x 210 mm
	KZ.170250.PE50	170 x 250 mm
	KZ.200270.PE50	200 x 270 mm
	KZ.250320.PE50	250 x 320 mm
	KZ.250370.PE50	250 x 370 mm
	KZ.300440.PE50	300 x 440 mm
	KZ.300470.PE50	300 x 470 mm
	KZ.400570.PE50	400 x 570 mm



Schieberschlussbeutel

Slide lock bags

PE-Folie transparent

PE foil transparent

Artikel-Nr. Item no.	Format Size	Folienstärke Foil thickness	Öffnung Opening
SV.120170.PE60	120 x 170 mm	60 µm 60 micron	Schmalseite offen short edge open
SV.160220.PE60	160 x 220 mm	60 µm 60 micron	Schmalseite offen short edge open
SV.200300.PE60	200 x 300 mm	60 µm 60 micron	Schmalseite offen short edge open
SV.225310.PE60	225 x 310 mm	60 µm 60 micron	Schmalseite offen short edge open
SV.320440.PE75	320 x 440 mm	75 µm 75 micron	Schmalseite offen short edge open
SV.480640.PE70	480 x 640 mm	70 µm 70 micron	Schmalseite offen short edge open
SV.170120.PE60	170 x 120 mm	60 µm 60 micron	Breitseite offen long edge open
SV.200150.PE60	200 x 150 mm	60 µm 60 micron	Breitseite offen long edge open
SV.250170.PE60	250 x 170 mm	60 µm 60 micron	Breitseite offen long edge open
SV.320230.PE75	320 x 230 mm	75 µm 75 micron	Breitseite offen long edge open

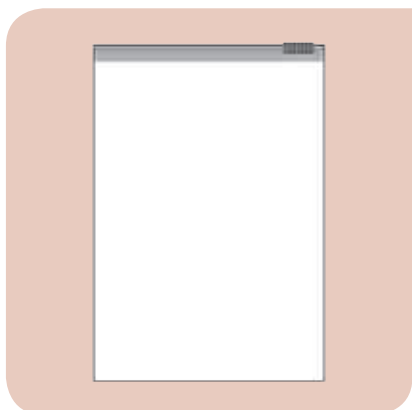



Beutel für Versand & Verpackung

Bags for shipping & packaging

Begleitpapiertaschen

Packing list envelopes

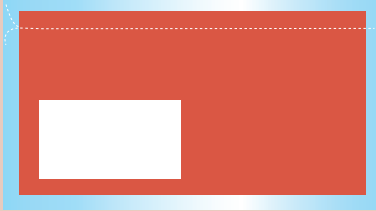

selbstklebend, transparent, rückseitig zum Befüllen geschlitzt
self-adhesive, transparent, slotted to fill from the back edge



Artikel-Nr. Item no.	Format Size	Ausführung Description
LT.C4.00	C4 (für Inhalt DIN A4) C4 (for A4)	neutral, unbedruckt, Schmalseite offen <i>neutral, unprinted, short edge open</i>
LT.C4.BS.00	C4 (für Inhalt DIN A4) C4 (for A4)	neutral, unbedruckt, Breitseite offen <i>neutral, unprinted, long edge open</i>
LT.C5.00	C5 (für Inhalt DIN A5) C5 (for A5)	neutral, unbedruckt <i>neutral, unprinted</i>
LT.C5.LS_RG.03	C5 (für Inhalt DIN A5) C5 (for A5)	rot, Aufdruck „Lieferschein / Rechnung“ <i>red pocket with black printing "Packing list / Invoice"</i>
LT.C6.00	C6 (für Inhalt DIN A6) C6 (for A6)	neutral, unbedruckt <i>neutral, unprinted</i>
LT.C6.LS_RG.03 ²	C6 (für Inhalt DIN A6) C6 (for A6)	rot, Aufdruck „Lieferschein / Rechnung“ <i>red pocket with black printing "Packing list / Invoice"</i>
LT.C7.00	C7 (für Inhalt DIN A7) C7 (for A7)	neutral, unbedruckt <i>neutral, unprinted</i>
LT.DIN_LANG.00 ¹	DIN-lang DL	neutral, unbedruckt <i>neutral, unprinted</i>
LT.DIN_LANG.LS.03	DIN-lang DL	rot, Aufdruck „Lieferschein“ <i>red pocket with black printing "Packing list"</i>
LT.DIN_LANG.LS_RG.03	DIN-lang DL	rot, Aufdruck „Lieferschein / Rechnung“ <i>red pocket with black printing "Packing list / Invoice"</i>
NEU LT.DIN_LANG.LS_RG.05 ³	DIN-lang DL	dunkelblau, Aufdruck „Lieferschein / Rechnung“ <i>dark blue pocket with black printing "Packing list / Invoice"</i>
NEU LT.DIN_LANG.LS_RG.07 ⁴	DIN-lang DL	grün, Aufdruck „Lieferschein / Rechnung“ <i>green pocket with black printing "Packing list / Invoice"</i>
NEU LT.DIN_LANG.LS_RG.08	DIN-lang DL	gelb, Aufdruck „Lieferschein / Rechnung“ <i>yellow pocket with black printing "Packing list / Invoice"</i>
NEU LT.DIN_LANG.LS_RG.09	DIN-lang DL	orange, Aufdruck „Lieferschein / Rechnung“ <i>orange pocket with black printing "Packing list / Invoice"</i>
NEU LT.DIN_LANG.LS_RG.10	DIN-lang DL	lila, Aufdruck „Lieferschein / Rechnung“ <i>purple pocket with black printing "Packing list / Invoice"</i>
NEU LT.DIN_LANG.LS_RG.12	DIN-lang DL	türkis, Aufdruck „Lieferschein / Rechnung“ <i>turquoise pocket with black printing "Packing list / Invoice"</i>

Begleitpapiertaschen nach Kundenwunsch

Packing list envelopes - customised



- Mindestmenge: 10.000 Stück
minimum quantity: 10,000 pieces
- Sonderformate in fast jeder gewünschten Abmessung, egal ob Schmalseite oder Breitseite offen
available in almost every desired size, short edge open or long edge open
- PE-Folien oder PP-Folien in unterschiedlicher Folienstärke
PE foil or PP foil in different thicknesses
- rückseitig zum Befüllen geschlitzt, überlappend oder mit Klebestreifen
slotted to fill from the back edge, overlapping or with adhesive strip
- Aufdruck im Flexodruck
overprinted by flexo



Beutel für Versand & Verpackung

Bags for shipping & packaging

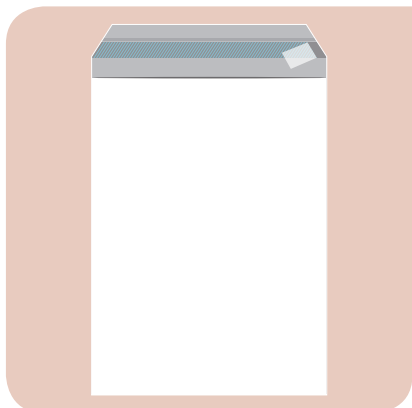



COEX-Klappenbeutel für den Versand

COEX bags with flap

Schmalseite offen, Klappe mit permanentem Klebeverschluss, PE-COEX-Folie, außen weiß, innen schwarz (blickdicht)

short edge open, flap with permanent adhesive strip, outside white, inside black (opaque)

Artikel-Nr. Item no.	Format Size	Klappe Flap	Folienstärke Foil thickness
KB.250350.PERM.COEX70	DIN B4, 250 x 350 mm B4, 250 x 350 mm	50 mm	70 µm 70 micron
 KB.300410.PERM.COEX50	300 x 410 mm 300 x 410 mm	40 mm	50 µm 50 micron
 KB.360500.PERM.COEX50	360 x 500 mm 360 x 500 mm	40 mm	50 µm 50 micron



Saugnapfe (Haftsauger)

Suction Cups

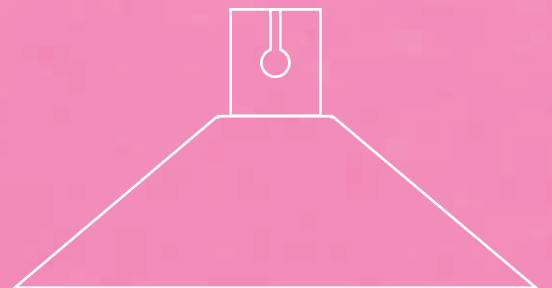
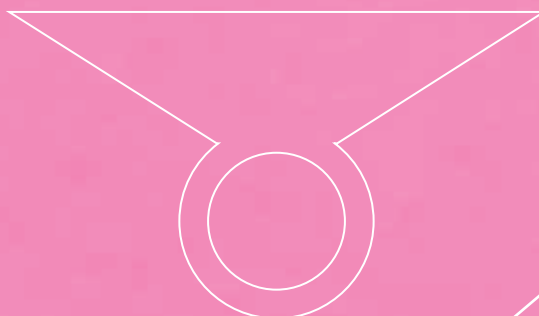
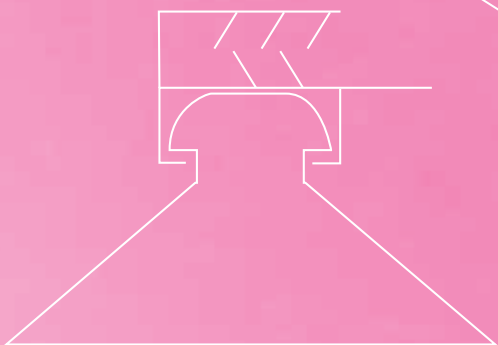
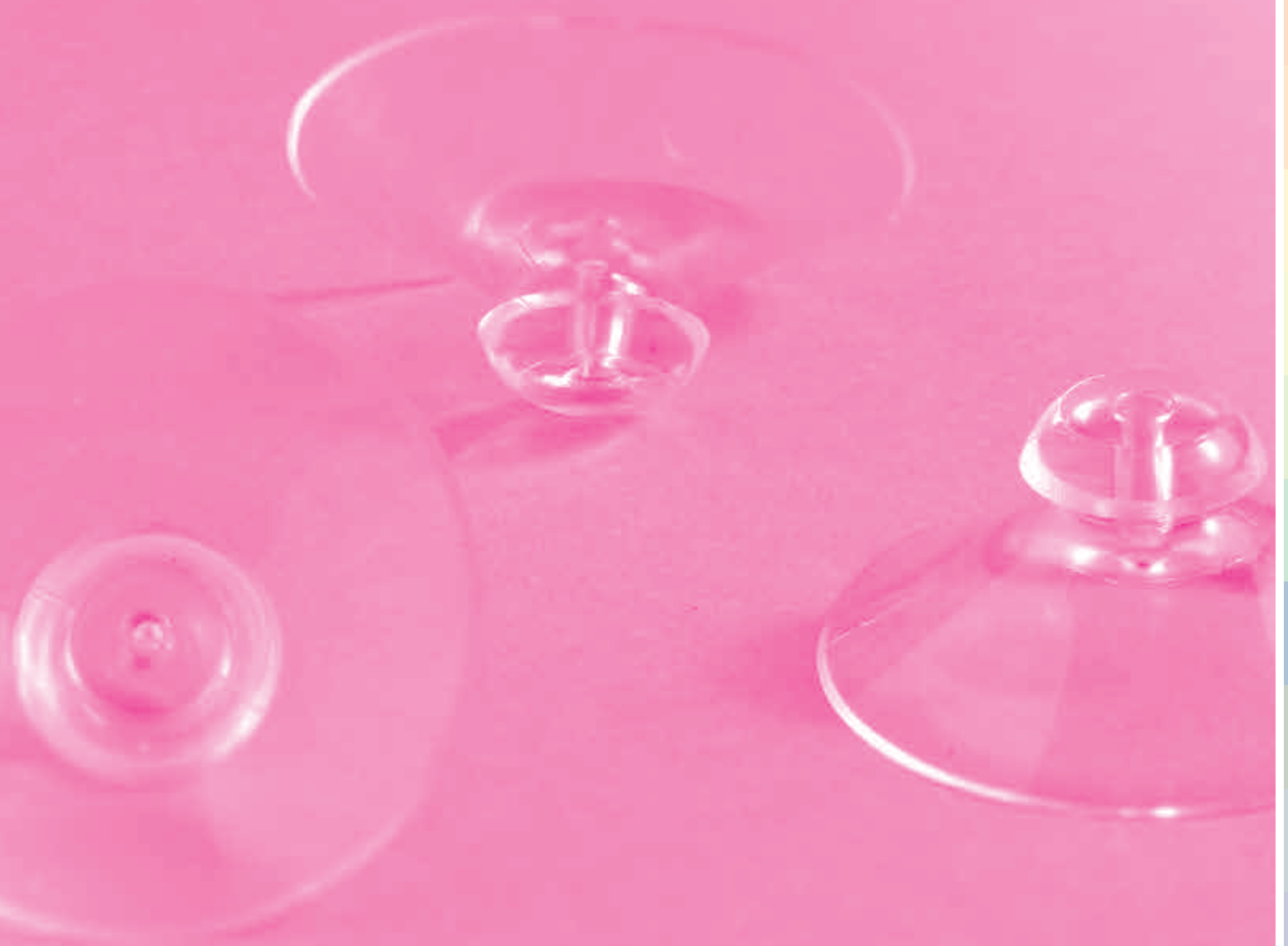
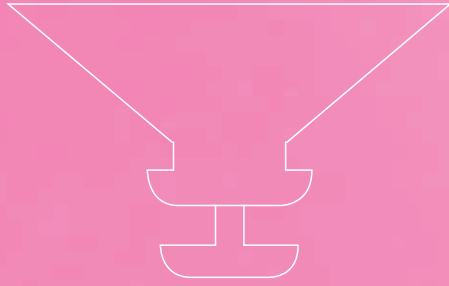
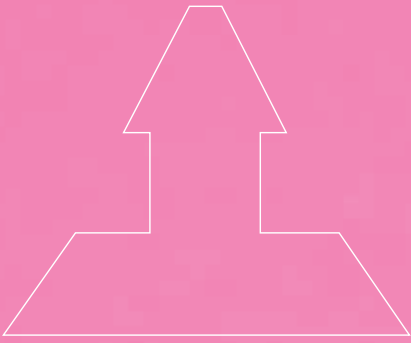



Saugnapfe (Haftsauger) Suction Cups



Saugnapfe mit Pfeilkopf Suction cups with arrow head

transparent
transparent

Artikel-Nr. | Item no. Durchmesser | Diameter

SN.14.P 14 mm

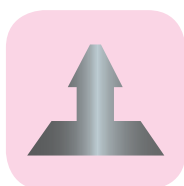

Saugnapfe mit Kopf Suction cups with mushroom head

transparent
transparent

Artikel-Nr. | Item no. Durchmesser | Diameter Kopf Durchmesser | Head diameter

SN.20.K 20 mm 8 mm

SN.30.K 30 mm 14 mm

SN.40.K 40 mm 14 mm

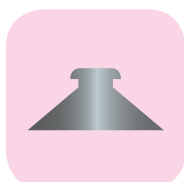

Saugnapfe mit Dorn zum Einstecken Suction cups with thumb tack

transparent
transparent

Artikel-Nr. | Item no. Durchmesser | Diameter

SET.SN.30.D 30 mm

SET.SN.40.D 40 mm

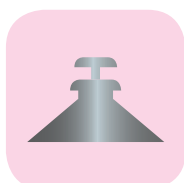



Saugnapfe (Haftsauger)

Suction Cups



Saugnapfe mit Metallhaken

Suction cups with metal hook

transparent
transparent

Artikel-Nr. Item no.	Durchmesser Diameter
SN.20.H	20 mm
SN.40.H ¹	40 mm

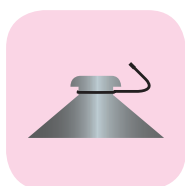

Saugnapfe mit M4-Gewinde

Suction cups with screw top (M4)

transparent, ohne Rändelmutter
transparent, without lock nut

Artikel-Nr. Item no.	Durchmesser Diameter	Gewindelänge Screw top length
SN.30.M4_6	30 mm	6 mm
SN.30.M4_10 ²	30 mm	10 mm
SN.40.M4_6	40 mm	6 mm
SN.40.M4_10	40 mm	10 mm
SN.50.M4_6	50 mm	6 mm
SN.50.M4_10	50 mm	10 mm



transparent, mit Rändelmutter
transparent, with lock nut

Artikel-Nr. Item no.	Durchmesser Diameter	Gewindelänge Screw top length	Rändelmutter Lock nut
SET.SN.30.6.00	30 mm	6 mm	☑ transparent transparent
SET.SN.30.6.1 ¹	30 mm	6 mm	☐ weiß white
SET.SN.30.10.00	30 mm	10 mm	☑ transparent transparent
SET.SN.30.10.01	30 mm	10 mm	☐ weiß white
SET.SN.40.6.00	40 mm	6 mm	☑ transparent transparent
SET.SN.40.6.01	40 mm	6 mm	☐ weiß white
SET.SN.40.10.00 ³	40 mm	10 mm	☑ transparent transparent
SET.SN.40.10.01	40 mm	10 mm	☐ weiß white
SET.SN.50.6.00	50 mm	6 mm	☑ transparent transparent
SET.SN.50.6.01	50 mm	6 mm	☐ weiß white
SET.SN.50.10.00	50 mm	10 mm	☑ transparent transparent
SET.SN.50.10.01	50 mm	10 mm	☐ weiß white

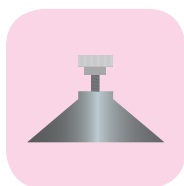



Saugnapfe (Haftsauger)

Suction Cups



Saugnapfe mit Kartenhalter

Suction cups with card holder

25 mm lang, transparent
length 25 mm, transparent

Artikel-Nr. Item no.	Durchmesser Diameter	Schildausrichtung Card direction
SN.25.KH.PARA ²	25 mm	parallel parallel
SN.25.KH.90G ¹	25 mm	90°-Winkel 90° angle

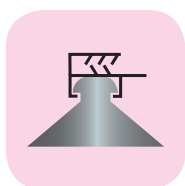

Weitere Saugnapfe

More suction cups

transparent
transparent

Artikel-Nr. Item no.	Durchmesser Diameter	Ausführung Description
SN.20.L ¹	20 mm	für Lichterketten for fairy lights
SN.30.R10.L ²	30 mm	mit Ring (Ringdurchmesser 10 mm) with ring (diameter 10 mm)

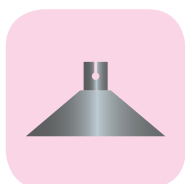

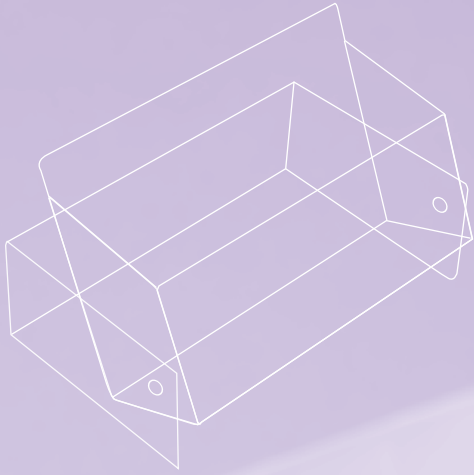



Foldback-Klammern

Fold back clips

Metall, schwarz, mit 2 Drahtbügeln

metal, black, with 2 wire clamps

Artikel-Nr. Item no.	Breite Width
FBK.15.02	15 mm
FBK.19.02	19 mm
FBK.25.02	25 mm
FBK.32.02	32 mm
FBK.41.02	41 mm
FBK.51.02	51 mm

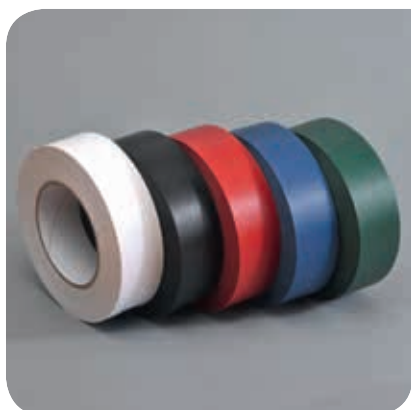

Best Price Fäzelband

Best Price spine tape

Spezialpapier mit Leinenstruktur, selbstklebend, 200 µm, auf Rolle mit 50 m

special tissue tape, self-adhesive, 200 micron, on rolls with 50 m

Artikel-Nr. Item no.	Breite Width	Farbe Colour
FZ.P.25.01	25 mm	☐ weiß white
FZ.P.25.02	25 mm	■ schwarz black
FZ.P.25.03 ¹	25 mm	■ rot red
FZ.P.25.04	25 mm	■ blau blue
FZ.P.25.07	25 mm	■ grün green
FZ.P.30.01	30 mm	☐ weiß white
FZ.P.30.02	30 mm	■ schwarz black
FZ.P.30.03	30 mm	■ rot red
FZ.P.30.04 ²	30 mm	■ blau blue
FZ.P.30.07	30 mm	■ grün green
FZ.P.38.01	38 mm	☐ weiß white
FZ.P.38.02	38 mm	■ schwarz black
FZ.P.38.03	38 mm	■ rot red
FZ.P.38.04	38 mm	■ blau blue
FZ.P.38.07 ³	38 mm	■ grün green
FZ.P.50.01	50 mm	☐ weiß white
FZ.P.50.02	50 mm	■ schwarz black
FZ.P.50.03	50 mm	■ rot red
FZ.P.50.04	50 mm	■ blau blue
FZ.P.50.07	50 mm	■ grün green
FZ.P.75.01	75 mm	☐ weiß white
FZ.P.75.02	75 mm	■ schwarz black

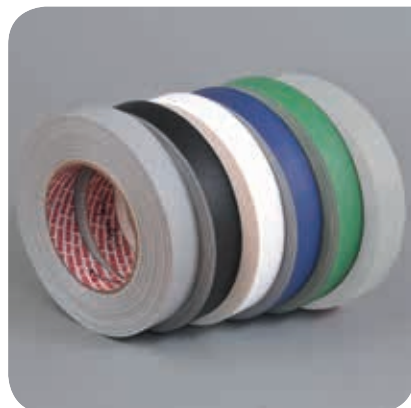

Fälzelband REGUtex R

Spine tape REGUtex R

hochwertiges Gewebeband, lackierte Oberfläche 250 µm, selbstklebend, auf Rollen mit 50 m
high-grade linen tape, varnished surface, 250 micron, self-adhesive, on rolls with 50 m

Artikel-Nr. Item no.	Breite Width	Farbe Colour	Stück / Packung Pieces / Pack
FZ.R.1950.01.8	19 mm	☐ weiß white	8
FZ.R.1950.02.8	19 mm	■ schwarz black	8
FZ.R.1950.04.8	19 mm	■ blau blue	8
FZ.R.1950.07.8	19 mm	■ grün green	8
FZ.R.1950.11.8	19 mm	■ grau grey	8
FZ.R.2550.01.6	25 mm	☐ weiß white	6
FZ.R.2550.02.6	25 mm	■ schwarz black	6
FZ.R.2550.04.6	25 mm	■ blau blue	6
FZ.R.2550.07.6	25 mm	■ grün green	6
FZ.R.2550.11.6	25 mm	■ grau grey	6
FZ.R.3050.01.5	30 mm	☐ weiß white	5
FZ.R.3050.02.5	30 mm	■ schwarz black	5
FZ.R.3050.04.5	30 mm	■ blau blue	5
FZ.R.3050.07.5	30 mm	■ grün green	5
FZ.R.3050.11.5	30 mm	■ grau grey	5
FZ.R.3850.01.4	38 mm	☐ weiß white	4
FZ.R.3850.02.4	38 mm	■ schwarz black	4
FZ.R.3850.04.4	38 mm	■ blau blue	4
FZ.R.3850.07.4	38 mm	■ grün green	4
FZ.R.3850.11.4	38 mm	■ grau grey	4
FZ.R.5050.01.3	50 mm	☐ weiß white	3
FZ.R.5050.02.3	50 mm	■ schwarz black	3
FZ.R.5050.04.3	50 mm	■ blau blue	3
FZ.R.5050.07.3	50 mm	■ grün green	3
FZ.R.5050.11.3	50 mm	■ grau grey	3
FZ.R.6050.01.2	60 mm	☐ weiß white	2
FZ.R.6050.02.2	60 mm	■ schwarz black	2
FZ.R.6050.04.2	60 mm	■ blau blue	2
FZ.R.6050.07.2	60 mm	■ grün green	2
FZ.R.6050.11.2	60 mm	■ grau grey	2

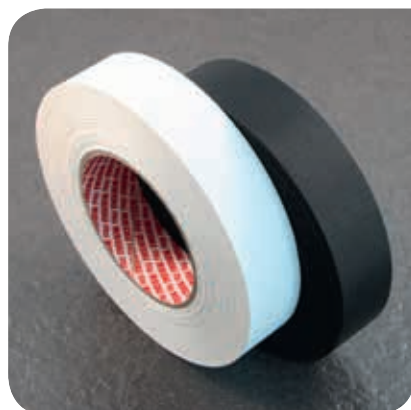

Fälzelband REGUdux RX

Spine Tape REGUdux RX

Kunststoffband mit Leinenoptik 300 µm, selbstklebend, auf Rollen mit 50 m
plastic tape with cloth effect, 300 micron, self-adhesive, on rolls with 50 m

Artikel-Nr. Item no.	Breite Width	Farbe Colour	Stück / Packung Pieces / Pack
FZ.RX.1950.01.8	19 mm	☐ weiß white	8
FZ.RX.1950.02.8	19 mm	■ schwarz black	8
FZ.RX.2550.01.6	25 mm	☐ weiß white	6
FZ.RX.2550.02.6	25 mm	■ schwarz black	6
FZ.RX.3050.01.5	30 mm	☐ weiß white	5
FZ.RX.3050.02.5	30 mm	■ schwarz black	5
FZ.RX.3850.01.4	38 mm	☐ weiß white	4
FZ.RX.3850.02.4	38 mm	■ schwarz black	4
FZ.RX.5050.01.3	50 mm	☐ weiß white	3
FZ.RX.5050.02.3	50 mm	■ schwarz black	3

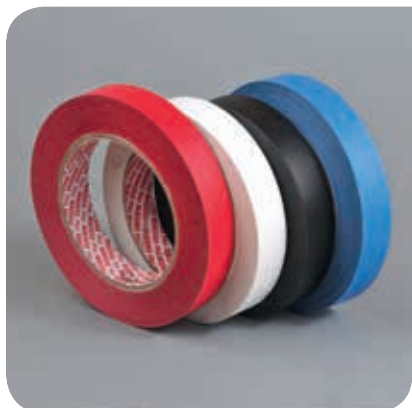

Fälzelband REGUtaf H3

Spine tape REGUtaf H3

feingenarbtetes Spezialfaserpapier 150 µm, selbstklebend, auf Rollen mit 50 m

fine-grained special fibre paper, 150 micron, self-adhesive, on rolls with 50 m

Artikel-Nr. Item no.	Breite Width	Farbe Colour	Stück / Packung Pieces / Pack
FZ.H3.1950.01.8	19 mm	□ weiß white	8
FZ.H3.1950.02.8	19 mm	■ schwarz black	8
FZ.H3.1950.03.8	19 mm	■ rot red	8
FZ.H3.1950.04.8	19 mm	■ blau blue	8
FZ.H3.2550.01.6	25 mm	□ weiß white	6
FZ.H3.2550.02.6	25 mm	■ schwarz black	6
FZ.H3.2550.03.6	25 mm	■ rot red	6
FZ.H3.2550.04.6	25 mm	■ blau blue	6
FZ.H3.3050.01.5	30 mm	□ weiß white	5
FZ.H3.3050.02.5	30 mm	■ schwarz black	5
FZ.H3.3050.03.5	30 mm	■ rot red	5
FZ.H3.3050.04.5	30 mm	■ blau blue	5
FZ.H3.3850.01.4	38 mm	□ weiß white	4
FZ.H3.3850.02.4	38 mm	■ schwarz black	4
FZ.H3.3850.03.4	38 mm	■ rot red	4
FZ.H3.3850.04.4	38 mm	■ blau blue	4
FZ.H3.5050.01.3	50 mm	□ weiß white	3
FZ.H3.5050.02.3	50 mm	■ schwarz black	3
FZ.H3.5050.03.3	50 mm	■ rot red	3
FZ.H3.5050.04.3	50 mm	■ blau blue	3

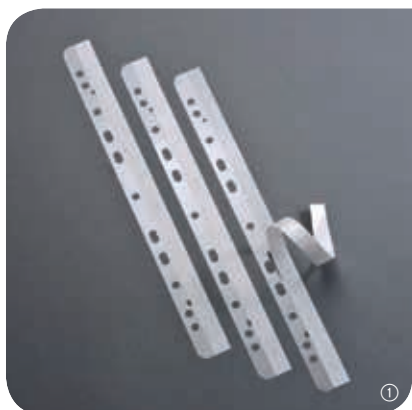

Selbstklebende Abheftstreifen

Self-adhesive filing strips

transparent

transparent



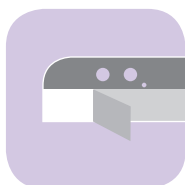

Artikel-Nr. Item no.	Format Size
AS.125025	125 x 25 mm, 4-fach gelocht 125 x 25 mm, 4-on-1 perforated
AS.295025 ¹	295 x 25 mm, 11-fach gelocht 295 x 25 mm, 11-on-1 perforated





Selbstklebende Abheftstreifen nach Kundenwunsch

Self-adhesive filing strips - customised

-  Mindestmenge: 250 Stück
minimum quantity: 250 pieces
-  Sonderformate in fast jeder gewünschten Abmessung
custom-made in nearly all desired sizes
-  verschiedene Folienarten, Folienstärken und Folienfarben, z.B. glasklar, matt, transluzent oder farbig.
available in different foil types, thicknesses and appearances, e.g. transparent, frosted, translucent or coloured
-  mit 2-fach, 4-fach oder kundenspezifischer Lochung
with 2-on-1, 4-on-1 perforation or customised
-  Aufdruck im Siebdruck, Offsetdruck oder mit (Blind)-Prägung
overprinted by silk screen printing, offset printing or with (blind) embossing





Elastikpuffer

Bumpers

selbstklebend

self-adhesive

Artikel-Nr. <i>Item no.</i>	Format <i>Size</i>	Ausführung <i>Description</i>	Farbe <i>Colour</i>
KP.EP.K.6_4.1_9.00	Durchmesser: 6,4 mm, Stärke: 1,9 mm <i>Diameter: 6,4 mm, Thickness 1,9 mm</i>	Halbkugel <i>hemispherical</i>	 transparent <i>transparent</i>
 KP.EP.K.6_4.1_9.02	Durchmesser: 6,4 mm, Stärke: 1,9 mm <i>Diameter: 6,4 mm, Thickness 1,9 mm</i>	Halbkugel <i>hemispherical</i>	 schwarz <i>black</i>
 KP.EP.S.8.1.00	Durchmesser: 8 mm, Stärke: 1 mm <i>Diameter: 8 mm, Thickness 1 mm</i>	Scheibe <i>disc</i>	 transparent <i>transparent</i>
KP.EP.S.8.1.02	Durchmesser: 8 mm, Stärke: 1 mm <i>Diameter: 8 mm, Thickness 1 mm</i>	Scheibe <i>disc</i>	 schwarz <i>black</i>
KP.EP.K.8.2_2.00	Durchmesser: 8 mm, Stärke: 2,2 mm <i>Diameter: 8 mm, Thickness 2,2 mm</i>	Halbkugel <i>hemispherical</i>	 transparent <i>transparent</i>
 KP.EP.K.8.2_2.02	Durchmesser: 8 mm, Stärke: 2,2 mm <i>Diameter: 8 mm, Thickness 2,2 mm</i>	Halbkugel <i>hemispherical</i>	 schwarz <i>black</i>
KP.EP.S.10.1.00	Durchmesser: 10 mm, Stärke: 1 mm <i>Diameter: 10 mm, Thickness 1 mm</i>	Scheibe <i>disc</i>	 transparent <i>transparent</i>
 KP.EPT.10.2_5.00 ²	10 x 10 x 2,5 mm	Trapez <i>trapezoid</i>	 transparent <i>transparent</i>
KP.EP.K.10.3_2.00	Durchmesser: 10 mm, Stärke: 3,2 mm <i>Diameter: 10 mm, Thickness 3,2 mm</i>	Halbkugel <i>hemispherical</i>	 transparent <i>transparent</i>
 KP.EP.K.10.3_2.02	Durchmesser: 10 mm, Stärke: 3,2 mm <i>Diameter: 10 mm, Thickness 3,2 mm</i>	Halbkugel <i>hemispherical</i>	 schwarz <i>black</i>
 KP.EP.K.11_1.5.00	Durchmesser: 11,1 mm, Stärke: 5 mm <i>Diameter: 11,1 mm, Thickness 5 mm</i>	Halbkugel <i>hemispherical</i>	 transparent <i>transparent</i>
 KP.EP.S.12_7.1_8.00	Durchmesser: 12,7 mm, Stärke: 1,8 mm <i>Diameter: 12,7 mm, Thickness 1,8 mm</i>	Scheibe <i>disc</i>	 transparent <i>transparent</i>
 KP.EPT.12_7.3_1.00	12,7 x 12,7 x 3,1 mm	Trapez <i>trapezoid</i>	 transparent <i>transparent</i>
KP.EP.K.16.7_9.00 ¹	Durchmesser: 16 mm, Stärke: 7,9 mm <i>Diameter: 16 mm, Thickness 7,9 mm</i>	Halbkugel <i>hemispherical</i>	 transparent <i>transparent</i>
 KP.EP.K.16.7_9.02	Durchmesser: 16 mm, Stärke: 7,9 mm <i>Diameter: 16 mm, Thickness 7,9 mm</i>	Halbkugel <i>hemispherical</i>	 schwarz <i>black</i>
 KP.EP.S.19.1_9.00 ³	Durchmesser: 19 mm, Stärke: 1,9 mm <i>Diameter: 19 mm, Thickness 1,9 mm</i>	Scheibe <i>disc</i>	 transparent <i>transparent</i>
 KP.EP.K.19.9_5.00	Durchmesser: 19 mm, Stärke: 9,5 mm <i>Diameter: 19 mm, Thickness 9,5 mm</i>	Halbkugel <i>hemispherical</i>	 transparent <i>transparent</i>

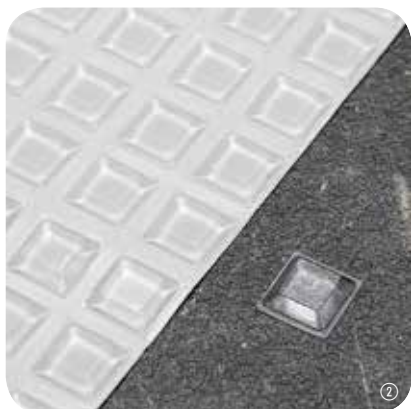

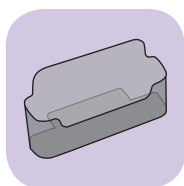

Visitenkartenhalter

Business card holders

Querformat, Polystyrol, transparent
horizontal, made of PS, transparent

Artikel-Nr. Item no.	Format Size	Ausführung Description
VX.A.1F.BS ¹	95 x 50 x 20 mm	1-fach 1 tier
VX.A.8F.BS ²	199 x 89 x 98 mm	8 Fächer, 4 Etagen 8 pockets, 4 tier

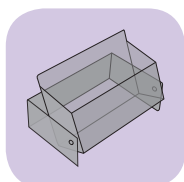

Visitenkartenboxen

Business card boxes

aufstellbar, Polystyrol transparent
collapsible, made of PS, transparent

Artikel-Nr. Item no.	Format Size
VX.096061.31.A.00	96 x 61 x 31 mm
VX.096061.40.A.00	96 x 61 x 40 mm

Außerdem im Angebot | Also available
 Visitenkartenbox als Kalenderbox (siehe Seite 4.3)
 business card boxes as calendar boxes (see page 4.3)

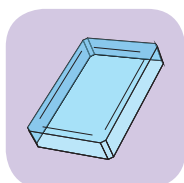

Spielkartenschachteln

Playing card boxes

aus transparentem PP, 2-teilig, bestehend aus Boden und Deckel
with base and lid, transparent, made of PP

Artikel-Nr. Item no.	Breite Width
SS.097067.15.00	97 x 67 x 15 mm
SS.097067.25.00	97 x 67 x 25 mm

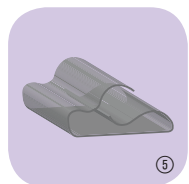
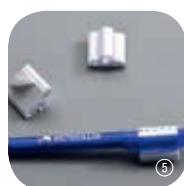

Stifthalter

Pen-holders

selbstklebend

self-adhesive

Artikel-Nr. Item no.	Grundfläche Base area	Ausführung Description
KG.012014.15.00	12 x 14 mm	15 mm hoch, milchig-transparent 15 mm high, clear frosted
KG.012015.12.00 ¹	12 x 15 mm	12 mm hoch, transparent 12 mm high, transparent
KG.012015.12.01	12 x 15 mm	12 mm hoch, weiß 12 mm high, white
KG.012015.12.02	12 x 15 mm	12 mm hoch, schwarz 12 mm high, black
KG.012015.12.06	12 x 15 mm	12 mm hoch, vernickelt 12 mm high, nickel-plated
KG.020025.12.00	25 x 25 mm	12 mm hoch, transparent 12 mm high, transparent
KG.020025.12.01 ⁵	25 x 25 mm	12 mm hoch, weiß 12 mm high, white
KG.020025.12.02	25 x 25 mm	12 mm hoch, schwarz 12 mm high, black

aus Metall, selbstklebend

metal, self-adhesive

KG.20.SK.D.06	ø 20 mm	mit flexibler Schlaufe, drehbar with flexible loop, rotatable
KG.20.SK.06 ²	ø 20 mm	mit flexibler Schlaufe with flexible loop
KG.032013.NT.D.06	32 x 13 mm	zum Einnieten, flexible Schlaufe, drehbar or riveting, flexible loop, rotatable
KG.032013.NT.S.06	32 x 13 mm	zum Einnieten, flexible Schlaufe, senkrecht fixiert for riveting, flexible loop, vertical fixed
KG.032013.NT.Q.06	32 x 13 mm	zum Einnieten, flexible Schlaufe, quer fixiert or riveting, flexible loop, horizontal fixed
KG.038040.C.3S.06	38 x 40 mm	Clip zum Einstecken, drei flexible Schlaufen o clip on, three flexible loops
KG.040011.C.1S.06	40 x 11 mm	Clip zum Einstecken, flexible Schlaufe to clip on, flexible loop
KG.040025.C.2S.06	40 x 25 mm	Clip zum Einstecken, zwei flexible Schlaufen to clip on, two flexible loops

mit Gummizugschlaufe aus Flachgummi, Klebefläche trapezförmig, selbstklebend

wire flat elastic-loop, adhesive part trapez shape, self-adhesive

NEU KG.GZ.30.15.SK.01	45 x 30 mm	<input type="checkbox"/> weiß für dünne Stifte white for thin pens
NEU KG.GZ.30.15.SK.02	45 x 30 mm	<input checked="" type="checkbox"/> schwarz dünne Stifte black for thin pens
NEU KG.GZ.30.15.SK.04	45 x 30 mm	<input checked="" type="checkbox"/> mittelblau mid blue
NEU KG.GZ.30.15.SK.05	45 x 30 mm	<input checked="" type="checkbox"/> dunkelblau dark blue
NEU KG.GZ.30.15.SK.03	45 x 30 mm	<input checked="" type="checkbox"/> rot red
NEU KG.GZ.30.15.SK.11	45 x 30 mm	<input checked="" type="checkbox"/> grau grey
KG.GZ.40.15.SK.01 ³	45 x 30 mm	<input type="checkbox"/> weiß white
KG.GZ.40.15.SK.02	45 x 30 mm	<input checked="" type="checkbox"/> schwarz black
KG.GZ.40.15.SK.03	45 x 30 mm	<input checked="" type="checkbox"/> rot red
KG.GZ.40.15.SK.04	45 x 30 mm	<input checked="" type="checkbox"/> mittelblau mid blue
KG.GZ.40.15.SK.05	45 x 30 mm	<input checked="" type="checkbox"/> blau blue
KG.GZ.40.15.SK.07	45 x 30 mm	<input checked="" type="checkbox"/> grün mid green
KG.GZ.40.15.SK.08	45 x 30 mm	<input checked="" type="checkbox"/> gelb yellow
KG.GZ.40.15.SK.09	45 x 30 mm	<input checked="" type="checkbox"/> orange orange
KG.GZ.40.15.SK.11	45 x 30 mm	<input checked="" type="checkbox"/> grau grey
KG.GZ.40.15.SK.14	45 x 30 mm	<input checked="" type="checkbox"/> bordeaux-rot bordeaux-red
KG.GZ.40.15.SK.17	45 x 30 mm	<input checked="" type="checkbox"/> braun brown

mit Schlaufe

loop

KG.040080.SK.WPVC018 ⁴	Schlaufe (20 mm breit), Klebefläche 40 x 60 mm loop (20 mm wide), adhesive surface 40 x 60 mm
-----------------------------------	--

mit Cliphaken für dünne Stifte

with clip-hook for thin pens

KG.20.H.01	ø 20 mm	<input type="checkbox"/> weiß white
------------	---------	---------------------------------------



PVC-Ringbücher

Ring binders







weiß, für Inhalt DIN A4, mit vollflächigen Taschen auf Vorderdeckel und Rücken
white, for A4, with full-format pockets at the cover an spine

Artikel-Nr. Item no.	Mechanik Mechanism	Füllhöhe Filling level	Rückenbreite Spine width
RB.20.2.01	2-Ring Combi 2-ring combi	20 mm	30 mm
RB.20.4.01	4-Ring Combi 4-ring combi	20 mm	30 mm
RB.30.2.01	2-Ring Combi 2-ring combi	30 mm	40 mm
RB.30.4.01	4-Ring Combi 4-ring combi	30 mm	40 mm
RB.40.2.01	2-Ring Combi 2-ring combi	40 mm	50 mm
RB.40.4.01	4-Ring Combi 4-ring combi	40 mm	50 mm
RB.50.2.01	2-Ring Combi 2-ring combi	50 mm	70 mm
RB.50.4.01	4-Ring Combi 4-ring combi	50 mm	70 mm



PVC-Schnellhefter nach Kundenwunsch

File folders - customised

-  Mindestmenge: 250 Stück
minimum quantity: 250 pieces
-  Formate in fast jeder gewünschten Abmessung
custom-made in nearly all desired sizes
-  kundenspezifisch aufgeschweißte Taschen (z.B. vollflächige Tasche im Vorderdeckel)
customer-specific welded-on pockets (e.g. with full-format pocket at the front)
-  mit oder ohne ausschließbare Abheftvorrichtung
with or without slidable filing strip
-  Abschweißungen / Aufschweißungen für mehrere Taschen
welded or welded-on pockets
-  verschiedene Folienarten, Folienstärken und Folienfarben, z.B. glasklar, matt, transluzent oder farbig
available in different foil types, thicknesses and appearances, e.g. transparent, frosted, translucent or coloured
-  Aufdruck im Siebdruck, Offsetdruck oder mit (Blind)-Prägung
overprint by silk screen printing, offset printing or (blind) embossing





Papierbohrer

Paper drill bits

vakuumgehärteter Werkzeugstahl

high quality steel

Artikel-Nr. Item no.	Bohr-Ø Hole diameter	Schaft-Ø Shaft diameter	Nutzlänge Drilling length	Beschichtung Coating
BO.020.22.11.GC	2 mm	11 mm	22 mm	Gleitschicht glide coating
BO.020.22.11.ST	2 mm	11 mm	22 mm	Standard standard
BO.020.22.11.TI	2 mm	11 mm	22 mm	Titan titanium
BO.025.24.11.GC	2,5 mm	11 mm	24 mm	Gleitschicht glide coating
BO.025.24.11.ST	2,5 mm	11 mm	24 mm	Standard standard
BO.025.24.11.TI	2,5 mm	11 mm	24 mm	Titan titanium
BO.030.32.11.GC	3 mm	11 mm	32 mm	Gleitschicht glide coating
BO.030.32.11.ST	3 mm	11 mm	32 mm	Standard standard
BO.030.32.11.TI	3 mm	11 mm	32 mm	Titan titanium
BO.035.32.11.GC	3,5 mm	11 mm	32 mm	Gleitschicht glide coating
BO.035.32.11.ST	3,5 mm	11 mm	32 mm	Standard standard
BO.035.32.11.TI	3,5 mm	11 mm	32 mm	Titan titanium
BO.040.42.11.GC	4 mm	11 mm	42 mm	Gleitschicht glide coating
BO.040.42.11.ST	4 mm	11 mm	42 mm	Standard standard
BO.040.42.11.TI	4 mm	11 mm	42 mm	Titan titanium
BO.045.42.11.GC	4,5 mm	11 mm	42 mm	Gleitschicht glide coating
BO.045.42.11.ST	4,5 mm	11 mm	42 mm	Standard standard
BO.045.42.11.TI	4,5 mm	11 mm	42 mm	Titan titanium
BO.050.52.11.GC	5 mm	11 mm	52 mm	Gleitschicht glide coating
BO.050.52.11.ST	5 mm	11 mm	52 mm	Standard standard
BO.050.52.11.TI	5 mm	11 mm	52 mm	Titan titanium
BO.055.52.11.GC	5,5 mm	11 mm	52 mm	Gleitschicht glide coating
BO.055.52.11.ST	5,5 mm	11 mm	52 mm	Standard standard
BO.055.52.11.TI	5,5 mm	11 mm	52 mm	Titan titanium
BO.060.52.11.GC	6 mm	11 mm	52 mm	Gleitschicht glide coating
BO.060.52.11.ST	6 mm	11 mm	52 mm	Standard standard
BO.060.52.11.TI	6 mm	11 mm	52 mm	Titan titanium
BO.065.52.11.GC	6,5 mm	11 mm	52 mm	Gleitschicht glide coating
BO.065.52.11.ST	6,5 mm	11 mm	52 mm	Standard standard
BO.065.52.11.TI	6,5 mm	11 mm	52 mm	Titan titanium
BO.070.52.11.GC	7 mm	11 mm	52 mm	Gleitschicht glide coating
BO.070.52.11.ST	7 mm	11 mm	52 mm	Standard standard
BO.070.52.11.TI	7 mm	11 mm	52 mm	Titan titanium
BO.075.52.11.ST	7,5 mm	11 mm	52 mm	Standard standard
BO.080.52.11.GC	8 mm	11 mm	52 mm	Gleitschicht glide coating
BO.080.52.11.ST	8 mm	11 mm	52 mm	Standard standard
BO.080.52.11.TI	8 mm	11 mm	52 mm	Titan titanium
BO.085.52.11.ST	8,5 mm	11 mm	52 mm	Standard standard
BO.090.52.11.GC	9 mm	11 mm	52 mm	Gleitschicht glide coating
BO.090.52.11.ST	9 mm	11 mm	52 mm	Standard standard
BO.090.52.11.TI	9 mm	11 mm	52 mm	Titan titanium
BO.100.52.16.ST	10 mm	16 mm	52 mm	Standard standard
BO.110.52.16.ST	11 mm	16 mm	52 mm	Standard standard
BO.120.52.16.ST	12 mm	16 mm	52 mm	Standard standard
BO.140.52.16.ST	14 mm	16 mm	52 mm	Standard standard
BO.150.60.24.ST	15 mm	24 mm	60 mm	Standard standard
BO.160.60.24.ST	16 mm	24 mm	60 mm	Standard standard
BO.180.60.24.ST	18 mm	24 mm	60 mm	Standard standard
BO.200.60.24.ST	20 mm	24 mm	60 mm	Standard standard



Wachspapierstreifen für Papierbohrer
Waxed paper stripes for paper drill bits

Artikel-Nr. | Item no. **Format | Size**

BO.WP.296065 296 x 65 mm



Bohrpappe
Drilling cardboard

Artikel-Nr. | Item no. **Format | Size** **Farbe | Colour**

BO.PAPPE.A4 DIN A4 | DIN A4 ■ schwarz | black



Falzbeine
Folding tool



aus Knochen
made of bones

Artikel-Nr. | Item no. **Format | Size** **Ausführung | Description**

BU.FA.120.S.01 120 mm spitz / rund | sharp / round

BU.FA.140.S.01 140 mm spitz / rund | sharp / round

BU.FA.160.R.01 ¹ 160 mm beidseitig rund | round on both sides

BU.FA.160.S.01 ² 160 mm spitz / rund | sharp / round

BU.FA.180.R.01 180 mm beidseitig rund | round on both sides

BU.FA.180.S.01 180 mm spitz / rund | sharp / round

BU.FA.200.S.01 200 mm spitz / rund | sharp / round



Zeilenmaß (Typometer)

Line gauge

NEU
now in stock

Zeilenmaß, rostfrei, biegsam, Zentimeter und Didot-System

Line gauge, stainless steel, flexible, centimetre and didot-system

Artikel-Nr. | Item no. Format | Size

BU.ZM.300.06 30 cm

BU.ZM.500.06 50 cm







Gehwegaufsteller, DIN A1

Pavement board for A1

doppelseitig, Aluminium silber, 32 mm Profil, runde Ecken

double-sided, aluminium silver, 32 mm profile, corners rounded

Artikel-Nr. Item no.	für Inhalt for inserts	Sichtmaß Visible size
------------------------	--------------------------	-------------------------

WT.AB.A1.32.R.06	DIN A1, 594 x 841 mm	575 x 820 mm
------------------	----------------------	--------------



Deckblätter DIN A1

Binding covers A1

passend für Gehwegaufsteller und Klapprahmen, PVC 450 µm, transparent, anti-reflex

for pavement board and snap frames, PVC 450 micron, transparent, anti-reflection

Artikel-Nr. Item no.	Format Size
------------------------	---------------

WT.AB.A1.DB.10	594 x 841 mm
----------------	--------------





Klapprahmen
Snap frame

Aluminium silber, 25 mm Profil, Ecken auf Gehrung geschnitten
aluminium silver, 25 mm profile, corners mitered

Artikel-Nr. <i>Item no.</i>	für Inhalt <i>for inserts</i>	Außenformat <i>Outer size</i>	Sichtmaß <i>Visible size</i>
WT.KR.B2.25.L.G.06	DIN B2, 500 x 700 mm	530 x 730 mm	480 x 680 mm
WT.KR.A4.25.L.G.06	DIN A4, 210 x 297 mm	240 x 330 mm	190 x 280 mm
WT.KR.A3.25.L.G.06 ¹	DIN A3, 297 x 420 mm	330 x 450 mm	278 x 400 mm
WT.KR.A2.25.L.G.06	DIN A2, 420 x 594 mm	450 x 625 mm	400 x 575 mm
WT.KR.A1.25.L.G.06	DIN A1, 594 x 841 mm	625 x 870 mm	575 x 820 mm



Magnetrahmen mit Magnetband
Magnetic frames with magnetic tape

Hart-PVC 250 µm, silber
rigid PVC 250 micron, silver

Artikel-Nr. <i>Item no.</i>	für Inhalt <i>for inserts</i>
MT.MR.A4.06	DIN A4, 210 x 297 mm
MT.MR.A3.06 ¹	DIN A3, 297 x 420 mm

selbstklebend
self-adhesive

Artikel-Nr. <i>Item no.</i>	für Inhalt <i>for inserts</i>	Außenformat <i>Outer size</i>	Sichtmaß <i>Visible size</i>	Farbe <i>Colour</i>
MT.MR.A4.SK.A.02 ³	DIN A4, 210 x 297 mm	325 x 240 mm	290 x 204 mm	■ schwarz <i>black</i>
MT.MR.A4.SK.A.06	DIN A4, 210 x 297 mm	325 x 240 mm	290 x 204 mm	■ silber <i>silver</i>
MT.MR.A3.SK.A.06 ²	DIN A3, 297 x 420 mm	448 x 325 mm	412 x 289 mm	■ silber <i>silver</i>



Geschäftsführung

Management



Matthias Schenk
Geschäftsführer
CEO

Telefon | phone +49 (0) 931 40416-0
E-Mail | email ms@sprintis.de



Christian Schenk
Geschäftsführer
CEO

Telefon | phone +49 (0) 931 40416-0
E-Mail | email cs@sprintis.de



Holger Heusinger
Prokurist
CEO

Telefon | phone +49 (0) 931 40416-118
E-Mail | email hh@sprintis.de



Lisa Schalme
Managementassistentin
Management assistant

Telefon | phone +49 (0) 931 40416-157
E-Mail | email lis@sprintis.de



Kundenberater

Customer care



Simon Giegerich
Teamleiter
Head of customer advice

Telefon | phone +49 (0) 931 40416-119
E-Mail | email sg@sprintis.de



Johannes Blümm
Teamleiter
Head of customer advice

Telefon | phone +49 (0) 931 40416-116
E-Mail | email jb@sprintis.de



Rita Schenk
Kundenberaterin
Customer consultant

Telefon | phone +49 (0) 931 40416-111
E-Mail | email rs@sprintis.de



Stefan Pohl
Kundenberater
Customer consultant

Telefon | phone +49 (0) 931 40416-126
E-Mail | email sp@sprintis.de



Johannes Dotzer
Kundenberater
Customer consultant

Telefon | phone +49 (0) 931 40416-124
E-Mail | email jd@sprintis.de



Kathrin Faulhaber
Kundenberaterin
Customer consultant

Telefon | phone +49 (0) 931 40416-132
E-Mail | email kf@sprintis.de



Dieter Kuhn
Kundenberater
Customer consultant

Telefon | phone +49 (0) 931 40416-141
E-Mail | email dk@sprintis.de



Jens Hehn
Kundenberater
Customer consultant

Telefon | phone +49 (0) 931 40416-135
E-Mail | email jh@sprintis.de



Johann Fischer
Kundenberater
Customer consultant

Telefon | phone +49 (0) 931 40416-152
E-Mail | email jf@sprintis.de



Verena Hoffmann
Kundenberaterin
Customer consultant

Telefon | phone +49 (0) 931 40416-156
E-Mail | email vh@sprintis.de



Nadine Fiolka
Kundenberaterin
Customer consultant

Telefon | phone +49 (0) 931 40416-158
E-Mail | email nf@sprintis.de



Alexander Schuller
Kundenberater
Customer consultant

Telefon | phone +49 (0) 931 40416-149
E-Mail | email asc@sprintis.de



Sebastian Straßberger
Kundenberater
Customer consultant

Telefon | phone +49 (0) 931 40416-167
E-Mail | email ses@sprintis.de





Vertriebsbüro Stuttgart

Sales office Stuttgart



Thomas Seifert
Kundenberater
Customer consultant

Telefon | phone +49 (0) 931 40416-211
E-Mail | email ts@sprintis.de

Adresse | address
Stuttgarter Straße 133
73230 Kirchheim / Teck



Vertriebsbüro Benelux

Sales office Benelux



Paul Spitzen
Kundenberater
Customer consultant

Telefon | phone +31 (0) 85 877-1356
Fax | fax +31 (0) 85 877-2380
E-Mail | email ps@sprintis.nl

Adresse | address
Zaanweg 65 III
1521 DM Wormerveer



Francis Hoogmoed
Kundenberaterin
Customer consultant

Telefon | phone +31 (0) 85 877-1356
Fax | fax +31 (0) 85 877-2380
E-Mail | email fh@sprintis.nl

Adresse | address
Zaanweg 65 III
1521 DM Wormerveer



Export

Export



Peter Dashwood-Howard
Export
Export

Telefon | phone +49 (0) 931 40416-146
E-Mail | email pdh@sprintis.de



Vertrieb Backoffice

Customer care backoffice



Michael Eichler
Teamleiter Vertrieb Backoffice
Head of customer care backoffice

Telefon | phone +49 (0) 931 40416-139
E-Mail | email me@sprintis.de



Kerstin Hubert
Vertrieb Backoffice
Customer care backoffice

Telefon | phone +49 (0) 931 40416-133
E-Mail | email kh@sprintis.de



Julia Sippel
Vertrieb Backoffice
Customer care backoffice

Telefon | phone +49 (0) 931 40416-151
E-Mail | email js@sprintis.de



Ramona Berninger
Vertrieb Backoffice
Customer care backoffice

Telefon | phone +49 (0) 931 40416-136
E-Mail | email rb@sprintis.de



Kristin Schwarzkopf
Vertrieb Backoffice
Customer care backoffice

Telefon | phone +49 (0) 931 40416-142
E-Mail | email ksc@sprintis.de



Stefan Tscheschel
Vertrieb Backoffice
Customer care backoffice

Telefon | phone +49 (0) 931 40416-163
E-Mail | email st@sprintis.de



Versand und Lager

Storage and dispatch



Christian Holl
Lagerleiter
Warehouse manager

Telefon | phone +49 (0) 931 40416-150
E-Mail | email ch@sprintis.de



Sascha Bätz
Stellvertretender Lagerleiter
Deputy warehouse manager

Telefon | phone +49 (0) 931 40416-192
E-Mail | email sb@sprintis.de





Einkauf Purchasing



Andreas Thorwart
Teamleiter Einkauf
Head of purchasing

Telefon | phone +49 (0) 931 40416-117
E-Mail | email at@sprintis.de



Frank Sellinat
Strategischer Einkäufer
Strategic buyer

Telefon | phone +49 (0) 931 40416-160
E-Mail | email fs@sprintis.de



Nadine Yavuz
Sachbearbeiterin Einkauf
Purchasing administrator

Telefon | phone +49 (0) 931 40416-144
E-Mail | email ny@sprintis.de



Julian Weber
Sachbearbeiter Einkauf
Purchasing administrator

Telefon | phone +49 (0) 931 40416-140
E-Mail | email jw@sprintis.de



Marketing Marketing



Oliver Koch
Teamleiter Marketing
Head of marketing

Telefon | phone +49 (0) 931 40416-143
E-Mail | email ok@sprintis.de



Maria Bethge
Marketing
Marketing

Telefon | phone +49 (0) 931 40416-128
E-Mail | email mb@sprintis.de



Daniela Philipp
Marketing
Marketing

Telefon | phone +49 (0) 931 40416-148
E-Mail | email dp@sprintis.de



Buchhaltung Accounting



Martin Göbel
Teamleiter Buchhaltung
Head of accounting

Telefon | phone +49 (0) 931 40416-138
E-Mail | email mg@sprintis.de



Jana Götzelmann
Buchhaltung
Accounting

Telefon | phone +49 (0) 931 40416-115
E-Mail | email jag@sprintis.de



Kilian Thönnies
Buchhaltung
Accounting

Telefon | phone +49 (0) 931 40416-127
E-Mail | email kt@sprintis.de



Andrea Gebert
Controlling
Controlling

Telefon | phone +49 (0) 931 40416-171
E-Mail | email ag@sprintis.de





**Kollektion mit weit über 130 verschiedenen
Produktmustern aus unserem Lieferprogramm**

Musterkollektion



Aufwendige Kollektion mit mehr als **130 verschiedenen Produktmustern** aus dem SPRINTIS Lieferprogramm!

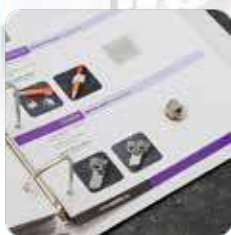

Zweisprachige Ausgabe.



Umfassende Lösungen für Ihre Problemstellungen.

* Der Betrag von 19,90 € ist als Schutzgebühr zu verstehen. Die tatsächlichen Produktionskosten sind um ein Vielfaches höher. Bitte haben Sie aus diesem Grund Verständnis, dass wir maximal eine Musterkollektion pro Kunde versenden können.



Glossar Glossary

A

Abdeckkappen für Buchschrauben	9.5
Abdeckschienen für Heftmechaniken	1.1
Abhängefedern JetSnabb	11.6
Abheftstreifen für Draht- und Plastikbinderücken	8.8
Abheftvorrichtungen mit 2 Ösen	1.3
Abheftvorrichtungen mit 4 Ösen	1.4
Ablagehüllen aus PP-Folie	14.1
Abschnitte aus Gummizugschnur	12.7
Abschnitte Lesezeichenband und Kordeln nach Kundenwunsch	12.9
Abstandshalter	11.3
Adhesive discs - customised	5.2
Aktionsetiketten	5.3
Archivclips	1.5
Archive clips	1.5
Arrow clips	4.6
Arrow clips - customised	4.6
Atlaskordeln auf Rolle	12.8
Aufhängehaken	11.7
Aufhängeösen	9.11
Ausweishüllen	14.9
Ausweishüllen mit farbigem Hängerand	14.8
Ausweishüllen nach Kundenwunsch	14.9

B

Back covers	8.8
Back support	11.11
Badge reel made of plastic	14.10
Bags with flap, with warning imprint, PP foil 40 micron	15.4
Bags with flap - customised	15.7
Ball chain connectors	9.17
Ball chain reels	9.15
Ball chains, cut-to-length	9.16
Bannerhalter mit Magnetbasis	11.10
Banner holder with magnetic base	11.10
Begleitpapiertaschen	15.11
Begleitpapiertaschen nach Kundenwunsch	15.11
Best Price Fäzelband	17.1
Best Price spine tape	17.1
Bindestifte mit Verschlussöse	10.6
Bindestifte mit Verschlusscheibe	10.6
Binding covers	8.7
Binding covers A1	18.1
Binding covers - customised	8.7
Binding rings	9.10
Binding screw hangers	9.11
Binding screws, black painted head	9.4
Binding screws, black zinc-plated	9.3
Binding screws, brass-plated	9.2
Binding screws, copper-plated	9.3
Binding screws, nickel-plated	9.1
Binding screws with rosette disc	9.4
Bilsterleisten	11.10
Bohrpappe	17.10
Bottle rings	11.4
Braided cords with hooks	12.9
Brochure holder	11.12
Buchecken	9.9
Buchecken-Werkzeug Set	9.10
Bucheckenzange	9.9
Buchschrauben, Kopf schwarz lackiert	9.4
Buchschrauben, schwarz verzinkt	9.3
Buchschrauben, vermessingt	9.2
Buchschrauben, vernickelt	9.1
Buchschrauben mit Rosettenscheibe	9.4
Bumpers	17.4
Business card and rectangular pockets - customised	2.5
Business card boxes	17.5
Business card holders	17.5
Business card pockets	2.4

C

Calendar boxes	4.3
Calendar hangers	4.7
Card holders	11.4
CD-Ablagehüllen	3.3
CD-Clips	3.1
CD filing pockets	3.3
CD foam studs	3.1
CD-Halter aus Schaumstoff	3.1
CD holders	3.1
CD pockets	3.2
CD pockets - customised	3.2
CD-Taschen	3.2
CD-Taschen nach Kundenwunsch	3.2
CD-Trays	3.3
C-Haken	11.7
C-handles made of metal	10.2
C-hooks	11.7
C-Hüllen	14.6
Clasps for ball chain	9.17
COEX bags with flap	15.12
COEX-Klappenbeutel für den Versand	15.12
Coloured adhesive discs	5.4
Combi clips	14.11
Connection elements	11.3
Cord clips	12.8

Cord loops with metal clip	12.5
Cords on reel	12.8
Corner pockets, isosceles triangular	2.1
Corner pockets, paper	2.2
Corner pockets, unequal-sided	2.1
Corner pockets - customised	2.2
Corner pockets with welded-on pocket for business cards	2.2
Corner protectors	9.9
Corner puncher	9.9
Cover caps for binding screws	9.5
Covers for books and documents	14.4
Covers for books and documents - customised	14.4
Cover strips for A2 desk pads	4.3
Cover strips for desk pads - customised	4.3
Cover strips for file prongs	1.1
C-pockets	14.6
Credit card holders	14.3
Credit card holders - customised	14.4
C-Tragegriffe aus Metall	10.2
Cube magnets neodymium	7.4

D

Date indicators for desk calendar	4.2
Date indicators for three-month calendar with elastic cord	4.1
Date or file clips	4.5
Datums- oder Aktenklammern	4.5
Datumsweser für Tischkalender	4.2
Datumsweser mit Knebelgummi	4.1
Deckblätter DIN A1	18.1
Decken-Cliphaken mit Öse	11.8
Deckenspinne, Form „8“, verzinkt	11.9
Deckenspinne, verzinkt	11.9
Deko-Spring	11.3
Dental-Druckverschlussbeutel, PE-Folie 50 µm	15.4
Dental zip lock bags, PE foil, 50 micron	15.4
Digitrays	3.3
Dispenser box for adhesive discs	5.2
Dispenser for self-adhesive discs	5.2
Displayhaken	11.11
Display hooks	11.11
Display hooks and plates made of metal	10.3
Display hooks made of plastic	10.3
Display pockets	14.5
Display pockets - customised	14.6
Displayständer	11.12
Display strips	11.10
Document folders	14.7
Document folders - customised	14.7
Dokumententaschen	14.7
Dokumententaschen nach Kundenwunsch	14.7
Doppelseitige Klebepunkte, transparent	5.5
Doppelseitige Klebepunkte aus PE-Schaum, weiß	5.6
Doppelseitige Klebepunkte aus Reinacrylat, hochtransparent	5.6
Doppelseitige Klebepunkte nach Kundenwunsch	5.7
Doppelseitiges Hochleistungs-Klebeband 3M 9087	5.13
Doppelseitiges Hochleistungs-Klebeband 3M 9088	5.12
Doppelseitiges Hochleistungs-Klebeband, PET Folienträger	5.12
Doppelseitiges Hochleistungs-Klebeband, PVC Folienträger	5.13
Doppelseitiges Klebeband	5.10
Doppelseitiges Klebeband 3M 9086	5.11
Doppelseitiges Klebeband, stark / schwach	5.10
Doppelseitiges Klebeband Fingerlift	5.12
Doppelseitiges Klebeband High-Performance	5.11
Doppelseitiges Klebeband nach Kundenwunsch	5.14
Doppelseitiges Klebeband PE-Schaum	5.14
Doppelseitiges Reinacrylat-Klebeband	5.13
Doppelspiralfeder	1.2
Double-sided acrylic foam tape	5.13
Double-sided adhesive discs, transparent	5.5
Double-sided adhesive discs acrylic foam, highly transparent	5.6
Double-sided adhesive discs - customised	5.7
Double-sided adhesive discs PE foam, white	5.6
Double-sided adhesive tape	5.10
Double-sided adhesive tape 3M 9086	5.11
Double-sided adhesive tape, permanent / removable	5.10
Double-sided adhesive tape - customised	5.14
Double-sided adhesive tape high performance	5.11
Double-sided adhesive tape PE foam	5.14
Double-sided adhesive tape with fingerlift	5.12
Double-sided high performance adhesive tape 3M 9087	5.13
Double-sided high performance adhesive tape 3M 9088	5.12
Double-sided high performance adhesive tape, PET foil	5.12
Double-sided high performance adhesive tape, PVC foil	5.13
Double spiral spring	1.2
Drahtbinderücken, für DIN A4, 2:1 Teilung	8.3
Drahtbinderücken, für DIN A4, 3:1 Teilung	8.1
Drahtbinderücken, für DIN A5, 2:1 Teilung	8.4
Drahtbinderücken, für DIN A5, 3:1 Teilung	8.2
Drahtbinderücken auf Spule, 2:1 Teilung	8.6
Drahtbinderücken auf Spule, 3:1 Teilung	8.5
Drahtbinderücken nach Kundenwunsch	8.6
Drahtbügeltaschen	14.5
Drahtselbverbinder mit Drehverschluss	9.17
Drawstring bags, PE foil 50 micron	15.10
Dreiecktaschen, gleichschenkelig	2.1
Dreiecktaschen, ungleichschenkelig	2.1
Dreiecktaschen aus Papier	2.2
Dreiecktaschen mit aufgeschweißter Visitenkartentasche	2.2
Dreiecktaschen nach Kundenwunsch	2.2

Drilling cardboard	17.10
Druckknöpfe	10.4
Druckknopfstifte	10.5
Druckkösen	9.7
Druckverschlussbeutel, PE-Folie 50 µm	15.1
Druckverschlussbeutel, PE-Folie 90 µm	15.3
Druckverschlussbeutel, PP-Folie 50 µm	15.4

E

Einhängeösen für Kugelketten	9.17
Einpressköpfe für Buchschrauben	9.8
Einpressverschlüsse für Kugelketten	9.17
Einseitige Klebepunkte, transparent	5.1
Einseitige Klebepunkte nach Kundenwunsch	5.2
Elastic cord loops with knot	12.6
Elastic cord loops with knot on hang tag-machine-made	12.7
Elastic cord rings - customised	12.4
Elastic cord rings with metal ends	12.3
Elastic cords, cut-to-length	12.7
Elastikpuffer	17.4
Electronic dispenser for adhesive tapes A1200	5.10
Elektronischer Klebebandspeicher A1200	5.10
Eurolochaufhänger	11.1
Eurolochaufhänger nach Kundenwunsch	11.1
Extension screw tops	9.7
Extensions for binding-screws	9.3
Eyelets, brass-plated	9.12
Eyelets, nickel-plated	9.12
Eyelet setting tool for spindle press N4	9.13
Eyeletting machine M165	9.14
Eyeletting machine M80PU	9.15
Eyeletting machine M80T	9.14
Eyelet setting tool for eyeletting machine M165	9.14

F

Fabric adhesive discs	5.7
Falzbeine	17.10
Fälzband REGUdax RX	17.2
Fälzband REGUtaf H3	17.3
Fälzband REGUtex R	17.2
Farbige Klebepunkte	5.4
Fertigschleifen aus Gummizugschnur	12.6
Fertigschleifen maschinell an Anhängerkarten geknotet	12.7
Fertigschleifen mit Metallsplint	12.5
File folders - customised	17.7
File prongs	1.2
File prongs, self-adhesive	1.2
File prongs with additional file systems	1.1
File prongs without file system	1.1
Filing strips for wire and plastic loops binding	8.8
Flachbeutel nach Kundenwunsch	15.10
Flachgummi auf Rolle	12.5
Flachgummi mit zwei Metallsplinten	12.3
Flachkopfnägel mit Kappe	10.1
Flaschenringe	11.4
Flat bags - customised	15.10
Flat elastic cords on reel	12.5
Flat elastic cords with 2 metal T-ends	12.3
Fold back clips	17.1
Foldback-Klammern	17.1
Folding tool	17.10
Foliendeckblätter	8.7
Foliendeckblätter / Zuschnitte nach Kundenwunsch	8.7

G

Garment clips	10.6
Gehwegaufsteller, DIN A1	18.1
Gewebeklebeplättchen	5.7
Glue dots	5.8
Glue dots for tape gun	5.7
Gummiringe	12.10
Gummizugschnüre als Ring nach Kundenwunsch	12.4
Gummizugschnüre mit Metallsplint zum Ring geschlossen	12.3

H

Hakendeckleiste	1.4
Haken mit Schnur	11.6
Hammer tops for binding screws	9.8
Handabroller PREMIUM für Packbänder	5.15
Handabroller System für einseitige Klebepunkte	5.3
Hand dispenser system for single-side adhesive discs	5.3
Hand-held tape dispenser PREMIUM for packaging tapes	5.15
Handles made of plastic	10.2
Hängetaschen	14.5
Hängetaschen nach Kundenwunsch	14.6
Hanging tabs	11.1
Hanging tabs - customised	11.1
Header bags, OPP foil 30 micron	15.8
Headerbeutel, OPP-Folie 30 µm	15.8
Heftmechaniken mit Abheftvorrichtung	1.1
Heftmechaniken ohne Abheftvorrichtung	1.1
Hefttringe	9.10
Heftverschlüsse mit Schieberdeckleiste	1.5
Heftzungen	1.2
Heftzungen, selbstklebend	1.2
Heißlaminierttaschen	14.13



Glossar Glossary

Hook and loop fasteners, back to back	6.3
Hook and loop fasteners, self-adhesive	6.2
Hook and loop fasteners - coins	6.1
Hook and loop fasteners - coins, extra thin	6.1
Hook and loop fasteners - ellipses	6.1
Hook and loop fasteners - tape, self-adhesive	6.2
Hook and loop fasteners - tape for sewing	6.3
Hook and loop fasteners - tapes and coins - customised	6.4
Hook compressor bars	1.4
Hosenträgerclips	14.10
Hot laminating pouches	14.13

I	
ID lever clips	14.10
ID pockets	14.9
ID pockets - customised	14.9
ID pockets with coloured hanging edge	14.8
Index systems - customised	17.8
Index systems for A4	17.8

J	
JetSnabbs	11.6

K	
Kalenderaufhänger	4.7
Kalenderboxen	4.3
Kaltlaminiertfolien	14.12
Kaltlaminiertfolien nach Kundenwunsch	14.12
Kartenhalter	11.4
Kartenjojo aus Kunststoff	14.10
Key rings	9.11
Klappenbeutel nach Kundenwunsch	15.7
Klapprahmen	18.2
Klebeunkte mit Öse	11.8
Klebespender / Einwegrollen	5.8
Klemmschienen	13.1
Klemmschienen, selbstklebend	13.2
Klemmschienenhüllen	13.2
Klemmschienen mit Abheftfahne	13.1
Klemmschienen nach Kundenwunsch	13.2
Klettband, back to back	6.3
Klettbandabschnitte, selbstklebend	6.2
Klettbänder + Klettpunkte nach Kundenwunsch	6.4
Klettband, selbstklebend	6.2
Klettband zum Vernähen	6.3
Klett-Ellipsen	6.1
Klettpunkte	6.1
Klettpunkte, extra-dünn	6.1
Kombiklammern	14.11
Konfektionsklammern	10.6
Kordelklammern	12.8
Kordeln mit Einsteckbox	11.5
Kordeln mit Splinten	12.9
Kordelzugbeutel, PE-Folie 50 µm	15.10
Kugellisten, abgefrägt	9.16
Kugellisten auf Rolle	9.15
Kunststoffbuchschräuben	9.6
Kunststoffbuchschräuben mit Loch	9.8
Kunststoffdeckleisten	1.3
Kunststoff-Kollektionshaken	10.3
Kunststoffschlaufe für Gepäckanhänger	14.7

L	
Lanyards	14.10
Lanyard / Schlüsselband	14.10
Leather cord on reel	12.7
Lederkordel auf Rolle	12.7
Lesezeichenband	12.9
L-Folders - printed	14.2
L-Folders - unprinted	14.2
Line gauge	17.11
Locks	10.4
Loop pins / Stepped loop pins	11.5
Loop pins / Stepped loop pins	11.5
L-shaped sign holder	11.12
Luggage tags	14.7

M	
Magnetband, selbstklebend	7.4
Magnetclip für Namensschilder	14.12
Magnetic catch for badge holders	14.12
Magnete aus Neodym nach Kundenwunsch	7.4
Magnetic discs neodymium	7.1
Magnetic discs neodymium - customised	7.4
Magnetic discs "Ufo" neodymium	7.3
Magnetic frames with magnetic tape	18.2
Magnetic name badge holders	14.11
Magnetic pockets	14.8
Magnetic tape, self-adhesive	7.4
Magnetrahmen mit Magnetband	18.2
Magnettaschen	14.8
Merchandise rings	9.11
Metal discs	7.3
Metal file fittings	1.5

Metallolektionshaken & -platten	10.3
Metallösen, vermessigt	9.12
Metallösen, vernickelt	9.12
Metallronden	7.3
Mobile strings	11.8
Mobile-Verbinder	11.8
More suction cups	16.3

N	
Nägel für Musterbücher	10.1
Name badge holders	14.11
Namensschilder mit Kombiklammer	14.11
Namensschilder mit Magnet	14.11
Nylonclip	11.6
Nylon clip	11.6
Nylon cord reels	11.9
Nylonfaden auf Rolle	11.9

O	
OPP bags with flap for greeting cards, OPP foil 30 micron	15.6
OPP-Klappenbeutel für Glückwunschkarten, OPP-Folie 30 µm	15.6
Ös-Maschine M165	9.14
Ös-Maschine M80PU	9.15
Ös-Maschine M80T	9.14
Ös-Werkzeug für Maschine M165	9.14
Ös-Werkzeug für Spindelpresse N4	9.13

P	
Packaging tape	5.15
Packaging tape, reinforced	5.15
Packing list envelopes	15.11
Packing list envelopes - customised	15.11
Page marking ribbon	12.9
Paper drill bits	17.9
Papierbohrer	17.9
Parts page marking ribbon and cords - customised	12.9
Patternbook nails	10.1
Patternbook nails with cover	10.1
Pavement board for A1	18.1
PE bags with flap for mailing	15.2
PE-Flachbeutel	15.9
PE flat bags	15.9
PE-Klappenbeutel für den Versand	15.2
Pen-holders	17.6
Pfeilclip	4.6
Pfeilclips nach Kundenwunsch	4.6
Pillar press fasteners	10.5
Plakataufhänger	4.6
Plakatpieker	4.4
Plakatpieker nach Kundenwunsch	4.4
Plakattaschen	14.6
Plastic binding screws	9.6
Plastic binding screws with hole	9.8
Plastic compressor bars	1.3
Plastic fasteners with 2 eyelets	1.3
Plastic fasteners with 4 eyelets	1.4
Playing card boxes	17.5
Pockets for plastic fasteners with 2 eyelets	1.4
Poster hangers	4.6
Poster hanging rail sets	13.3
Poster hanging rail sets - customised	13.5
Poster hanging rail sets with clamping	13.4
Posterklemmschienen	13.3
Posterklemmschienen, aufklappbar	13.4
Posterklemmschienen Aluminium	13.5
Posterklemmschienen nach Kundenwunsch	13.5
Poster pins	4.4
Poster pins - customised	4.4
Poster pockets	14.6
PP bags with flap for mailing	15.5
PP-Flachbeutel, PP-Folie 40 µm	15.5
PP flat bags, PP foil 40 micron	15.5
PP foil protective covers	14.1
PP-Klappenbeutel für den Versand	15.5
PP-Klappenbeutel mit Warntext, PP-Folie 40 µm	15.4
PP-Packband	5.15
PP-Packband, fadenverstärkt	5.15
Press fasterness	10.4
Prospekthalter L-Aufsteller	11.12
Prospekthalter T-Aufsteller	11.12
Prospekthüllen / Ablagehüllen	14.1
Prospekthüllen nach Kundenwunsch	14.2
Protective covers	14.3
Protective covers - customised	14.3
PVC-Ringbücher	17.7
PVC-Schnellhefter nach Kundenwunsch	17.7

R	
Ratchet post fasteners with tube	10.6
Ratchet post fasteners with washer	10.6
Rechtecktaschen	2.3
Rechtecktaschen für Abheftvorrichtungen	1.4
Rectangular pockets	2.3
Regalbodenhalter für Wellpappe-Displays	11.13
Regalwipper, biegsam	11.2
Regalwipper, wippend	11.2
Register für DIN A4	17.8

Register nach Kundenwunsch	17.8
Ring binders	17.7
Ringmagnet als Datumswelser, inkl. Metallronden	4.2
Ringmagnete aus Neodym	7.3
Ring magnets neodymium	7.3
Ring magnets used as date indicators, incl. metal discs	4.2
Round elastic cords - on reels	12.4
Round elastic cords with 2 metal T-ends	12.1
Round elastic cords with 2 metal T-ends - customised	12.3
Rubber bands	12.10
Rückenschildtaschen	2.4
Rückenstütze	11.11
Rückwände	8.8
Rundgummi auf Rolle	12.4
Rundgummi mit 2 Metallsplinten	12.1
Rundgummi mit 2 Metallsplinten nach Kundenwunsch	12.3

S	
Sales labels	5.3
Saugnapfe mit Dorn zum Einstecken	16.1
Saugnapfe mit Kartenhalter	16.3
Saugnapfe mit Kopf	16.1
Saugnapfe mit M4-Gewinde	16.2
Suction cups with screw top (M4)	16.2
Saugnapfe mit Metallhaken	16.2
Saugnapfe mit Pfeilkopf	16.1
Schäfte für Kalenderaufhänger	4.7
Scheckkartenhüllen	14.3
Scheckkartenhüllen nach Kundenwunsch	14.4
Scheibenmagnete aus Neodym	7.1
Schiebeverschlussbeutel	15.10
Schlauchfolie	15.8
Schlauchmechaniken	1.5
Schlüsselringe	9.11
Schutzhüllen	14.3
Schutzhüllen nach Kundenwunsch	14.3
Schutzkanten für Schreibtschblocks DIN A2	4.3
Schutzkanten für Schreibtschblocks nach Kundenwunsch	4.3
Selbstklebende Abheftstreifen	17.3
Selbstklebende Abheftstreifen nach Kundenwunsch	17.4
Selbstklebende Scheibenmagnete aus Neodym	7.2
Self-adhesive filing strips	17.3
Self-adhesive filing strips - customised	17.4
Self-adhesive magnetic discs neodymium	7.2
Self-adhesive pads with eyelet	11.8
Self laminating cards	14.12
Self laminating cards - customised	14.12
Setting tool for book corners	9.10
S-Haken	11.7
Sheet protectors	14.1
sheet protectors - customised	14.2
Shelf clips	11.13
S-hooks	11.7
Sicherheitsfäden / Rasterschlaufe	11.5
Sichthüllen, bedruckt	14.2
Sichthüllen, unbedruckt	14.2
Sign-Clip - Preishalter mit Kugelgelenk	11.10
Sign-Clip - price holder with ball joint	11.10
Silikonlebepunkte	5.8
Silikonlebepunkte für Handabroller	5.7
Single-sided adhesive discs, transparent	5.1
Slide binder covers	13.2
Slide binders	13.1
Slide binders	13.5
Slide Binders, self-adhesive	13.2
Slide binders - customised	13.2
Slide binders with filing strip	13.1
Slide lock bags	15.10
Snap frame	18.2
Snap studs	9.7
Spacers	11.3
Spenderbox für einseitige Klebepunkte	5.2
Spender für Klebepunkte	5.2
Spezialschrauben	9.7
Spielkartenschachteln	17.5
Spindelpresse N4	9.13
Spindelpresse N4 Set	9.13
Spindle press N4	9.13
Spindle press N4 set	9.13
Spine label pockets	2.4
Spine Tape REGUdux RX	17.2
Spine tape REGUtaf H3	17.3
Spine tape REGUter X	17.2
Spring wobblers	11.3
Static date indicators	4.2
Statische Datumswelser	4.2
Steckverschlüsse	10.4
Stifthalter	17.6
Straight wire shafts for calendar hangers	4.7
Strap handle made of plastic	10.2
Suction cups with arrow head	16.1
Suction cups with card holder	16.3
Suction cups with metal hook	16.2
Suction cups with mushroom head	16.1
Suction cups with thumb tack	16.1
Suspended ceiling clip, "8" shape, galvanized	11.9
Suspended ceiling clip with eyelet	11.8
Suspended ceiling clip with eyelet, galvanized	11.9
Suspension hook	11.7
Swath straps	9.5



Glossar

Glossary

T

Tape dispenser	5.8
Tool-set for cap and socket of press fasteners	10.4
Tool-set for pillar and stud of the pillar press fasteners	10.5
Tragegriffe aus Kunststoff	10.2
Trageschlaufen	9.5
Trageschlaufen aus Kunststoff	10.2
Transferklebeband für ATG-System	5.9
Transfer tapes for ATG adhesive system	5.9
T-shaped sign holder	11.12
Tube mechanics	1.5
Tubularfoil	15.8

U

Ufo-Scheibenmagnete aus Neodym	7.3
Umschlaghüllen nach Kundenwunsch	14.4
Umschlaghüllen / Tickettaschen	14.4
Unterlegscheiben	9.5

V

Verbindungselemente	11.3
Verlängerungen für Buchschrauben	9.3
Visitenkartenboxen	17.5
Visitenkartenhalter	17.5
Visitenkartentaschen	2.4
Visitenkartentaschen / Rechtecktaschen nach Kundenwunsch	2.5

W

Wachspapierstreifen für Papierbohrer	17.10
Warenringe	9.11
Washers	9.5
Waxed paper stripes for paper drill bits	17.10
Weitere Saugnapfe	16.3
Werkzeug-Set für Kappen & Federteile der Druckknöpfe	10.4
Werkzeug-Set für Kunststoffschäfte & Einspitztifte der Druckknopfstifte	10.5
Wire bindings, for A4, 2:1 pitch	8.3
Wire bindings, for A4, 3:1 pitch	8.1

Wire bindings, for A5, 2:1 pitch	8.4
Wire bindings, for A5, 3:1 pitch	8.2
Wire bindings - customised	8.6
Wire bindings on spool, 2:1 pitch	8.6
Wire bindings on spool, 3:1 pitch	8.5
Wire framed pockets	14.5
Wire hangers with cord	11.6
Wire rope connector with screw	9.17
Wobblers	11.2
Wobblers, bendable	11.2
Würfelmagnete aus Neodym	7.4

Z

Zellenmaß (Typometer)	17.11
Zip lock bags, PE foil, 50 micron	15.1
Zip lock bags, PE foil, 90 micron	15.3
Zip lock bags with hole, PP foil, 50 micron	15.4

